



Fire detection and evacuation solutions that save lives.



ZoneSense Plus

Operation & Programming

MAN1544-5



Isolating a Zone

1. Indicator

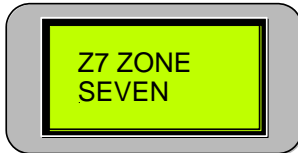

- **Zone Alarm** Indicator (flashing)
- **Common Alarm** Indicator (flashing)
- First **Zone in Alarm** is displayed on the LCD.

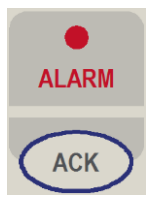

2. To **Isolate External Bell** press  

3. To **Isolate Warning System** press  

4. To **Acknowledge Alarm** press   *ALARM LED* will go steady.

5. To **Isolate Alarm** press   *ISOLATED LED* will be illuminated.

6. To **Reset Panel** press  

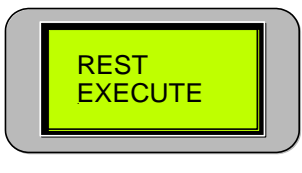
1st RESET LCD Screen Displayed 

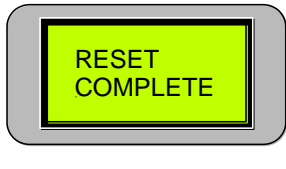
2nd. RESET LCD Screen Displayed 

Isolating a Zone

Example below isolates Zone 2)

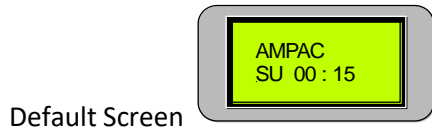

Moving to the ISOLATE MENU

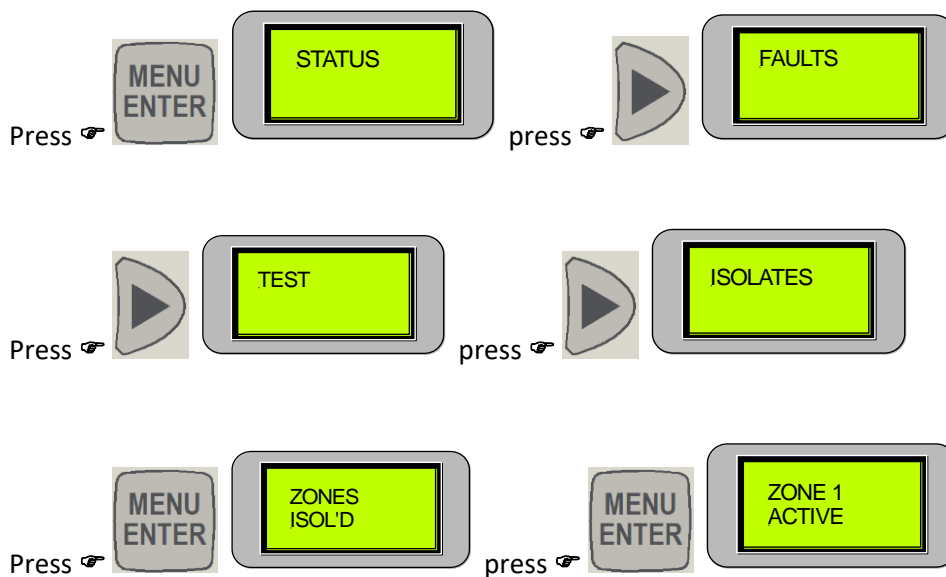

Moving to ZONE 2

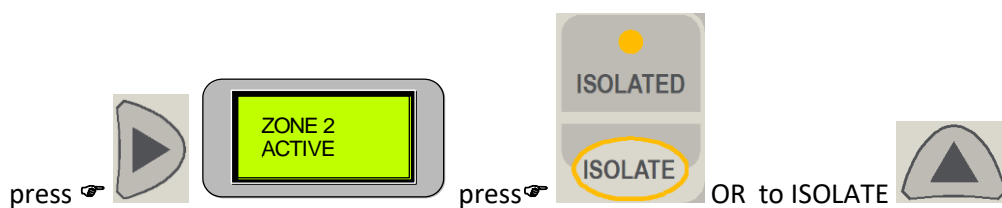

Zone 2 accessed and ISOLATED - To DE-ISOLATE press the ISOLATE or DOWN button.

Note: If a Zone ISOLATE has been initiated the ZONE and the COMMON indicator LED's are illuminated.

Contents

1	About This Manual	6
1.1	Introduction	6
1.2	General Requirements.....	6
1.3	References	6
1.4	Symbols.....	6
2	Controls & Indicators – Front Panel.....	7
2.1	System Controls & Indicators.....	7
2.2	Level of Access	7
2.3	FireFighter Facility Controls and Indicators	8
2.4	System Controls.....	9
2.5	Normal Operation	9
2.6	Indicators – Front Panel.....	10
2.6.1	Status Indicators	10
2.6.2	Zone Indicators	11
2.7	Liquid Crystal Display.....	11
2.8	Main Menu.....	12
3	Level 1 Access	13
3.1	STATUS.....	13
3.1.1	Outputs	14
3.1.2	Brigade	14
3.1.3	Relays.....	15
3.1.4	Fire Fan.....	15
3.1.5	Agent.....	15
3.1.6	Sounders	15
3.1.7	Inputs	16
3.1.8	Voltage	16
3.1.9	Software	16
3.2	FAULTS.....	17
4	Level 2 Access	18
4.1	Tests.....	18
4.1.1	Alarm Test	18
4.1.2	Fault Test.....	19
4.1.3	Walk Test.....	19
4.1.4	Lamp Test	20
4.1.5	Battery Test	20
4.1.6	Sounder Tests of each Sounder	20
4.2	Isolates.....	21
4.2.1	Main Control Board Zone, Relay Board or Sounder Board Isolates.....	21
4.2.2	Main Control Board Outputs Isolates	22
5	Level 3 Access Programming	23
5.1	Password Entry.....	23
5.2	System	24
5.2.1	Buzzer.....	24
5.2.2	LED Annunciator Master (LAM)	25
5.2.3	Code	25
5.3	Program	26
5.3.1	Zones.....	26
5.3.2	Clock.....	27
5.3.3	MCP Zone	27

5.3.4	Outputs	28
5.3.5	Relays	29
5.3.6	Fire Fan.....	30
5.3.7	Agent.....	32
5.3.8	Sounders	33
5.3.9	Indicate	33
5.3.10	Display.....	34
5.3.11	Zone Labels.....	34
5.3.12	End Of Line (EOL)	34
5.3.13	Zone S/C.....	34
6	Agent Release.....	35
6.1	Controls.....	35
6.2	LocalControl Station	36
6.3	Common Agent Release Card & LCS Indicators	37
6.4	Agent Release Operation	39
6.5	Manual Mode.....	39
6.6	Auto Mode	40
6.6.1	Single Zone Activation.....	40
6.6.2	Dual Zone Activation.....	41
6.6.3	Manual Activation.....	43
6.7	Service Switch	43
6.8	Lock-Off Valve	43
6.9	Fault Supervision	44
6.10	Isolation	44
6.11	System Inoperative Ouput	44
6.12	Manual Mechanical Release of the Agent	45
6.13	Monitoring of the Pressure Switch.....	45
7	Warning Device	46
8	Appendix A: AS4428 Menu Structure & Programming	49
9	Trouble Shooting Chart	54
10	Certification Information.....	55
11	Glossary of Terms	56
12	Definitions.....	57

1 About This Manual

1.1 Introduction

This manual contains all the information required to install, and operate the **ZoneSense PLUS - AR** Fire Alarm Control Panel (FACP) and is only available to and for the use of personnel engaged in its installation, commissioning and operation.

Using 3 levels of access the ZoneSense PLUS - AR Fire Alarm Control Panel (FACP) is controlled and programmed through the keypad on the front panel.

 **Note:** To assist in the programming process the screens or Menus presented to the operator are diagrammatically shown as an Appendix at the end of this document.

1.2 General Requirements

The **ZoneSense PLUS - AR** FACP has been designed and manufactured from high quality commercial components so as to comply with major world standards. To ensure these standards are not compromised in any way installation staff and operators should;

- Be qualified and trained for the task they undertake;
- Be familiar with the contents of this manual prior to the installation, commissioning or operation of a **ZoneSense PLUS - AR** control system;
- Observe anti-static pre-cautions at all times; and
- Be aware that if a problem is encountered or there is any doubt with respect to the operational parameters of the installation the supplier should be contacted.

1.3 References

ZoneSense PLUS Technical Manual

ZoneSense PLUS – AR Operation and Programming

Australian Standards:

AS4214 – Gaseous Fire Extinguishing Systems

AS4428 - Fire Detection, Warning, Control and Intercom Systems – Control and Indicating Equipment. Part 1 and Part 5

1.4 Symbols

 Important operational information

 **Note:** Configuration considerations



Observe antistatic precautions



Mains supply earth



DANGER mains supply present

2 Controls & Indicators – Front Panel

2.1 System Controls & Indicators

The front panel controls for the ZoneSense PLUS - AR consists of twelve push buttons and an optional Normal / Enabled key switch.

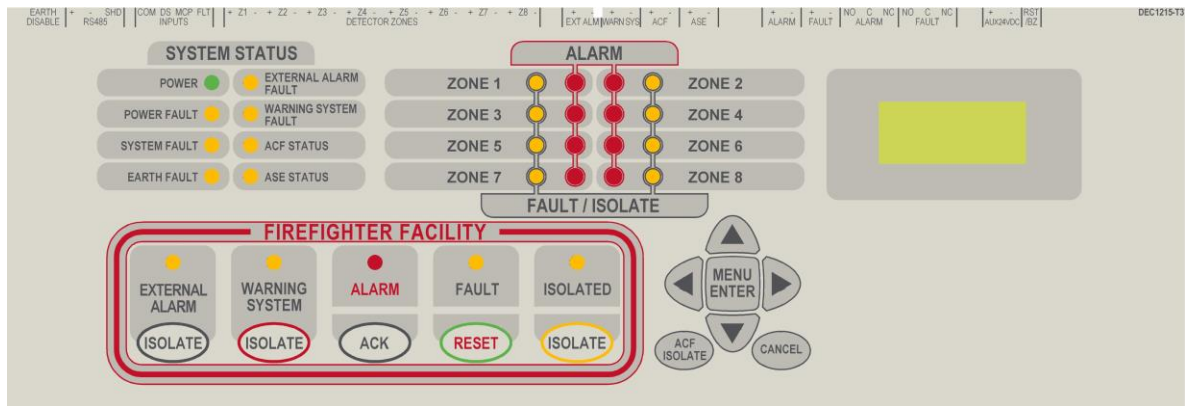

Figure 1: AS4428 8 Zone Front Panel Controls and Indicators

2.2 Level of Access

Access to the FACP is restricted to three levels of authorisation.

AS4428 requires panel controls to be behind a 003 keyed door.

Level 1: (No Password Required)

By pressing the Menu button access to Level 1 is gained to the read only FAULT, STATUS display and Password entry menu.

Level 2 (If set Pre-commissioning Password is factory set at 2222)

To gain access to the Level 2 TEST and ISOLATE MENUS a fixed 4 digit Level 2 Password or a key to the control ENABLE switch is required.

Level3: (Pre-commissioning Password factory set at 3333)

Level 3 SYSTEM and PROGRAM menus can only be accessed by a set Level 3 password that can not be deleted.

Panels fitted with a key switch have access to level 2 with the switch enabled and then 3 via the password. Without the key switch access to level 2 is by opening the door and then to level 3 via the password.



Note: If the keypad controls are not used for a period of 2 minutes the display will return to the default screen.

2.3 FireFighter Facility Controls and Indicators



Note: Any of the buttons within the FireFighter Facility will act as a buzzer mute.

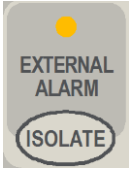

External Alarm Isolate Is a dedicated control used to isolate (turn off) the “External Alarms” output and is not over ridden by any other condition. The LCD Screen will display the isolate if the ISOLATES / OUTPUTS menu is selected.

External Alarm Isolate – Amber Illuminated by the isolation of the “External Bell” output. This indicator is integral with the “External Bell Isolate” button.



Warning System Isolate Isolates (turns off) the “Warning System” output and is not over ridden by any other condition. The LCD Screen will display the WARNING SYSTEM is isolated if the ISOLATE / OUTPUTS menu is selected.

Warning System Isolate – Amber Illuminated by the isolation of the ‘Warning System” output. This indicator is integral with the “Warning System Isolate” button.

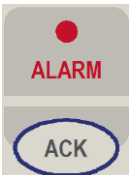

Acknowledge On Alarm the Alarm LED and Zone Alarm LED will flash and the Buzzer will sound. By pressing Acknowledge the LED’s become steady, the Buzzer will be silenced and a zone/s can be Isolated or Reset.

Alarm – Red: Alarm is a general fire indicator that flashes until all alarms have been acknowledged or isolated. Once acknowledged it is lit steady until reset.

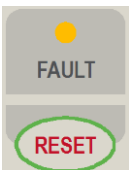

Reset The Reset is used to return the control panel back to a normal state from the fire alarm condition. The Reset button is not to be used for any other purpose and will not reset an isolated condition.

Fault – Amber Is a general fault indicator that flashes if a fault is present on any part of the system.



Isolate Isolates or De - isolates a Zone which has been selected using the Zone Select Menu. Inhibits Alarm and Fault signalling outputs but not LED indications generated by the corresponding zone. Isolates all acknowledged alarms in a single operation and operates the fault buzzer if an isolate condition still exists on the panel after 8 hours. The LCD screens below show an example.

Isolate – Amber Is a general isolate indicator that is illuminated if a Zone, Bell, Warning System or ACF is isolated.

2.4 System Controls

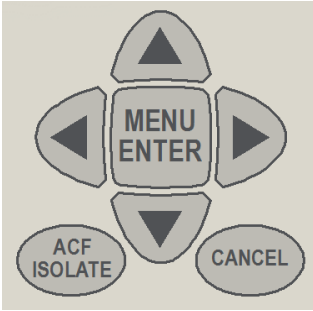

Enter or **Menu** is used to access the various menus and sub-menus and update the program once the control settings have been set within a menu.



Move Left allows the operator to move left through a menu or the options to be set.



Move Right allows the operator to move right through a menu or the options to be set



Move Up takes the cursor up through the menus and / or options.



Move Down takes the cursor down through the menus and / or options.

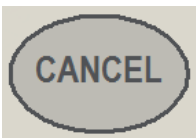

Cancel is used to return to the previous menu.



ACF Isolate

2.5 Normal Operation

During normal operation the panel LCD default screen will display a name, the day and the time.

To access the Main Menu press Enter.

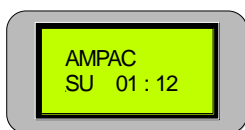

Abbreviations: SU - SUNDAY
 MO - MONDAY
 TU - TUESDAY
 WE - WEDNESDAY
 TH - THURSDAY
 FR - FRIDAY
 SA - SATURDAY

2.6 Indicators – Front Panel

All indicators are clearly visible at all times. If flashing indicators are used the on / off periods are >0.25 seconds and the flash frequencies are not less than:





- 1Hz for Alarm indications.
- 0.2Hz for Fault indications.

If the same LED is used to indicate both fault and isolate conditions the LED will flash for fault and be steady for isolate with isolate having priority.

All indicators are steady unless otherwise stated.

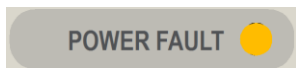
2.6.1 Status Indicators

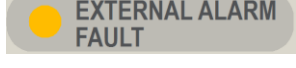
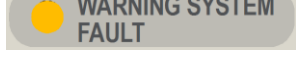
There are eight indicators within the system status area of the front panel;

- | | |
|---|--|
|  | Power – Green Indicates mains power is available to the FACP. |
|  | Power Fault – Yellow Common fault to either the mains or DC system power supply. |
|  | System Fault – Yellow Indicates a failure of the FACP to provide mandatory functions, (software failure). |
|  | Earth Fault – Yellow Is an indication only to warn of a fault to earth that may affect a mandatory function. A plug jumper facility is provided to disable the earth monitoring if necessary |
|  | External Alarm Fault – Yellow Illuminates when an open or short circuit fault condition is detected on the external alarm circuit. |
|  | Warning System Fault – Yellow Illuminated by a fault condition of the warning system output. |
|  | ACF Status - Fault / Isolate – Yellow Illuminates when the ACF output is in fault (flashing) or isolated (steady). |
|  | ASE Status - Fault – Yellow Illuminates when a fault condition is detected on the ASE circuit. |

2.6.2 Zone Indicators

There are two indicators for each alarm zone fitted to the panel.

Zone Alarm – Red The indicators show individual zone/s in alarm. On alarm the LED will flash until the alarm is acknowledged. Once acknowledged the LED will be continuously illuminated until the panel is reset.

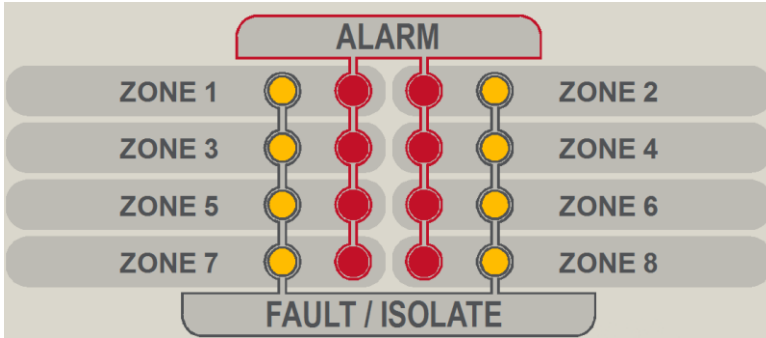

Zone Fault / Isolate – Amber Illuminated by:

A fault condition on an individual zone (flashing);

Isolating a zone/s, illuminated steady unless in fault, then flashes.

A zone in fault that has already been isolated flashes at a different rate than when only in fault, the off period is the same with the on period being 3 times that of the fault flash rate.

2.7 Liquid Crystal Display

The panel is fitted with an 8 x 2 LCD. Its primary purpose is to display Zone alarm / fault / isolate information and prompts for system commands come programming. Alarm, Fault and Isolate information is accessed through the Main Menu. When the FACP is in its normal state a default screen will be displayed. Examples of LCD Displays are;

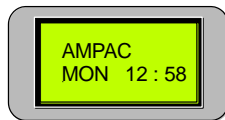

Default Screen

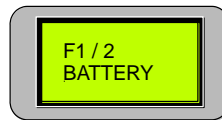

Fault 1 off 2 Battery Fault

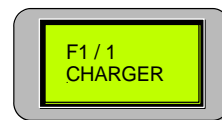

Fault 1 off 1 Charger or Power Fault



Note: Some of the following sub-menus will not be available if the facility has not been installed, eg. Brigade, Relays, Fire Fan, Agent Release, Sounder, and / or Input boards / cards / modules. If one of the above ancillary facilities has been fitted retrospectively it must be appropriately programmed into the FACP via the SYSTEM and PROGRAM MENUS, if not a System Fault will be indicated. Once programmed into the FACP the ancillary facility is monitored in the normal way. Refer to the SYSTEM and PROGRAM MENU structure diagrams in the Appendix for more information.

Press **ENTER** to access **MAIN MENU**

2.8 Main Menu

The Main Menu consists of;

		2 Activate Control		Level 3 Enter Password	
<u>STATUS</u>	<u>FAULTS</u>	<u>TEST</u>	<u>DISABLES</u>	<u>SYSTEM</u>	<u>PROGRAM</u>



Press the

Move Right /



Move Left key to move through the menu.



Press

to access the sub – menus.



Move Right to access STATUS

3 Level 1 Access

Is a read only menu that allows the operator to reset latched Ancillary Control Facility outputs (IF FITTED); In the event an ancillary device trips out or is operated for some reason the latching control of the device has to be reset to re-establish normal functionality of that device. Press  to reset. The LCD will display the reset progress as seen below and then return to the Default Screen.

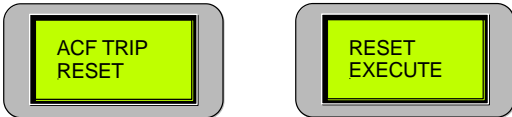



 **Note:** Use Cancel at any time to step back out of the current Menu.

- Interrogate the panel to determine the state of selected outputs; STATUS
- View any faults that may be present on the FACP. FAULTS

 **Note:** Use Cancel at any time to step back out of the current Menu.

3.1 STATUS



Status allows the operator to select and view the current state/operating conditions of the active components listed in the following sub-menu.

Press  to view the Status Menu. Press  Move Right to move through the menu or  to access the Status sub-menus.

 **Note:** The sub-menu headings are in *Italic*.

O/Ps	Brigade	Relays	Fire Fan	Agent	Sndrs	I/Ps	Voltage	Software
<i>Bell</i>	<i>Alarm 1</i>	<i>Relays 1 to 8</i>	<i>Fan 1 to 4</i>	<i>On</i>	<i>Sndrs 1 to 8</i>	<i>1 to 16</i>	<i>Battery volts</i>	<i>Version</i>
<i>Warn Sys</i>	<i>Fault</i>	<i>On</i>	<i>On</i>	<i>Normal</i>	<i>On</i>	<i>On</i>	<i>Charger volts</i>	
<i>ACF</i>	<i>Isolate</i>	<i>Off</i>	<i>Off</i>	<i>Release</i>	<i>Off</i>	<i>Off</i>	<i>System Volts</i>	
<i>ASE</i>	<i>Bat Fail</i>	<i>Isolate</i>		<i>Sequence</i>	<i>Normal</i>			
<i>Alarm</i>	<i>Alarm 2</i>				<i>Off Fault</i>			
<i>Fault</i>								
Note: these screens are only available if the card, module or board is fitted to the FACP and it is set to Yes in the System Menu								

3.1.1 Outputs

Press  then  Move Right or  Move Left to view the status of the monitored Bell, Warning System, ACF, ASE, Alarm or Fault Outputs on the Main Control Board.

The LCD readout will indicate if the selected Output is:

On and Normal, or Off and Normal, or Off and Isolated, or On and Isolated, or Output is On and in Fault, or Off and in Fault.

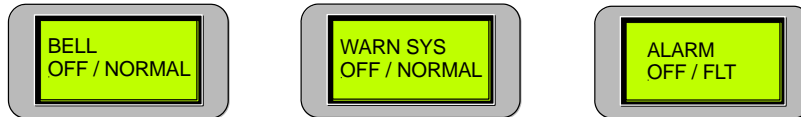







Figure 2: Sample Output Screens

Meaning: The O/P is either On (activated) and Normal, or Off (de- activated) and Normal, or On (activated) and Isolated, or Off (de- activated) and Isolated.

3.1.2 Brigade

Press  then  Move Right or  Move Left to view the Brigade screen. Press  then  Move Right or  Move Left to view the Status of the Alarm 1 & 2, Fault, Isolate and Battery Fail monitoring on the Brigade Board.

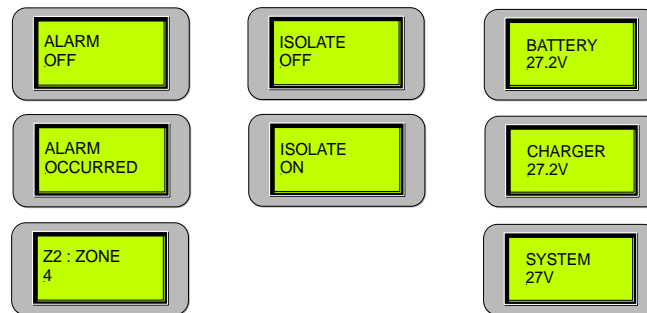

Figure 3: Sample Brigade Screen

3.1.3 Relays



Press Enter then  Move Left or  Move Right to select the required Relay (1 – 8). The LCD read out for each relay on the Relay Board will indicate if the selected relay is On, Off or Isolated OR Press  Move right to access Fire Fan.



Figure 4: Sample Relay Screens

Meaning: A Relay is either On (activated), or Off (deactivated) or Isolated.

Note: The relay's control function is identified in the configuration documentation

3.1.4 Fire Fan

Press  then  Move Right or  Move Left to select view Fire Fan control status 1 to 4.

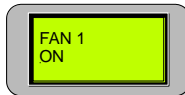

Figure 5: Sample Fire Fan Screen

3.1.5 Agent







Press  then  Move Left or  Move Right to select the Agent OR press  Move right to access Sounders. The LCD indicates the Agent Release Board status / release progress.



Figure 6: Sample Agent Normal, Isolated Release in Stage 1 Screens

3.1.6 Sounders

Press Enter then  Move Left or  Move Right to select the required Sounder (1–8). OR Press  Move right to access Voltage. The LCD indicates if the selected Sounder Board output is;

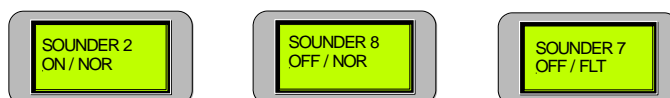





Figure 7: Sample Sounders Screens

Meaning: Off and Normal, or Off and in Fault, or On and Normal, or On and in Fault, or Isolated and Normal, or Isolated and in Fault.

3.1.7 Inputs

Press  then  Move Right or  Move Left to view the status of each input (1 to 16) on the Input Board.

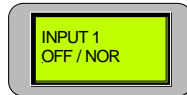





Figure 8: Sample Input Screens

3.1.8 Voltage

Press  Move right to access Software OR press  and the Battery Voltage will be displayed, pressing  Move Right will display the Charger Voltage (approx 27.2volts), pressing  Move Right again will display the System Voltage.

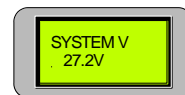
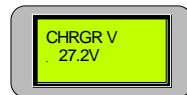
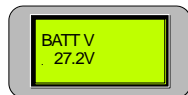
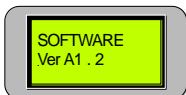

Figure 9: Sample Voltage Screens

3.1.9 Software





Displays the installed version of software. (This is for information only)



End of Sub - Menu

Returning to STATUS in the Main Menu  Move Right to access FAULTS

3.2 FAULTS

Pressing  will display all faults in a sequential order. If there is more than one fault on the system the operator can scroll through each fault by using the  Move Left and  Right keys. Pressing  again at each Fault will display more detailed information.

Accessing information on 2 Faults



Or

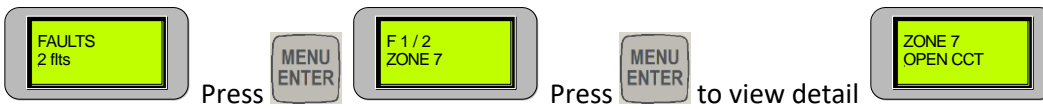

LCD Screen Examples of System Status Faults

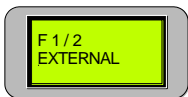

System Fault, SYSTEM FAULT LED flashing

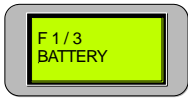

Battery Fault, POWER FAULT LED and POWER LED on

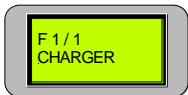

Power Fault, POWER FAULT LED and POWER LED off

 **Note:** *FAULT LED will be flashing (for all 3 FAULTS)*

4 Level 2 Access

At this level the operator is expected to have undergone training so as to be able to;

- Test crucial elements of the system and; TEST
- Isolate dedicated facilities that may be in fault. ISOLATE

In the Main Menu From FAULTS  Move Right for TEST





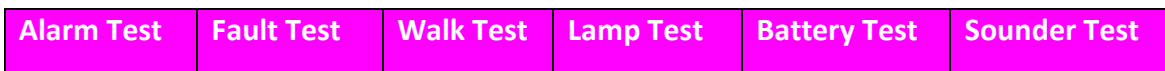

4.1 Tests

Press **Enter** to access the available menus



The available menus are;



 **Note:** The Sounder Test Menu is only displayed if it is installed and set to active in the System Menu.

To initiate one of the above tests press the  Move Right /  Move Left key to move through the menu. Press , then select the Zone by using the  Move Up and / or  Move Down keys until the desired Zone number is displayed, press  to start the test.

4.1.1 Alarm Test

Once the test is commenced the Buzzer will turn on and off and the common Alarm and Zone Alarm LED's will flash. Press , the Buzzer will be silenced and the common Alarm and Zone Alarm LED's will be steady. Press  to return the panel to normal. The LCD will indicate the alarm has occurred and then toggle to display the Zone and descriptor of that Zone.

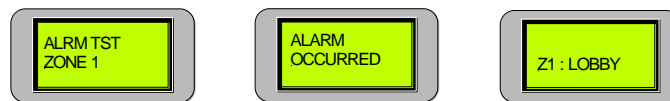



Figure 10: Alarm LCD Sequence

 **Note:** If a Zone has been programmed to be;

NON LATCHING the panel will only go into alarm for 5 seconds and then automatically reset.

Self Resetting (SREST 60) the panel will go into alarm for 60 seconds and then automatically reset.

4.1.2 Fault Test



Once the test is commenced the Buzzer will rapidly turn on and off and the common Fault and Zone Fault LED's will flash. Press , the Buzzer will be silenced and the common Fault and Zone Fault LED's will continue to flash. Press  to return the panel to normal. The LCD will indicate the Fault Test has been implemented on the selected Zone.









Figure 11: Fault Test Zone 1 Screen

4.1.3 Walk Test





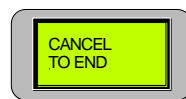
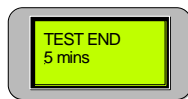
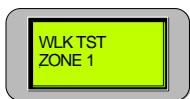

Note: The Brigade, Agent Release and any other system specific signalling should be ISOLATED prior to initiating this test.

A Walk Test, sets the Zone to Non latching and allows the technician to test detectors and MCP's on that Zone. When a detector or MCP is put into alarm the "Alarm Outputs" will operate, the corresponding "Zone Alarm" LED will flash and the buzzer will sound.

The Zone will stay in Alarm until the MCP, or detector under test is reset or, the test is aborted by pressing Cancel or, the test times out. The time out period can be set by pressing  once the Zone has been selected and using the  Move Up and / or  Move Down keys to select the required time for the test. The default time is 5 minutes but can be adjusted from 1 to 20 minutes by again using the  Move Up and / or  Move Down keys to select the required time and then pressing .





Press  Enter Time   

In the TEST END screen the operator has ten (10) seconds to enter the time before the test will commence OR, the test can be started by pressing .

Only one zone at a time can be in test mode, all other zones will operate as normal.

The LCD will display which Zone is the in Walk Test mode.

4.1.4 Lamp Test

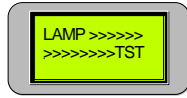
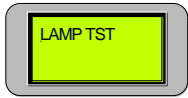

Press the  Move Right and / or  Move Left key to move to the Lamp Test menu, press  and each LED on the panel will be sequentially turned on for one second and then off again. The Buzzer will sound at the start and completion of the test.



Press  Indicates the Test Progress Test Successful

 **Note:** The operator has to visually confirm each LED illuminates.





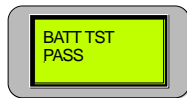
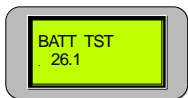

4.1.5 Battery Test

Press the  Move Right and / or  Move Left key to move to the Battery Test menu, Press  and the Battery Test will commence, that is the Charger will be disconnected from the battery and a dummy load placed across the battery for 60 seconds. The battery voltage should be above that specified (23.5 volts) at the end of the testing period, if not a FAILED message is displayed.



Battery Test Underway Test Successful Battery Failure

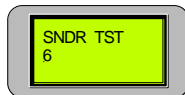
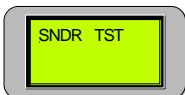

4.1.6 Sounder Tests of each Sounder

Press the  Move Right and / or  Move Left key to move to the Sounder Test menu, press , then select the Sounder by using the  Move Up and / or  Move Down keys until the desired Sounder number is displayed, press  to start the test and  to turn it off.



Press    Sounder 6 Selected  to Start  to Stop





4.2 Isolates

To display the number of Isolates press  to access the menus then  Move Left or  Move Right to select the required menu. The number of isolates will be displayed for each step.

<u>Zone [Main Brd]</u>	<u>Monitored Outputs</u>	<u>Relay [Relay Brd]</u>	<u>Sounder [Sndr Brd]</u>
Zones 1 to 8 are Active or Isolated	[Main Brd] Bell, Warn Sys ACF ASE, Alarm, Fault	Relays 1 to 8 are Active or Isolated	Sounders 1 to 8 are Active or Isolated
<i>Only available if relays and or sounders are installed</i>			

Note: The Relay and Sounder Isolate Menus are only displayed if the boards are installed in the FACP and set to active in the System Menu.

4.2.1 Main Control Board Zone, Relay Board or Sounder Board Isolates

Press **Enter** and use the  Move Left or  Move Right keys to select the Zone, Relay or Sounder number then the  Move up to key isolate or  Move Down key to make active (set) the required Zone, Relay or Sounder.

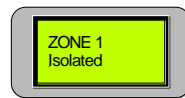
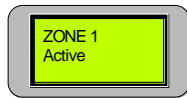

Press **Enter** ◀ ▶ Select Zone Number set, ▼ Active or ▲ Isolated





Note: X denotes the Zone number, substitute Relay or Sounder for those menus.

If a Zone or Zones are Isolated the Isolate LED for that Zone and the common Isolated LED will be illuminated. If a Relay or Relays, Sounder or Sounders are isolated only the common Isolate LED will be illuminated. The Isolate can be deactivated by pressing ISOLATE / DE-ISOLATE while in the Output menu or repeating the steps above to de-isolate (make Active) individual Zones.

4.2.2 Main Control Board Outputs Isolates

Press **Enter** to access the Isolate – Main Control Board Monitored Outputs sub-menus as seen below

<i>Bell</i>	<i>Warn Sys</i>	<i>ACF</i>	<i>ASE</i>	<i>Alarm</i>	<i>Fault</i>
-------------	-----------------	------------	------------	--------------	--------------

Use the  Move Right or  Move Left keys to select the required menu and the  Move Up key to Isolate or  the Move Down key to active.

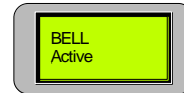
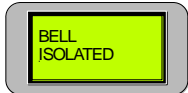

If the:

- Bell is Isolated the External Bell LED will be illuminated.
- Warning System is Isolated the Warning System LED will be illuminated.
- ACF is Isolated the ACF Fault / Isolate LED will be illuminated.
- ASE, Alarm or Fault Output is Isolated the common Isolated LED will be illuminated.



Press  to back out of the Isolate Menu to the Main Menu.

Move Right to Enter the PASSWORD for level 3 Access

Wait for the screen to return to ACF TRIP and use  Move Right to scroll to the **SYSTEM** or **PROGRAM** Menu



Note: Press  at the end of each selection to update the program.

5 Level 3 Access Programming







Level 3 is a technical level that allows a technician to;

SYSTEM , Initialise the FACP so it is capable of recognising how the system is constructed; and

PROGRAM program how it will present information as well as how it will react to a change of state of an input and / or output

5.1 Password Entry

Returning to Faults in the Main Menu, Move Right for Password Entry to Level 3. OR if entering the programming from the Default Screen press the  Move Left key to directly access from the ACF Reset Menu.

Press  and a flashing cursor will appear below the word PASSWORD. By using the  Move up and  Move down keys the number on the screen will be incremented accordingly. Once the first password number has been set use the  Move right key to move to the next number to be set. This operation has to be repeated four times as the PASSWORD is a four digit code. If a number is incorrect it can be changed by using the  Move Left and  Right keys to position the cursor over the incorrect number. Once the four numbers have been set pressing  initiates the verification of the PASSWORD that has been entered. An incorrect PASSWORD will be displayed as REJECTED and return the operator to the first menu of Level 1 access.

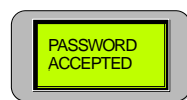
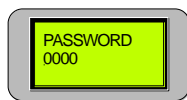
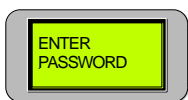

Press  Enter **Password** Correct Password Entry

If the PASSWORD is accepted the screen will display ACF TRIP RESET. Use the  Right keys to move through the menu to SYSTEM OR PROGRAM.

 **Note:** The operator has 10 seconds to complete Password entry. Failure to enter the Password in this time results in the panel reverting to the default screen.

 **Note:** The System and Program Menus are not accessible if an Alarm condition exists even if the correct Password is entered.

5.2 System

After entering the Level 3 Password and moving to the SYSTEM menu press  and the;
 Zone ISOLATE LED's will illuminate;
 Common ISOLATED LED will flash; and the
 LCD will display;

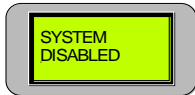



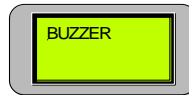

SYSTEM DISABLED



BUZZER

And then

Ignoring Buzzer, Mimic and Code menus (explained below) use the  Move Right or  Move Left keys to move through the menu and the  Move Up key to set YES or  Move Down key to set No. Yes meaning the facility / board / card has been fitted to the FACP and will be programmed in the Programming Menu, No meaning it has not been fitted and will not appear in the Programming Menu.

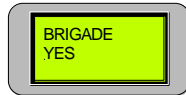
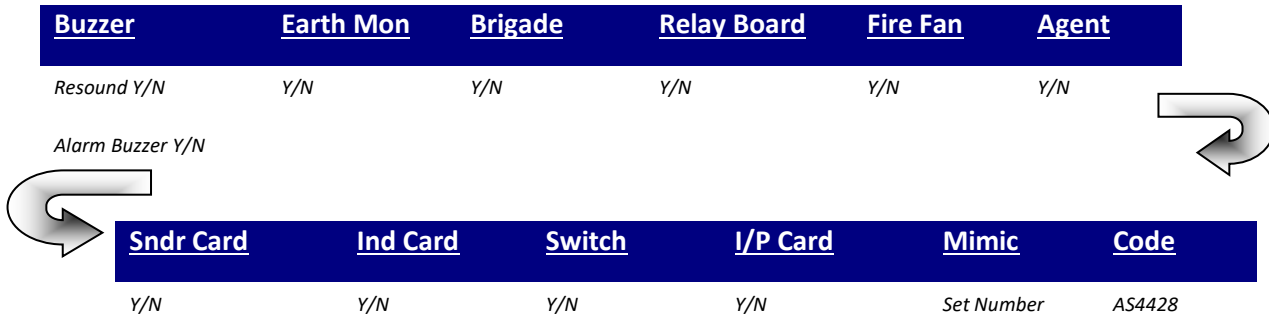







Figure 12: Typical Screen examples of the System Menu



Note: Buzzer is the only option that has a sub-menu where the operator is required to make a selection from the options offered.

5.2.1 Buzzer

Press  to access the Sub – Menu then the  Move Left or  Move Right key to select either; **Resound**, **Alarm** or **Alarm Buzzer** then . Set the **Resound**, **Alarm** by using the  Move Up key to Yes (activate on alarm) or  Move Down key for No (not activate on alarm).

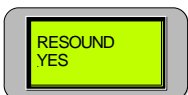

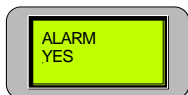

Resound Set to YES

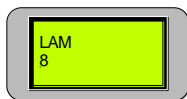

Alarm Set to YES

5.2.2 LED Annunciator Master (LAM)





This tells the FACP how many LAM's are on the system hence how many to look for. Set the number by using the  Move Down and / or  Move Up keys to increment to the desired number 0 to 8 (maximum of 8).

5.2.3 Code

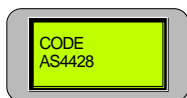
Code is the National Standard the Panel complies with. This is factory set and can not be altered.



Back out to the Main Menu using the  key and move from the **SYSTEMS** Menu to the **PROGRAM** Menu using the  Move Right key. When the  key is pressed the LCD will display;

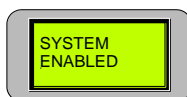

for one second and all the Isolate LED's will be turned off.

5.3 Program

 **Note:** From the Zones Menu use the  Move Right key to advance through the **PROGRAM** Menu.

Pressing Enter to access the Program Menu will again disable the panel and the LED's will illuminate as they did in the Systems Menu.

The **PROGRAM** Menu consists of;

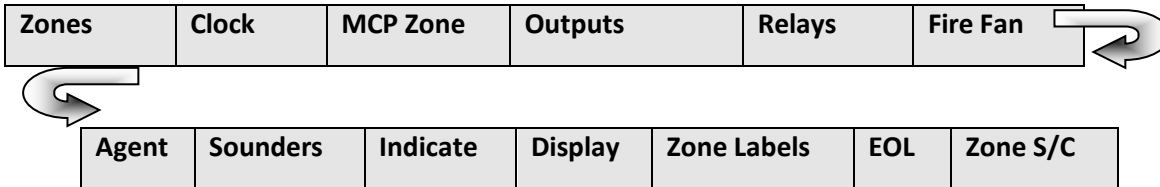

5.3.1 Zones

Press  and the Zones Menu will be displayed on the LCD screen. Pressing  again will access the Zones sub menu where first the  Move Right and  Move Left keys are used to select the Zone number and the  Move Up and



Figure 13: Sample Zone Screens



Move Down keys are used to set the functions within that Zone. The functions are;

Normal

Normal is selected if the Zone is required to initiate an alarm and latch until reset.

AVF

If AVF, (Alarm Verification Facility) is set active a delay and re-sampling period is initiated to confirm an alarm condition actually exists on that Zone.

Non Latch

Non Latch if set will initiate an alarm only when the Zone is in alarm.

SRESET 60

Resets the Zone 60 seconds after the Zone comes out of alarm.

Agent 1	Agent 2	Agent 3	Agent 4
----------------	----------------	----------------	----------------

If only one trigger zone is allocated a zone then the system will be activated by one zone only.

Any trigger zone may be allocated to any zone. However when a trigger zone has been allocated eg T1 to zone 1 then only the remaining trigger zones T2, T3 or T4 are each available to be allocated one of the remaining detector zones.

If multiple trigger zones are allocated e.g. T1 - Z1, T2 – Z2, T3 – Z3 then any one zone in alarm will operate the first stage and any other zone in alarm will operate the second stage.











Setting up;

Determine the number of trigger zones (1 to 4) that will be required to activate the agent release. Relate this requirement to the conditions outlined above

In the Zone Programming Menu select T1, 2, 3, or 4 and enter the zone numbers. Press  to update the program.



Note: Press Cancel to return to the Zones Menu and then  Move Right to access the Clock menu.

5.3.2 Clock

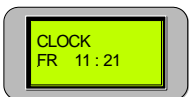

To set the day and time press  and the day will be highlighted. Use the  Move Up or  Move Down keys to step through the days of the week, then the  Move Right key to access the hours and minutes. To access each digit use the  Move Right and  Move Left keys and to increment each digit use the  Move Up and  Move Down keys. Press  to set the time and then  Move Right To access the MCP Zone Menu.

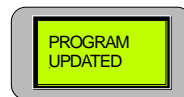
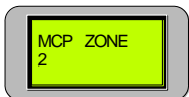

5.3.3 MCP Zone

Press **Enter** to assign the MCP to a Zone using the  Move Up and / or  Move Down keys to select the Zone, (1- 8) that the MCP will be assigned to then  to update the Program.









Press  to return to the MCP Zone menu and then  Move Right to access the Outputs Menu.

5.3.4 Outputs

To assign Zones that will activate the monitored outputs press  and a sub menu will be made available for programming. The default condition for each output is all Zones will activate all outputs. The sub menu consists of;

Output							
Bell	Warn Sys	ACF	ASE	Alarm	BGD ALM1	BGD ALM2	RST/BZ

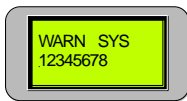

To move through the sub menu use the  Move Right and  Move Left keys. For each output press , then the  Move Left and  Move Right to select the Zones that will operate or not operate that output. Pressing the  Move Up key will set the Zone to activate the output and the  Move Down key will set the selected Zone so it does not activate the output.

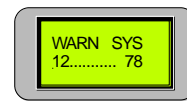

All 8 Zones Selected





Zones 1,2,7 and 8 Selected

Press  to Update the Program then Cancel to return to the Sub Menu and the  Move Right and or  Move Left keys to move through it. Repeat the above procedure to set or change the other Outputs as required.







Set the **Reset / Buzzer output** option so as the output acts as a Reset or Buzzer function as per the system design configuration.



Screen Showing the Output Set to Reset

If the output is used set as a Reset or Buzzer function by using the  Move Up for Buzzer or  Move Down keys for Reset. Press  to update the program









5.3.5 Relays

Press  then use the  Move Right and / or  Move Left keys to select a relay that will be operated by the selected functions in the sub - menu . Press  to access the sub – menu then  Move Right and /or  Move Left keys to toggle through the sub - menu structure. The sub menu consists off;

Zone Alarm	Zone Fault	Zone Isolate	Input	Switch	<i>Reset</i>	<i>ACF Isolate</i>
-------------------	-------------------	---------------------	--------------	---------------	--------------	--------------------

For:

Zone Alarm	Zone Fault	Zone Isolate	Input	Switch
-------------------	-------------------	---------------------	--------------	---------------

Press  then  Move Right and /or  Move Left keys to select the *Zone Alarm / Fault / Isolate, Input or Switch* then  . Use the  Move Right and / or  Move Left keys to select the Zones and the  Move Up or  Move Down keys to set it to be active or in-active.



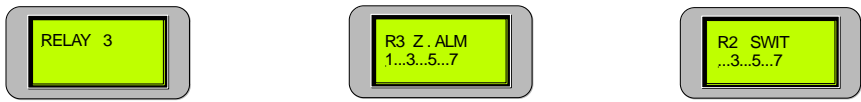

Active meaning the *Zone Alarm / Fault / Isolate, Input or Switch* will operate the Relay where as in–active will prevent them from operating that relay.





Press  to update the Program and the  to back out to the previous menu.

For:

<i>Reset</i>	<i>ACF Isolate</i>
--------------	--------------------

Press  then the  Move Right and /or  Move Left keys to select *Reset or ACF Isolate* then the  Move Up or  Move Down keys to set for *Yes or No*. Yes sets the Relays to be reset or isolated

when the *Reset and / or ACF Isolate* buttons are pressed. Press  to update the Program and  to back out to the previous Menu.

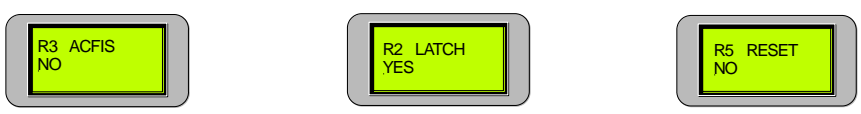

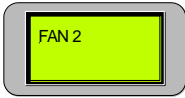

5.3.6 Fire Fan











The sub menu consists of;

Alarm	Inhibit	Function	Latch	ACF Isolate
-------	---------	----------	-------	-------------



For: **Alarm** **Inhibit**

Press  then use the  Move Right and / or  Move Left keys to select the Fire Fan that will be controlled by the selected functions in the sub - menu .

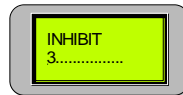
Press  to access the sub – menu then  Move Right and /or  Move Left keys to toggle through the sub - menu structure. Press  then  Move Right and /or  Move Left keys to select the Zone/s that will activate or deactivate the control when it is in alarm or inhibited. Use the  Move Up or  Move Down keys to set it to active or in-active. Active meaning the Zone will operate the control where as in–active will prevent that Zone from having control.





For: **Function**

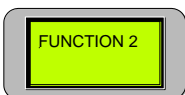

Press  and the cursor will flash over the number 0,1 or 2, then press the  Move Up or  Move Down keys to select the required Function. Selection relies on how the inputs / outputs have been physically wired from the Fan Termination Board as outlined below.

- 0:** equates to a 3 wire Start / Stop, Run & Common.
- 1:** equates to a 4 wire Start / Stop, Run, Stop & Common.
- 2:** equates to a 5 wire Start / Stop, Run, Stop, Fault & Common.



Press  to update the Program and then  to back out of the Menu.



For: **Latch** **ACF Isolate**

Press  and the cursor will flash over YES or NO and then the  Move Up key for Yes to set the card to be latching or  Move Down key for No to set the card for non-latching on alarm.



Press  to update the Program and  to back out of the Menu.

ACF Isolate

Press  and the cursor will flash over YES or NO and then the  Move Up or  Move Down keys to set the card to be isolated or not isolated by the ACF key, that is Yes or No.

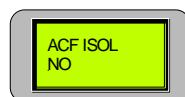
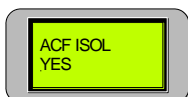







Press  to update the Program and **Cancel** to back out of the Menu.

5.3.7 Agent

If Yes was selected in the SYSTEM menu the Sub – Menu seen below will be available. Press **Enter** to access the sub-menu. The sub-menu consists off;

Release	Press Sw	Auto Delay	Man Delay	No LCP's	LCS Buzzer
Solenoid Pyrogen Metron	NO/NC/None N/O & Mech	0 – 60s	0 – 60s	0 - 16	Normal / Silent

Using  Move Right or  Move Left select either **Release, Sense Switch, Auto Delay, Manual Delay** or the **Number of Local Control Panels (LCP's)**, and / or **Inhibit LCS Buzzer** then the  key to access the menu and the  Move Up or  Move Down keys to set the required function or number.

In the **Delay** Menus the  Move Up and  Move Down keys are used to set or alter the time delay in 5 second increments.

Press  to update each Program and **Cancel** to back out of the Menu.

Release

Identifies the type of release mechanism. [Constant / Solenoid / Pyrogen / Metron].

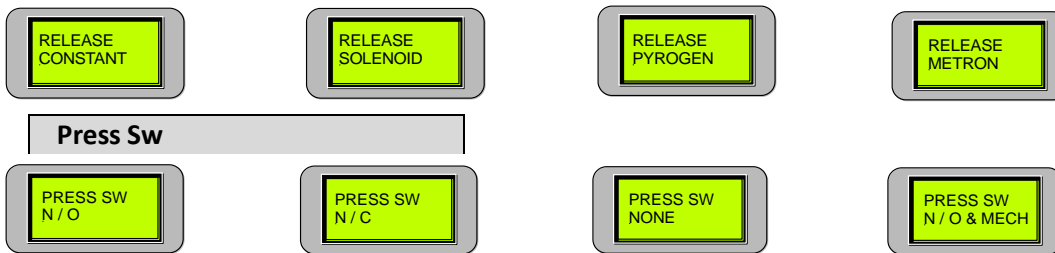

Sets the type of monitor release contact. [NO / NC / None N/O & Mech – manual release]

Auto Delay



Sets the delay for the automatic release of the agent. [0 – 60 seconds set in 5 second increments]

Man Delay





Sets the delay for when the agent is released manually. [0 – 60 seconds set in 5 second increments]

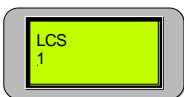

No LCS's



Tells the FACP how many Local Control Panels are in service. [0 – 4]



5.3.8 Sounders

Press  then use the  Move Right and  Move Left keys to select a sounder.

Press  again and use the  Move Right and  Move Left keys to select a Sounder,

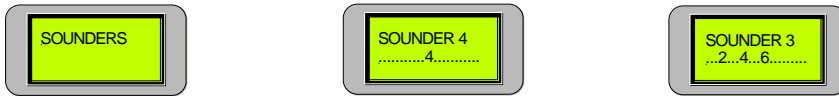
Press  again and the  Move Up and  Move down keys to set that Sounder to a Zone to activate or not activate the selected sounder.





Press  to update each Program and  to back out of the Menu.

5.3.9 Indicate

If a General Indicator Card is selected via the System Menu then all the tri-coloured LED's default to red. To alter the colour of the LED select Indicate then press . The LCD will display "Style 1"



Use the  Move Up and the  Move Down keys to scroll through the different styles.

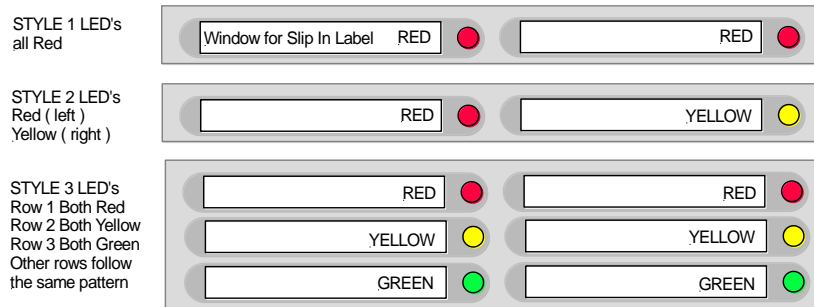

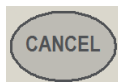





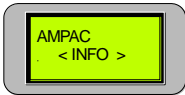



Figure 14: Examples of the different "Styles" available through the Indicate Menu are shown above. Note only the top display is shown in the first 2 examples where as the first 3 top displays are shown in Style 3

Once the "Style has been selected press  to update the Program and  to back out of the Menu.









5.3.10 Display

To set the message, FACP or company name press  and use the  Move Right and  Move Left keys to move through the word to select a letter and the  Move Up and the  Move Down keys to move through the alphabet. A maximum of 16 characters are available for this message.





Press  to update each Program and  to back out of the Menu.

5.3.11 Zone Labels

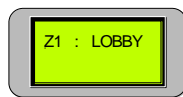
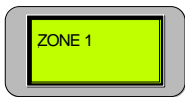
To name the Zones press  then the  Move Right and / or the  Move Left keys to select a Zone. Press  and use the  Move left and / or  Move Right keys to move the cursor through the structure of the word and the  Move Up and  Move Down keys to move through the alphabet.



Press  to update each Program and  to back out of the Menu.

5.3.12 End Of Line (EOL)

Press  and use the  Move Up and  Move Down keys to select the EOL option. The options are CAP 10µf, RES 3K3 (AS factory default value), 4K7, 6K8 and 10K.

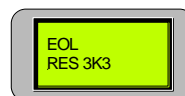
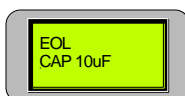

Press **Enter** to update each Program and **Cancel** to back out of the Menu.

5.3.13 Zone S/C

Press  and use the  Move Up or  Move Down key to set the panel to initiate either an Alarm or Fault when a Zone short circuited condition exists.

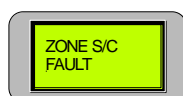
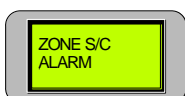

Press **Enter** to update each Program and **Cancel** to back out of the Menu.

6 Agent Release

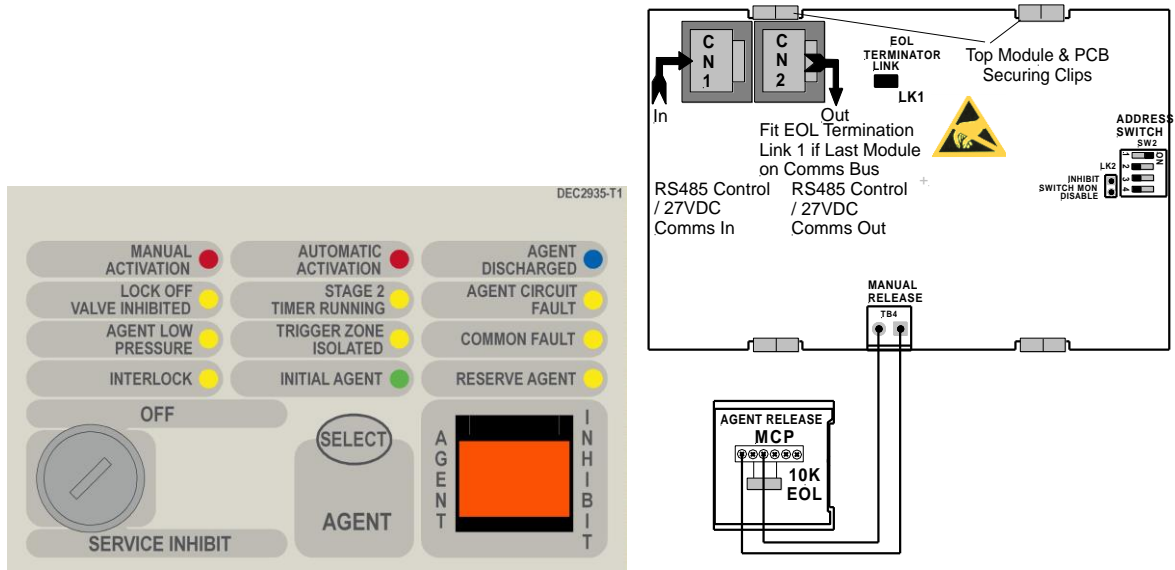

Figure 15: AS4428 Agent Control Card

6.1 Controls



It is a requirement that control be secured from unauthorised use. A keyswitch has therefore been included in the control process.

The FCP goes into service mode when the keyswitch is switched to SERVICE INHIBIT. This results in the selected agent activation circuit being electrically isolated and a Common Isolate condition being indicated at the FACP. This condition can also be confirmed through the Status Menu. To remove the key it is necessary for the switch to be in the **OFF** position.



Pressing Select toggles the selection of either the Main or Reserve release agent. Selection is indicated by the Main and Reserve Agent LED's



Pressing the Agent Inhibit switch will inhibit the gas from release in either the Manual or Automatic mode. The Agent Inhibit switch has an internal lamp fitted with yellow lens and is illuminated when the Inhibit switch is activated at the FACP or any of the LCS's. To prevent accidental operation this switch has a hinged clear plastic cover that has to be raised to access the switch.

Manual Release

The ARC has provision to connect a front panel MCP. When the MCP is activated – a manual release sequence of the agent is started.

The MCP is fitted with a protective flap – hence two actions are required to release the agent – that is lift the flap and activate the MCP.

6.2 LocalControl Station

The Local Control Station is supplied fitted into an IP40 rated enclosure and has the same indicators and Manual Release switch as the Agent Release Module within the Fire Alarm Control Panel (FACP) but no Agent Select button or Service Inhibit keyswitch.

The Comms line is RS485 and is cabled to the Agent Termination Board.

The Interlock is a monitored input with 10K Ω EOL. This input is used to determine if air conditioning dampers and doors are closed but can be defaulted to the "ON" condition by terminating the input with a 2K Ω EOL.

Double action switching is achieved by way of protective lift up covers seen here and manual operation of the MCP or Inhibit switch.

To ensure correct operation and prevent accidental release of the agent these covers **should not** be disabled for any reason.



Figure 16: Local Control Station

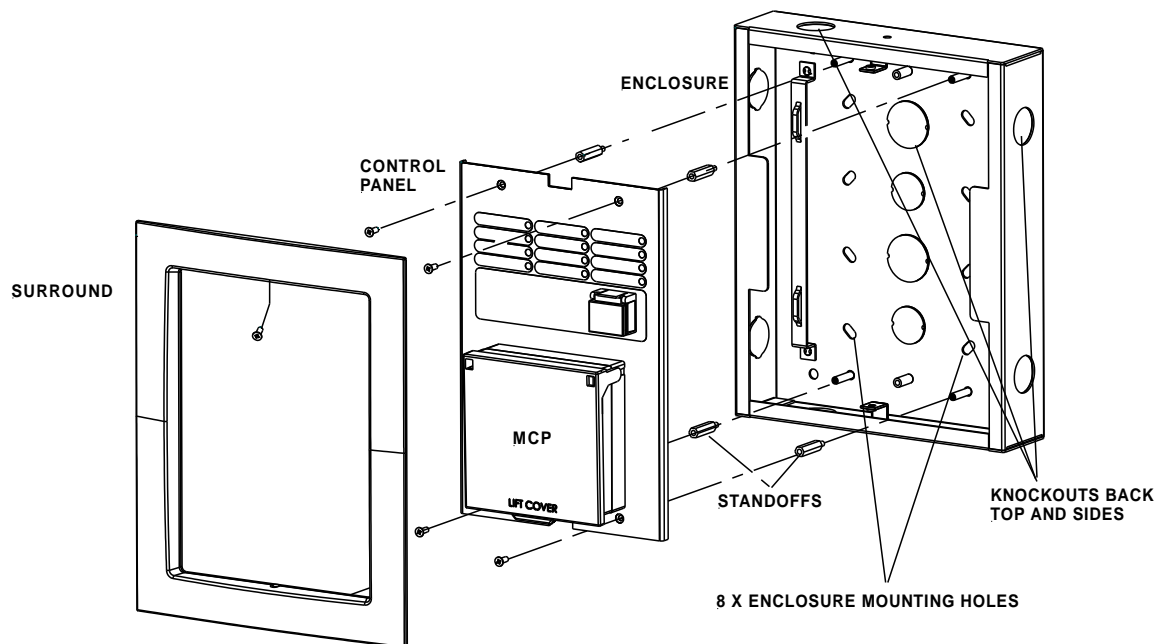



Figure 17: Local Control Station Layout

LCS Operation & Controls

Lifting the cover and pressing the MCP starts the manual agent release sequence. This two action safety feature prevents any accidental operation of the control and should not be disabled.

6.3 Common Agent Release Card & LCS Indicators

There are 12 indicators on both the Agent Release Module and Local Control Station. They are;

 **(Red)** Illuminated when a manual release sequence has commenced. A Manual release sequence can only be started by activating the manual release at the FACP or LCS.

The indicator is extinguished by activating RESET on the FACP.

 **(Red)** Illuminated when a manual release sequence has commenced. This occurs when the selected zone(s) on the FACP have gone into alarm. For dual zones, the indicator should flash when the first zone goes into alarm, and steady when the second zone goes into alarm.

Indicator is extinguished by activating RESET on the FACP.

 **(Blue)** Illuminated when the pressure switch indicates the agent has been released. For Pyrogen, feedback is from the thermal switch. If there is no pressure switch fitted, the indicator shall be illuminated immediately the agent release signal is activated (Selected via FACP on-site programming – refer to relevant FACP Manual)

The indicator is extinguished by activating RESET on the FACP.

 **(Yellow)** Illuminated when the lock-off valve has been activated.

 **(Yellow)** Illuminated when the pre-discharge delay timer is running.

The indicator is extinguished by activating the RESET control on the FACP.

 **(Yellow)** Illuminated when there is a fault on the monitored Main or Reserve activation circuits e.g. S/C or O/C.

 **(Yellow)** Illuminated when the low pressure switch is activated. This indicates a leakage at the agent cylinder. The low pressure switch is a separate switch.

 **(Yellow)** Illuminated when any of the programmed trigger zones on the FACP are isolated.

 **(Yellow)** Illuminated under the following fault conditions;

pressure switch monitoring fault,

low pressure switch monitoring fault,

lock-off valve monitoring fault,

activation circuit fault,

stage 1 output fault,

stage 2 output fault,

LCS fault (missing or extra),
trigger zone(s) fault,
low agent pressure and interlock fault.

INTERLOCK  **(Yellow)** Illuminated when the interlock input (e.g. from dampers, doors etc) is off during the discharge sequence – meaning the dampers, doors etc are not closed as they should be or a fault exists. The “Interlock” is overridden after 10 seconds and the agent is released



Note: The Interlock is a Monitored Input and can be defaulted to the ON position by terminating the input (TB2 7 & 8) into a 2K2Ω resistor.

INITIAL AGENT  **(Yellow)** Illuminated when the “Initial Agent” is selected.

RESERVE AGENT  **(Yellow)** Illuminated when the “Reserve Agent” is selected.

Local Control Panel Inhibit

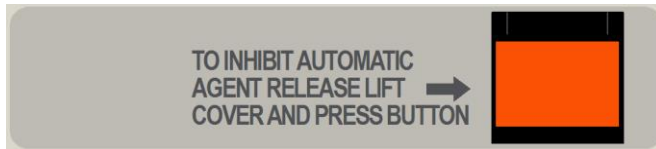

The agent inhibit switch has an internal lamp fitted with yellow lens. Illuminated when the inhibit switch is activated at the FACP or any of the LCS's.

Manual Release

The ACC has provision to connect a MCP. When the MCP is activated – a manual release sequence of the agent is started.

The MCP is fitted with a protective flap – so two actions are required to release the agent – lift the flap and activate the MCP

6.4 Agent Release Operation

The agent release can release the agent via automatic or manual activation. By default the agent release add-on is in a mode where a release occurs automatically or manually (automatic mode).

When the agent inhibit switch is operated at any LCS or the FACP then the agent inhibit indicator shall be illuminated at all LCSs and the ARC, the buzzer sounds at all LCSs and the agent can only be released by a manual activation. This is referred to as the manual mode.

The pressure switch input on the termination board (which is used to confirm that the agent has been released) can be configured to accept a normally open contact, normally closed contact, or ignored. This is selected via FACP on-site programming. In addition the agent release can monitor the pressure switch input and provide notification that the agent has been released by a manual mechanical means.

6.5 Manual Mode

When the module is in manual mode, then the

- Agent Inhibit indicator is illuminated at the ARC and all LCSs
- The buzzer sounds at all LCSs. The buzzer does not sound at the ARC (at the FACP). The buzzers sound until the inhibit condition is released.
- System Inoperative output is turned on
- Automatic release sequences are prevented from starting
- If an automatic release sequence was underway and then the inhibit switch is activated (switched to manual mode), then the release sequence is aborted and the sequence is reset. This means the stage 1 and stage 2 outputs are switched OFF.
- The FACP treats the (isolate of disable) condition according to the applicable fire code (AS7240.2 or AS4428.1). For AS4428, the FACP activate the brigade isolate output, light the isolate indicator and, report the condition to the LCD For AS7240, the FACP activates the isolate relay on the brigade board (if fitted), light the disable indicator and report the condition to the LCD.

To manually release the agent, the manual release at the ARC or a LCS is activated. For a manual release sequence to commence, the lock-off valve and the service inhibit must be in the OFF position. The manual release sequence is;

- Manual Activation indicator is illuminated on the ARC and LCSs, providing the lock-off valve and the service inhibit are in the OFF position
- If the agent add-on has been assigned a zone number, then the brigade and supervisory outputs associated with that zone shall be activated (external alarm (bell), warning system, plant (ACF), ASE, Alarm 1 and Alarm 2)..
- Stage 1 monitored output is switched to +24VDC, and the stage 1 relay is closed
- Stage 2 output is switched to +24VDC, and the stage 2 relay is closed
- Start optional pre-release delay (Selected via FACP on-site programming – refer to relevant FACP Manual) and turn on the stage 2 timer indicator
- Upon expiration of delay, wait till the interlock signal is on, and then activate the selected activation circuit. If the interlock is in fault, then the agent will be released if the interlock signal is not asserted within 10 seconds.

- Light the agent release indicator on the ARC at the FACP and LCSs when the pressure switch input on the termination board is activated or immediately (depends on the pressure switch configuration – refer to FACP on-site programming).
- Activate gas-fired relay output.
- When the FACP reset control is activated – the manual activation indicator, agent discharge indicator, stage 2 timer running are extinguished, and the stage 1, stage 2, selected activation circuit and gas fired output are switched off (to 0VDC).

If the agent select button is operated at the ARC once the agent has been released, then the newly selected activation circuit is operated immediately. The manual release facility will cause the release of the agent unless there is a fault on the activation circuit, the lock-off valve has been operated or the service inhibit control is active.

The interlock input can be defaulted to the ON position by an appropriate termination resistor.

If the lock-off valve or service inhibit is activated to the ON position during the sequence, then the sequence is aborted. This means the manual activation indicators at the ARC and LCSs are extinguished, the Stage 1 and Stage 2 outputs are switched OFF and the FACP Bell, ASE, Warning System, Plant and Alarm outputs are switched OFF. The system inoperative output shall turn on.

If the lock-off valve or the service inhibit is operated after the agent has been released then there is no effect on the stage 1 and stage 2 outputs and the selected activation circuit. The system inoperative output shall be activated.

6.6 Auto Mode

Automatic release is when one or two zones going into alarm initiate the agent release sequence.

For an automatic release sequence to commence the lock-off valve and the service inhibit switch must both be in the OFF position.

6.6.1 Single Zone Activation

With single zone activation, when the zone goes into alarm, then the following release sequence is executed:

- Automatic activation LED is illuminated on the ARC and LCS's
- Stage 1 output is switched to +24VDC, and the stage 1 relay output is closed
- Stage 2 output is switched to +24VDC, and the stage 2 relay output is closed
- Start optional pre-release delay (Selected via FACP on-site programming – refer to relevant FACP Manual) and turn on the stage 2 timer indicator.
- Upon expiration of delay, wait till the interlock signal is on, and then activate the selected activation circuit. If the interlock is in fault, then the agent will be released if the interlock signal is not asserted within 10 seconds.
- Illuminate the agent release LED on the ARC and LCS's when the pressure switch input on the termination card is activated or immediately (depends on the pressure switch configuration – refer to FACP on-site programming).
- Activate gas-fired relay output.

- If the agent add-on has been assigned a zone number, then the brigade and supervisory outputs associated with that zone shall be activated (external alarm (bell), warning system, plant (ACF), ASE, Alarm 1 and Alarm 2).
- When the FACP reset control is activated – the automatic activation indicator, agent discharge indicator, stage 2 timer running are extinguished, and the stage 1, stage 2, selected activation circuit and gas fired output are switched off (to 0VDC).

If the agent select button is operated at the ARC once the agent has been released, then the newly selected activation circuit is operated immediately.

The interlock input can be defaulted to the ON position by an appropriate termination resistor.

If the lock-off valve or service inhibit is activated to the ON position during the sequence, then the sequence is aborted. This means the automatic activation indicators at the ARC and LCSs are extinguished and the Stage 1 and Stage 2 outputs are switched OFF. The system inoperative output shall be activated.

If the trigger zone is isolated during the sequence, then the sequence is aborted. This means the automatic activation indicators at the ARC and LCSs are extinguished and the Stage 1 and Stage 2 outputs are switched OFF. The system inoperative output shall be activated. The trigger zone isolated indicator shall be illuminated.

If the lock-off valve or service inhibit switch is operated after the agent has been released then there is no effect on the stage 1 and stage 2 outputs and the selected activation circuit. The system inoperative output shall be activated

If the trigger zone is isolated after the agent has been released, then there is no effect on the stage 1 and stage 2 outputs and the selected activation circuit. The system inoperative output shall be activated. The trigger zone isolated indicator shall be illuminated.

6.6.2 Dual Zone Activation

With dual zone activation, when the first zone goes into alarm the following steps occur;

- The automatic activation LED at the ARC and LCSs flashes
- Stage 1 output is switch to –24VDC, and the stage 1 relay output is closed

When the second zone goes into alarm, then the following steps occur;

- Automatic activation LED goes steady
- Stage 1 output is switched to +24VDC
- Stage 2 output is switched to +24VDC, and stage 2 relay output is closed
- Optional pre-release delay commences (Selected via FACP on-site programming – refer to relevant FACP Manual).
- Upon expiration of a delay the interlock signal is on and then activate the selected circuit. If the interlock is in fault, then the agent will be released if the interlock signal is not asserted within 10 seconds.
- The agent release LED on the ARC and LCSs is illuminated when the pressure switch input on the termination card is activated or immediately (depends on the pressure switch configuration – refer to FACP on-site programming).
- The gas-fired relay output is then activated.

- If the agent add-on has been assigned a zone number, then the brigade and supervisory outputs associated with that zone shall be activated (external alarm (bell), warning system, plant (ACF), ASE, Alarm 1 and Alarm 2).

If the agent select button is operated at the ARC once the agent has been released, then the newly selected activation circuit is operated immediately.

The interlock input can be defaulted to the ON position by an appropriate termination resistor.

If one of the two trigger zones is isolated during the sequence, then the Stage 2 outputs are switched OFF, the Stage 1 switch positive output is switched to -24VDC and the automatic activation indicator commences to flash.

If both of the two trigger zones are isolated during the sequence, then the Stage 1 and Stage 2 outputs are switched OFF, and the selected activation circuit is switched OFF. The system inoperative output is activated and the trigger zone isolated indicator is illuminated.

If the lock-off valve or service inhibit switch is activated to the ON position during the sequence, then the sequence is aborted. This means the automatic activation indicators at the ARC and LCSs are extinguished and the Stage 1 and Stage 2 outputs are switched OFF. The system inoperative output shall be activated.

If one or both of the two trigger zones are isolated after the agent has been released, then there is no effect on the stage 1 and stage 2 outputs and the selected activation circuit. The system inoperative output shall be activated. The trigger zone isolated indicator shall be illuminated.

If the lock-off valve or service inhibit switch is operated after the agent has been released then there is no effect on the stage 1 and stage 2 outputs and the selected activation circuit and the system inoperative output is activated

6.6.3 Manual Activation

It shall be possible to instigate a manual release whilst the module is in the auto mode.

A manual release is initiated by operating the manual release control at the ARC or the LCS.

If an automatic release sequence has not started, then the manual release sequence proceeds as detailed in previously. Note that the LCS inhibit control WILL NOT abort the manual release sequence.

If an automatic release sequence has started, then the manual release will interrupt the automatic release and take over the remainder of the sequence. The following tables outline the operation.

Single Zone Activation

Current Step in Activation Sequence	Manual Activation
1, 2, 3	Extinguish automatic activation LED and commence manual activation steps 1 thru 8
4, 5	Extinguish automatic activation LED, light the manual activation LED, instigate 5 second delay, resume at step 6
6,7	No effect

Dual Zone Activation

Current Step in Activation Sequence	Manual Activation
1, 2, 3, 4, 5	Extinguish automatic activation LED and commence manual activation steps 1 thru 8
6,7	Extinguish automatic activation LED, light the manual activation LED, instigate 5 second delay, resume at step 6
8,9	No effect

6.7 Service Switch

This optional input is used to bring a fault into the system from an external source. Requirements for the input are an open collector or 0 volt, voltage free contact to initiate a fault. Connection is to TB3 COM & 3

6.8 Lock-Off Valve

The service switch is situated at the ARC, and when activated causes the following

- Electrically isolates the activation circuitry from the agent release device
- Operates the System Inoperative output.
- The service switch is not overridden
- Activates an isolate condition at the FACP, For AS4428, the FACP activates the brigade isolate output, illuminates the isolate indicator and, reports the condition to the LCD. For AS7240, the FACP activates the isolate relay on the brigade board (if fitted), illuminates the disable indicator and reports the condition to the LCD and the buzzer shall sound after 8 hours.

A manual or automatic release sequence is prevented from starting if the service switch has been operated prior to the sequence commencing, and the sequence is aborted if the service switch is operated during the sequence.

If the agent release module is in the manual mode, then the service switch is activated, and then the service switch is de-activated, the agent release module will default to the automatic mode.

6.9 Fault Supervision

- The sources of fault in the system are:
- Pressure switch
- Low pressure switch
- Lock-off valve
- Selected activation circuit
- Stage 1 outputs
- Stage 2 outputs
- Fault in the trigger zones
- Fault on the interlock input
- Fault with a LCS
- Low agent pressure

With all faults the common fault indicator at the Front Panel and LCSs is illuminated.

For a pressure switch fault, low pressure switch fault, lock-off valve fault, stage 1 output fault and stage 2 output fault, trigger zones, LCS fault(missing), interlock fault the FACP will signal the brigade accordingly.

With a fault in the activation circuit, interlock circuit or fault with the trigger zones, in addition to the above, the system inoperative output is operated.

The FACP fault buzzer will sound for all faults.

The FACP will report the type of fault on the LCD

6.10 Isolation

If the trigger zones are isolated by the FACP, then the trigger zone isolated indicator at the ARC and LCSs is illuminated, and the system inoperative output is operated.

In addition the brigade isolate relay is operated.

Regarding interfacing the agent release add-on to an addressable FACP, and isolating devices instead of zones:

- The zone is not isolated, until all devices within the zone have been isolate.
- The trigger zone isolated and system inoperative output are only activated when the entire zone is isolated
- If the agent release add-on has commenced to a release sequence, and the device(s) is alarm is (are) isolated, then the release sequence is stopped, since the alarm has been removed. See sections 5.3.1 and 5.3.2. Note the variations for single and dual zone activation

6.11 System Inoperative Output

The system inoperative output is switched to +24VDC under the following conditions:

- Operation of the service switch
- Fault in the selected activation circuit
- Operation of the lock-off valve
- Operation of the inhibit at a LCS
- Fault in any of the trigger zones
- If any of the trigger zones are isolated
- Fault on the interlock.

6.12 Manual Mechanical Release of the Agent

With agent release systems, a manual mechanical means can be provided to release the agent.

If the pressure switch is activated (indicating that the agent has been released), and the agent release add-on has not activated the selected activation circuit, then the following will occur:

- Stage 1 output is switched to +24VDC and stage 1 relay is closed
- Stage 2 output is switched to +24VDC and stage 2 relay output is closed
- Light the agent release LED on the ARC and LCSs
- The FACP activates its Bell, ASE, Warning System, Plant, and Alarm outputs
- Activate gas-fired relay output

6.13 Monitoring of the Pressure Switch

Due to the requirements of 5.9 Manual Mechanical Release of the Agent, the pressure switch input conveys two pieces of information:

- When the pressure switch input is active, it signals that the agent has been released. The release can be as a result of the agent release add-on or due to a manual mechanical release.
- When the pressure switch is not active, it signals that there is a full bottle of agent available to be discharged.

In order for the agent release module to respond to a manual mechanical release, the pressure switch must have been previously not active, to signify that a full bottle of agent is available

7 Warning Device

Description

The warning signs are driven by a 2 wire system and may be configured for single or dual stage operation.

An on-board buzzer provides an audible warning which may be disabled by removing JP4.

External evacuation devices, e.g. sounders may be connected to TB4 of the input termination board. An external mute push-button (N/O contacts) may also be connected to Term 6 on the warning sign PCB to enable the user to silence the internal buzzer and evacuation device. Inserting JP5 disables this function.

Enclosures

The **IP50** is a metal enclosure. The fascia surround is fitted by removing the screw on the left hand side of the enclosure and pulling it away to the left. The fascia sign is fitted in place and the tabs bent over to hold it in place. Two holes in the backpan of the chassis allow for mounting.

The **IP65** ABS enclosure has 10 screws, tightened evenly but not over tightened, hold the fascia in place. Do not over tighten. 4 holes in the backpan allow for mounting.

Specifications:

Operational Voltage	27VDC
Power Consumption Continuous	At 24VDC 55mA Stage 1 At 24VDC 140mA Stage 2 (100mA Muted)
IP Ratings	IP50 190mm (H) x 315mm (W) x 73mm (D) IP65 200mm (H) x 295mm (W) x 65mm (D)
Environmental	-10°C to +55°C Dry heat +40°C @ 0 to 93% Relative Humidity

Installation

Remove the backpan from the enclosure to ensure it is not damaged while mounting the enclosure.

Bring the cabling into the enclosure by removing the knockouts most appropriate for the installation.

Mount the enclosure, remount the back pan, set the configuration and then cable as per the following diagram.

ENSURE THE AGENT IS ISOLATED and test from the Agent Release Module.

Cabling

Term 6 (Buzzer Mute)

BUZZER MUTE Normally Open (N/O) Push Button Switch (Optional)

INPUT

Term 2 (Single pair polarity reversing / 2 Stage Input)	
Stage 1	0V – 24VDC
Stage 2	24VDC – 0V

Configuration – Jumper Settings

Jumper No.	Description		
JP-1 1 2 3 JUMPER NUMBERING	1 – 2	Dual Level	Top row LED's will be ON at Level 1 Alarm All LED's will be ON at Level 2 Alarm
	2 - 3	Single Level	All LED's will be ON at both Level 1 and 2 Alarm
JP-2 1 2 3 JUMPER NUMBERING	1 - 2	Continuous	LED's permanently ON Internal Buzzer outputs continuous tone
	2 - 3	Flashing	LED's flash at approximate rate of 2.3Hz Internal Buzzer outputs tone matching the flashing LED's
JP-3 1 2 JUMPER NUMBERING	1 - 2	Enable Sounder	External Sounder will active at both Level 1 and 2 Alarm
JP-4 1 2 JUMPER NUMBERING	1 - 2	Enable Buzzer	Internal Buzzer will active at both Level 1 and 2 Alarm
JP-5 1 2 JUMPER NUMBERING	1 - 2	Disable Mute	EXT- Disable External Mute for both Internal Buzzer and External Sounder

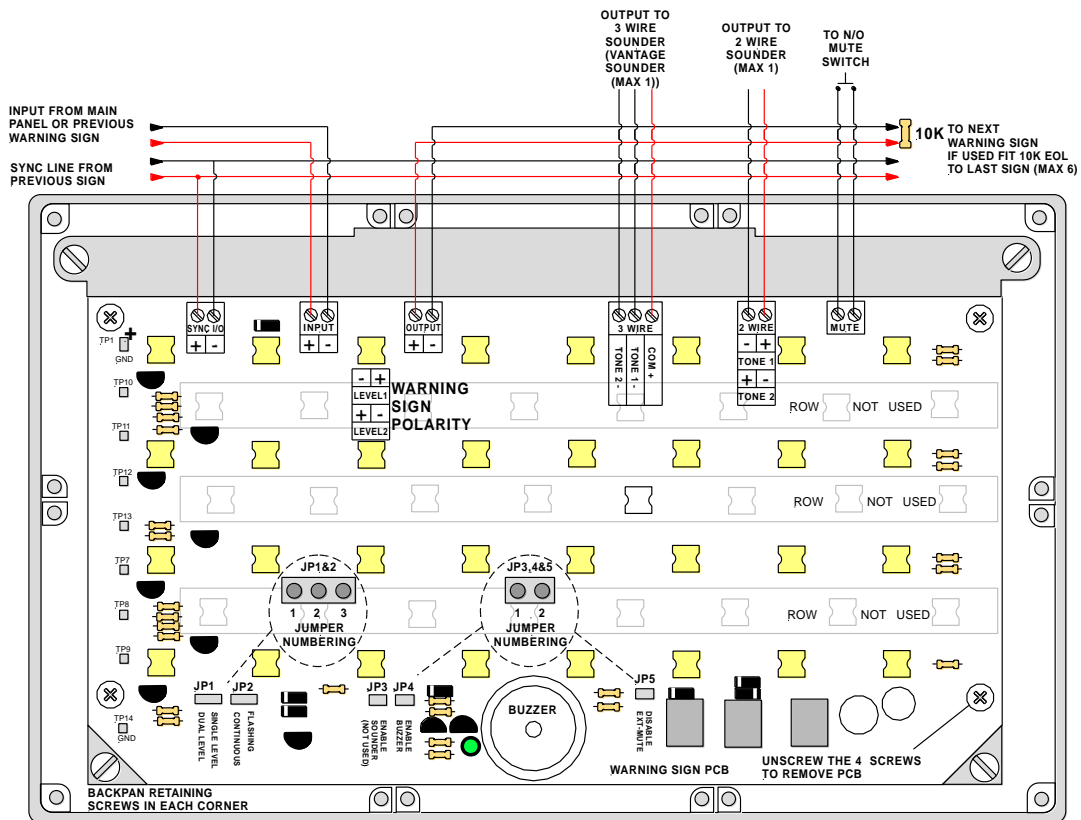

Figure 18: Warning Sign PCB Layout and Cabling

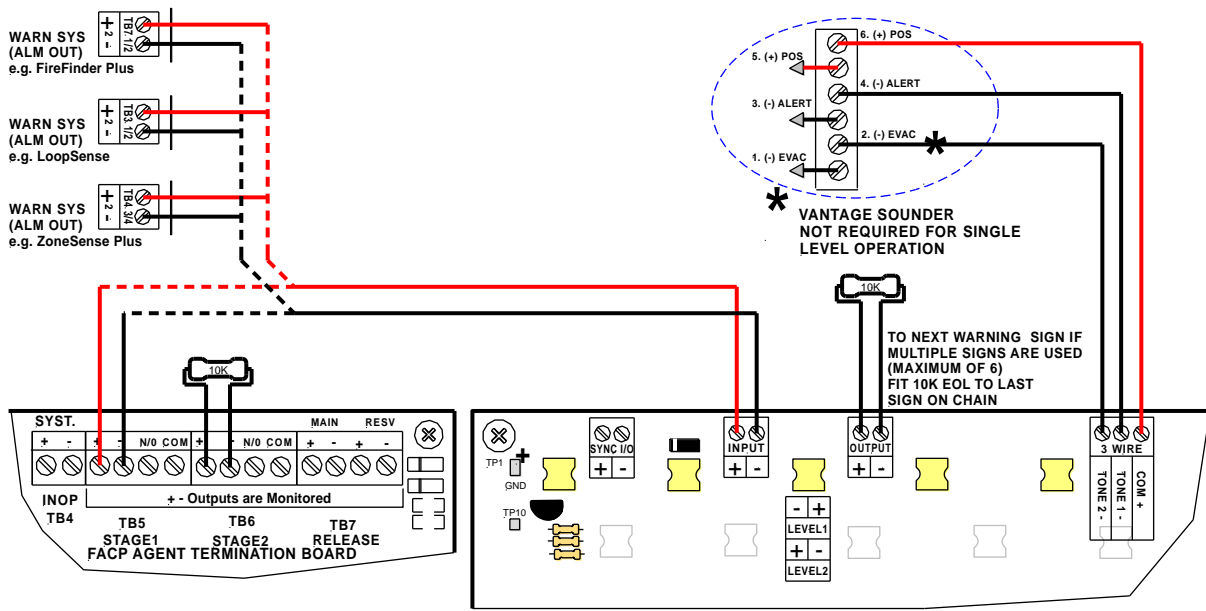
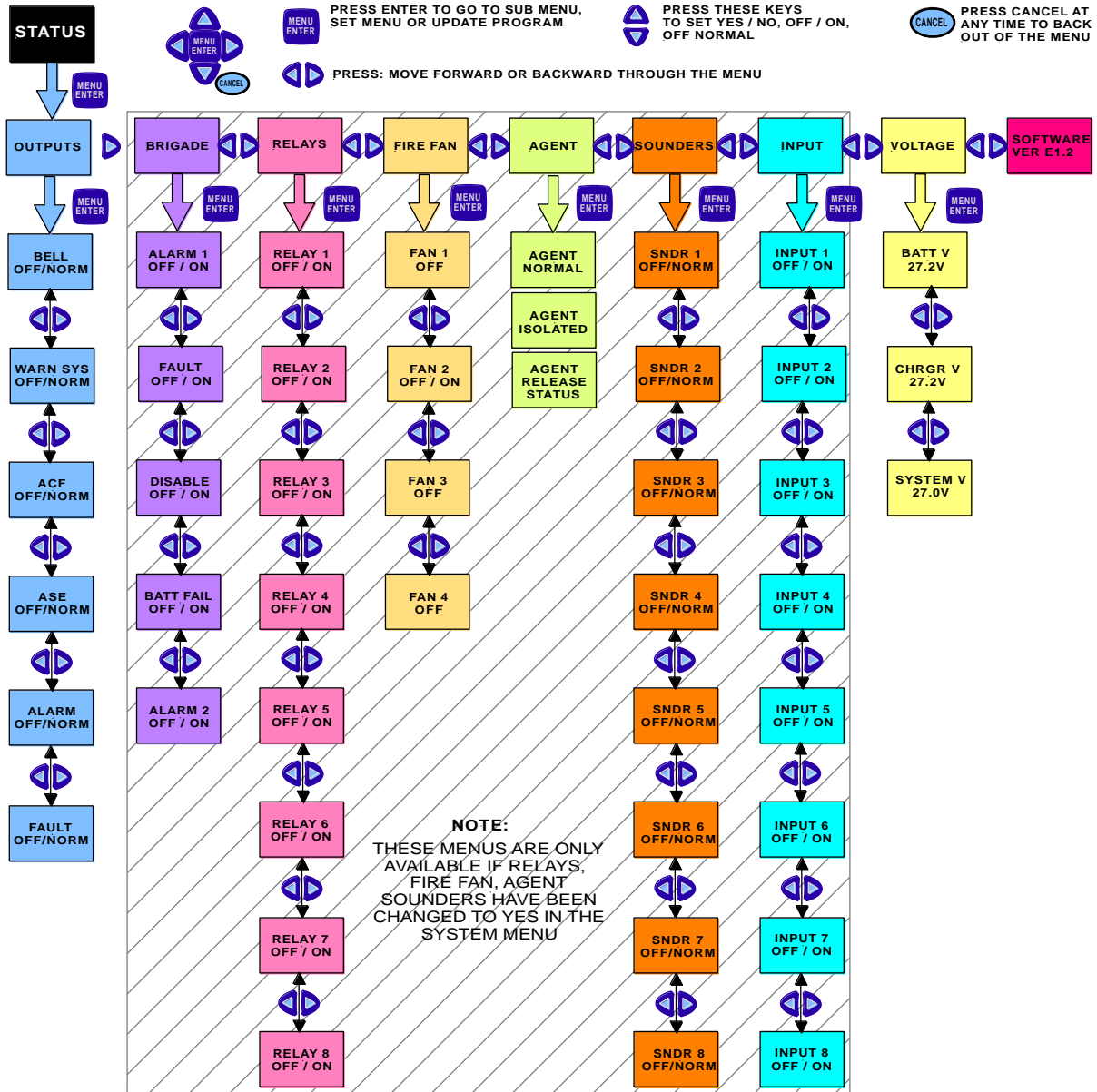

Figure 19: 2 Wire Cabling from the Agent Termination Board to the Warning Sign/s & Evacuation Device/s

8 Appendix A: AS4428 Menu Structure & Programming

STATUS	FAULTS	TESTS	ISOLATE	SYSTEM	PROGRAM
--------	--------	-------	---------	--------	---------

Status



Faults

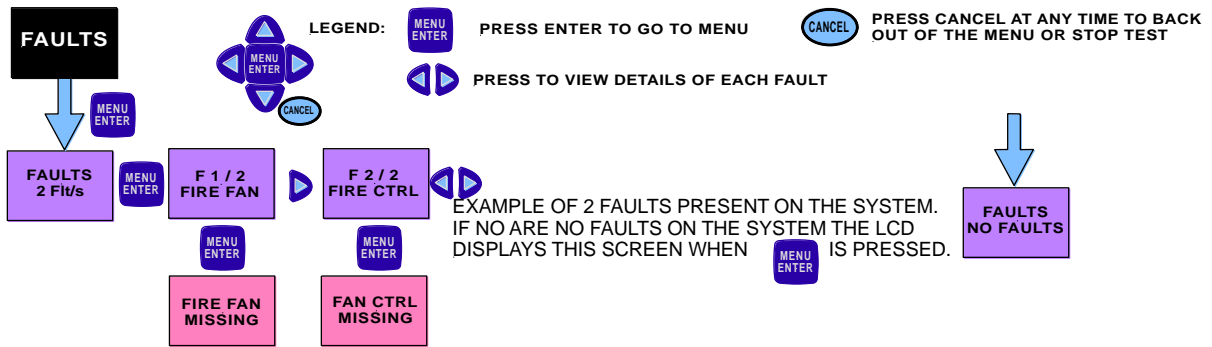

Test

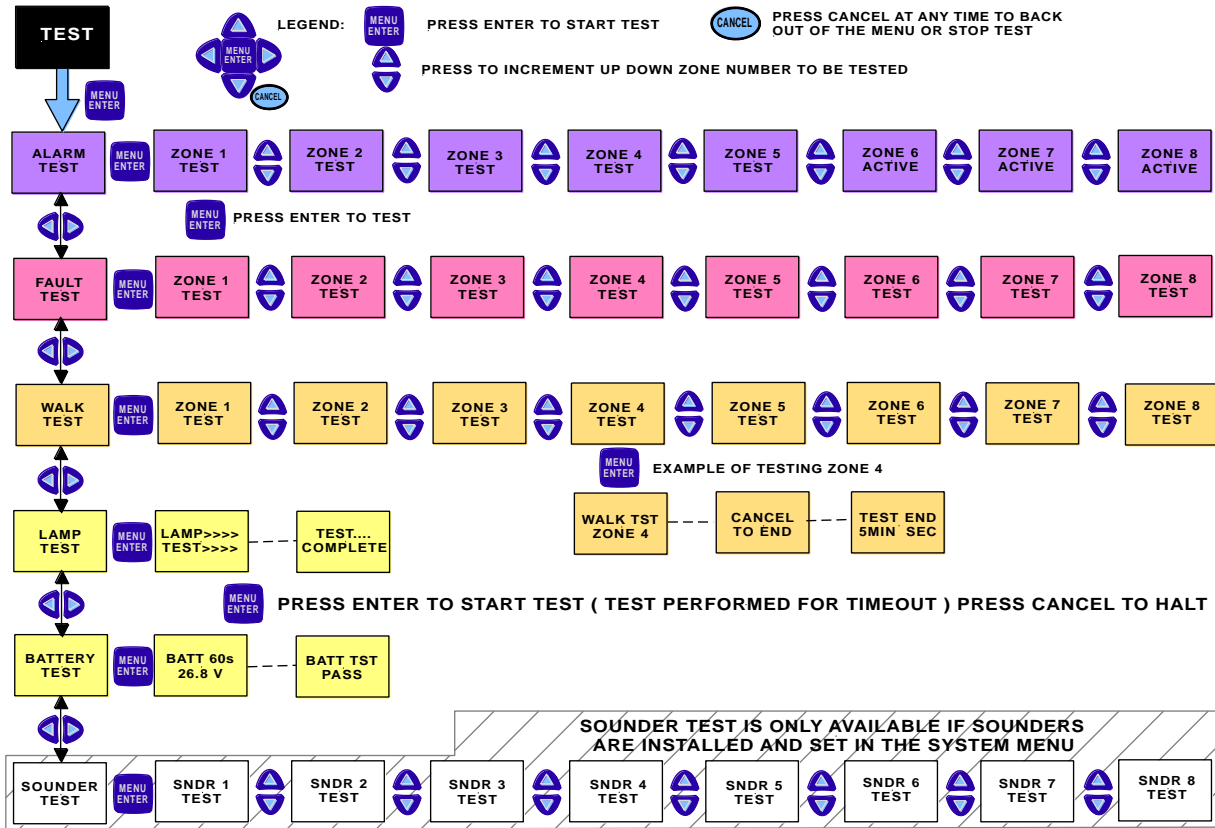

Isolate

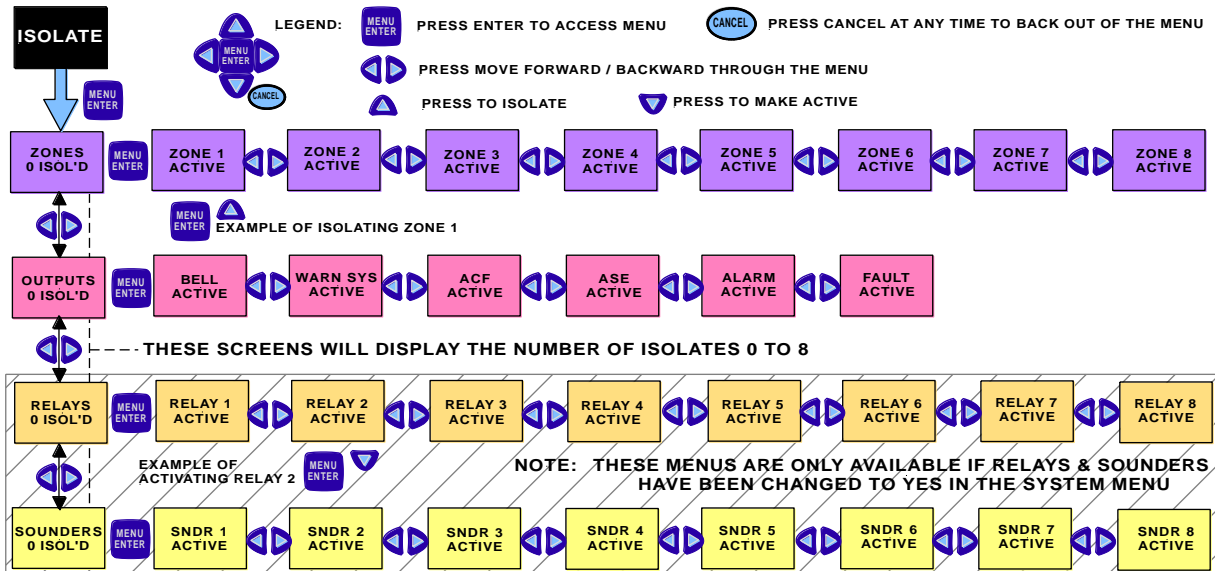

Note: Agent Release can be isolated at the Agent Release Card or by isolating the Agent Trigger (T1 T2) Zones in the Program, Zones Menu.

System (Password required)

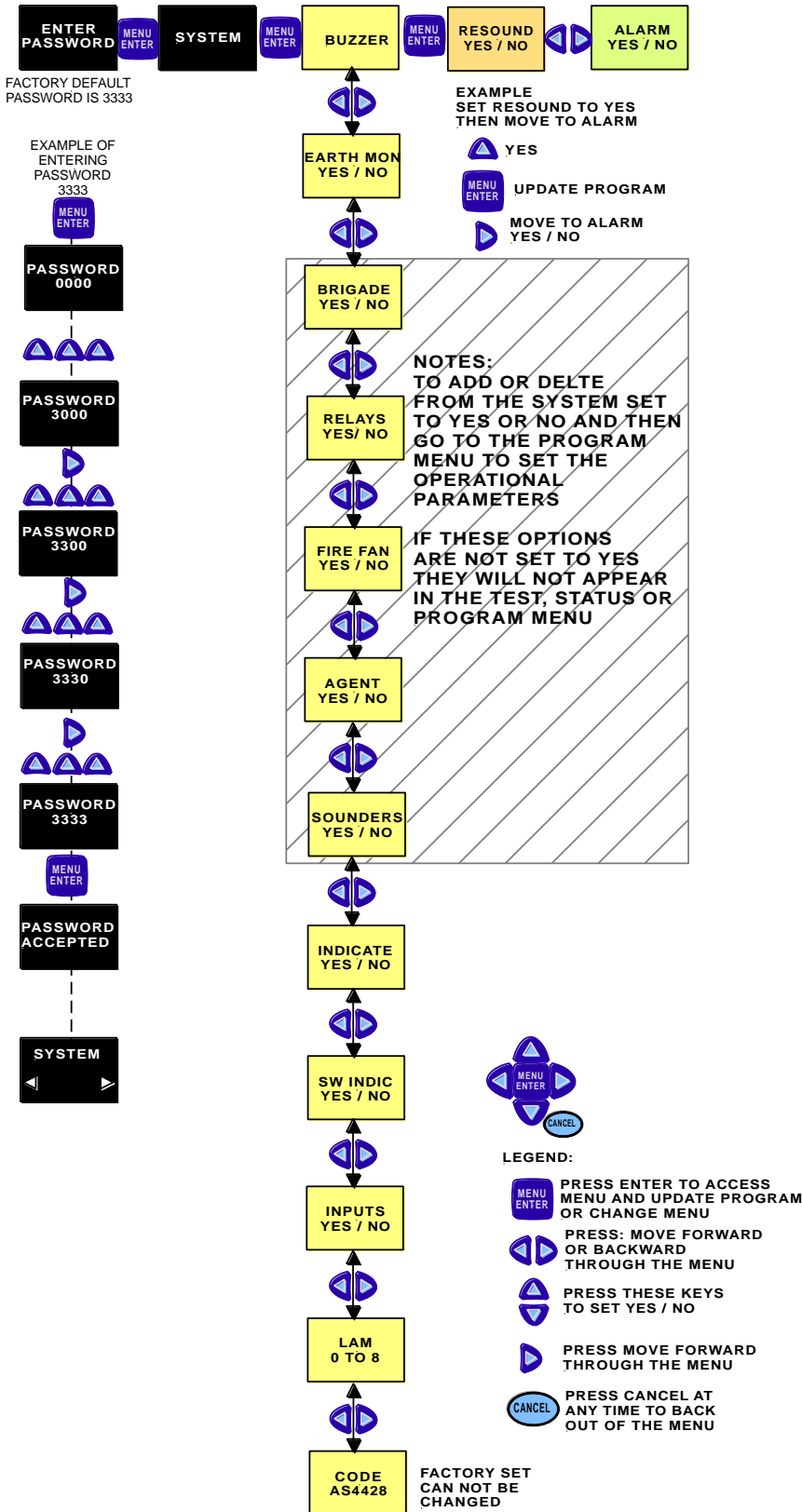

Program

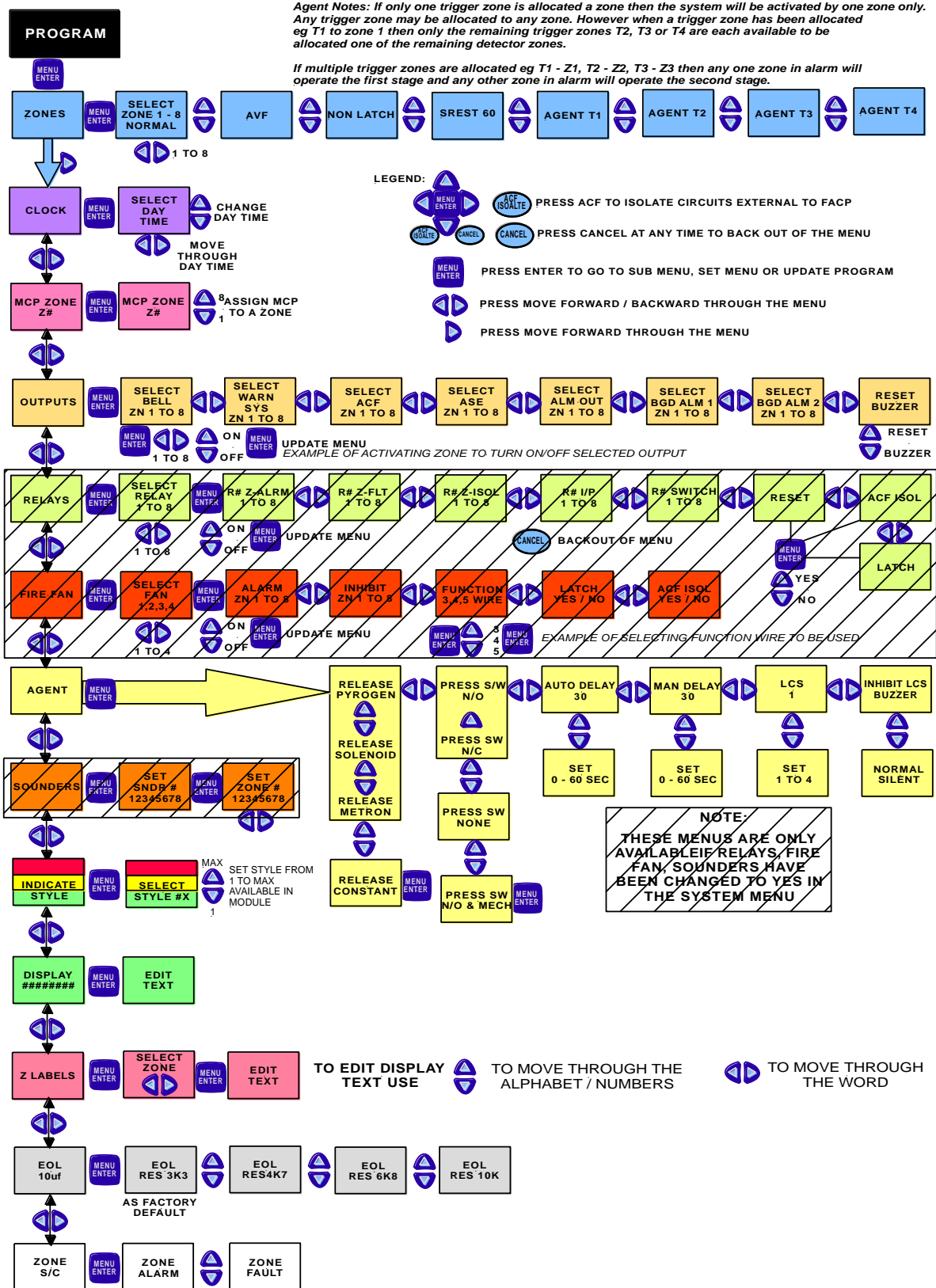

9 Trouble Shooting Chart

Problem	Solution
No Mains Power	Check mains Fuse
Supply fault LED illuminated	Check output voltage it should be set to 27.2VDC. Low = (less than 26.5VDC) High = (greater than 28VDC) Check the battery has been connected properly
Earth Fault LED illuminated	Check all input and output cabling and wiring assemblies for short to ground
System Fault LED illuminated	Ensure correct panel configuration Check all connections for loose wiring
Warning System Fault LED illuminated	Check correct E.O.L is fitted Check wiring is connected correctly
RS485 Communication Bus not working	Refer LCD. This may identify where there is a break in the communication line
Can not access a menu	Incorrect Password entered
Forgotten Password	Ring AMPAC and directions will be given to provide you with a temporary code
Bell / Sounder Fault	Make sure you have a 10K Ω EOL resistor fitted and a diode (1N4004) in series with the bell / sounder

10 Certification Information

The **ZoneSense PLUS - AR** is designed and manufactured by:

AMPAC TECHNOLOGIES PTY LTD

7 Ledger Rd

Balcatta

WA 6021

Western Australia

PH: 61-8-9201 6100

FAX: 61-8-9201 6101



Manufactured to:

Certificate of Compliance Number:

Equipment Serial Number:

Date of Manufacture:

11 Glossary of Terms

ACF:	ANCILLARY CONTROL FACILITY
ACKD:	ACKNOWLEDGED
AHU:	AIR HANDLING UNIT
ALM:	ALARM
AVF:	ALARM VERIFICATION FACILITY
AZF:	ALARM ZONE FACILITY
AZC:	ALARM ZONE CIRCUIT
C:	RELAY COMMON CONTACT (WIPER)
CIC:	CONTROLLER INTERFACE CARD
CN:	CONNECTOR
CPU:	COMMON PROCESSOR UNIT
DGP:	DATA GATHERING POINT
EARTH:	BUILDING EARTH
EOL:	END OF LINE
FDS:	FIRE DETECTION SYSTEM
FACP:	FIRE ALARM CONTROL PANEL
FLT:	FAULT
GND:	GROUND (0 VOLTS) NOT EARTH
I/O:	INPUT/OUTPUT
LCD:	LIQUID CRYSTAL DISPLAY
MAF:	MASTER ALARM FACILITY
MCP:	MANUAL CALL POINT
MOV:	METAL OXIDE VARISTOR (TRANSIENT PROTECTION)
NIC:	NETWORK INTERFACE CARD
N/C:	NORMALLY CLOSED RELAY CONTACTS
N/O:	NORMALLY OPEN RELAY CONTACTS
N/W:	NETWORK
PCB:	PRINTED CIRCUIT BOARDS
P/S:	POWER SUPPLY
PSM:	POWER SUPPLY MODULE
REM:	REMOTE
SPOT:	SINGLE PERSON OPERATING TEST
TB:	TERMINAL BLOCK
VDC:	DIRECT CURRENT VOLTS

12 Definitions

Addressable system - a fire alarm and detection system that contains addressable alarm zone facilities or addressable control devices.

Alarm Verification Facility (AVF) - that part of the FACP, which provides an automatic resetting function for spurious alarm signals so that they will not inadvertently initiate Master Alarm Facility (MAF), or ACF functions. Using ConfigManager prior to downloading to the *FireFinder*[™] sets this option

Alarm zone - the specific portion of a building or complex identified by a particular alarm zone facility.

Alarm Zone Circuit (AZC) - the link or path that carries signals from an actuating device(s) to an alarm zone facility(s).

Alarm Zone Facility (AZF) - that part of the control and indicating equipment that registers and indicates signals (alarm and fault) received from its alarm zone circuit. It also transmits appropriate signals to other control and indicating facilities.

Alert signal - an audible signal or combination of audible and visible signals, from the occupant warning system to alert wardens and other nominated personnel as necessary to commence prescribed actions.

Ancillary Control Facility (ACF) - that portion of the control and indicating equipment that on receipt of a signal initiates predetermined actions in external ancillary devices.

Ancillary equipment - remote equipment connected to FACP.

Ancillary relay - relay within FACP to operate ancillary equipment.

Ancillary output - output for driving ancillary equipment.

Approved and approval - approved by, or the approval of, the Regulatory Authority concerned.

Card-detect link - a link on a module connector to indicate the disconnection of the module.

Conventional System - is a fire detection system using a dedicated circuit for each alarm zone.

Distributed system - a fire alarm and detection system where sections of the control and indicating equipment are remotely located from the FACP or where sub-indicator panel(s) communicate with a main FACP.

Field connections - are connections made to FACP or ancillary equipment during installation.

Fire alarm system - an arrangement of components and apparatus for giving an audible, visible, or other perceptible alarm of fire, and which may also initiate other action.

Fire detection system - an arrangement of detectors and control and indicating equipment employed for automatically detecting fire and initiating other action as arranged.

Fire Alarm Control Panel (FACP) - a panel on which is mounted an indicator or indicators together with associated equipment for the fire alarm or sprinkler system.

Fire resisting - an element of construction, component or structure which, by requirement of the Regulatory Authority, has a specified fire resistance.

Indicating equipment - the part of a fire detection and or alarm system, which provides indication of any warning signals (alarm and fault), received by the control equipment.

Interface - The interconnection between equipment that permits the transfer of data.

Main equipment - equipment essential to the operation of the system including, control equipment, amplification equipment and power supply modules.

Master Alarm Facility (MAF) - that part of the equipment which receives alarm and fault signals from any alarm zone facility and initiates the common signal (alarm and/or fault) for transmission to the fire control station. Bells and other ancillary functions may be initiated from this facility.

Power Supply - that portion of the FACP which supplies all voltages necessary for its operation.

Regulatory Authority - an authority administering Acts of Parliament or Regulations under such Acts.

UNCONTROLLED DOCUMENT

NOTE: Due to AMPAC's commitment to continuous improvement specifications may change without notice.