



ADVANCED WARNING

SYSTEMS

FireFinder ^{PLUS} *Marine*



**Marine Approved
Fire Alarm Control Panel**

**Installation, Commissioning &
Operation Manual**

MAN 3126-0

**WORLD LEADER OF INNOVATIVE SOLUTIONS
IN FIRE DETECTION AND ALARM SYSTEMS**



Responding to a Fire

Access Level 1



The **FIRE** indicator will be illuminated. The applicable zone **ZONE 1** indicator will also be illuminated and more detailed information of the Loop, Sensor and Zones in alarm are displayed on the LCD as follows.

```

FIRST ALARM: L1 D1 Z1                15:31
D.DSC:Loop 1 Sensor 1
Z.DCS:Zone 1
LAST ALARM: L4 D49 Z5                15:31
D.DSC:Loop 4 Sensor 49
Z.DCS:Zone 5 Depend C
PRESS PREVIOUS/NEXT TO VIEW OTHER ALARMS
AC:2Z   ALM:5   PALM:0   FLT:0   DIS:0
    
```

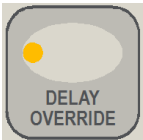

The **DELAY OVERRIDE** button is pressed to override any delays to outputs



The **SILENCE BUZZER** button is pressed to silence the buzzer

Access Level 2



The **EVACUATE** button is pressed to turn ON all alarm devices.



The **ALARMS SILENCE / RESOUND** button is pressed to silence any silence-able outputs that have been activated.



The **ALARMS SILENCE / RESOUND** will be illuminated to indicate that the silence-able outputs have been silenced and resound is available.

The operation of the **SILENCE** button will be logged.

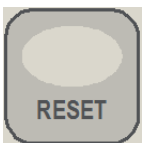

The **RESET** button is pressed to reset the fire condition. All outputs activated in response to the fire will deactivate and the panel will revert to the normal condition providing there are no other abnormal conditions present. – RESET IS LOGGED.

Disabling a Zone / Device



Zone Disablement (Access level 2)

Place the Keyswitch in the ENABLED position.

Press  (If keyswitch not used enter Access level 2 password)

```

FIREFINDER          17/12/2012 09:00:00
ZONE: _____
SELECT ZONE NO. THEN TO OR DISPLAY OR
DEVICE DISABLE/ENABLE KEY
AC:2Z  ALM:0  PALM:0  FLT:0  DIS:0
    
```



then Press  for Zone 1 selection. Now Press the .

```

FIREFINDER          17/12/2012 09:00:00
ZONE:1
0:FULL ENABLE      1:FULL DISABLE
2:SET AUTOMATIC ENABLE TIMER & DISABLE
AC:2Z  ALM:0  PALM:0  FLT:0  DIS:0
    
```

Then select  to Disable the Zone. The applicable Zone indicator (if fitted) will be ON Amber

Device Disablement:

Press the  then enter Loop number, Press  then enter device number.

```

FIREFINDER          17/10/2013 09:00:00
LOOP:1  DEVICE:1
SELECT DEVICE NO. THEN TO OR DISPLAY OR
ZONE/DEVICE DISABLE/ENABLE KEY
AC:2Z  ALM:0  PALM:0  FLT:0  DIS:0
    
```

Now Press the .

In either case the "General" Disable LED will illuminate  and the screen will display the Zone and/or Devices in disablement.

TABLE OF CONTENTS

Page No.

1	About This Manual	1
1.1	Introduction	1
1.2	General Requirements	1
1.3	References.....	1
1.4	Symbols.....	1
2	Introduction	2
2.1	System Overview	2
2.2	Overview & Key Features.....	3
2.3	FACP Configuration Examples	3
3	FireFinder Plus Description	4
4	Placing The Basic System Into Operation	6
4.1	Unpacking.....	6
4.2	Anti-Static Precautions	6
4.3	Working On The System	6
4.4	The Cabinet	6
4.5	Cable Types and Limitations	7
4.6	Power Supplies and AC Mains Installation.....	7
4.6.1	Connecting the Mains Earth.....	7
4.6.2	Connecting Power Supply.....	7
4.7	CORRECT Power Up / Turn "ON" Procedure	8
4.8	Brigade / PSU Monitor Board.....	9
4.8.1	Battery Connections	11
4.8.2	Auxiliary 27 Volt Power	11
4.8.3	Monitored Inputs.....	12
4.8.4	Monitored Outputs.....	13
4.8.5	Relay Output Connections	14
4.9	Main Board.....	15
4.10	Front Panel Board	16
4.11	Main CPU	17
4.12	Slave CPU	18
4.13	Addressable Dual Loop Termination Board.....	19
4.13.1	Detector loop Isolator Installation	20
4.13.2	Loop Isolator calculator.....	20
4.13.3	Loop Open / Short Circuit.	20
5	FireFinder PLUS Control Panel	21
5.1	System Controls.....	21
5.2	System Indicators.....	24
6	Functions And Menus	25
6.1	The Default LCD Display	25
6.2	LCD Contrast	25
6.3	Accessing Functions and Menus	25
6.4	Function Menu and Access Levels	26
6.4.1	Forgotten Passwords.....	26
7	The Main Menu	27
7.1	Alarms	27
7.2	Stage 1 Alarms.....	27
7.3	Pre-Alarms.....	28
7.4	Faults.....	28

7.5	Disables	29
7.6	Walk Tests	29
7.7	Status	30
7.8	Tools.....	34
7.9	Setup	35
7.10	About	36
8	<i>The Function Menu</i>	37
8.1	Date	37
8.2	Time.....	37
8.3	Day/Night.....	38
8.4	Logs.....	38
8.5	TESTS	39
8.6	I/O.....	40
8.7	Global (Network Panels).....	41
8.8	Passwords (Level III).....	42
8.9	Programming	43
8.9.1	Conv (Conventional) Zone	43
8.9.2	Device.....	44
8.9.3	Input.....	45
8.9.4	Output	45
8.9.5	Panel Based MCP	45
8.9.6	Sub Address.....	45
8.9.7	Watchdog.....	45
8.9.8	Zone programming.....	46
8.9.9	Extra Devices Detected	48
8.9.10	Mismatch Detected.....	48
9	<i>Incoming Fire Alarm Signal</i>	49
10	<i>Accessing and Managing a Device or Zone.....</i>	50
10.1	Displaying a Device.....	50
10.2	Disabling a Device.....	50
10.3	Displaying a Zone.....	51
10.4	Disabling a Zone	51
10.5	Zone Disable Timer	52
11	<i>IMO General / Muster Alarm.....</i>	53
12	<i>Modem / Programming / Debug Interfacing.....</i>	54
13	<i>Expanding the FACP with Compatible FireFinder PLUS Boards.....</i>	55
13.1	Ancillary Services.....	55
13.2	Compatible <i>FireFinder PLUS</i> Boards	55
13.3	8 Zone Conventional Board	56
13.4	32 Zone Alarm Mimic Card	57
13.5	16 Way Input Board.....	58
13.6	8 Way Relay Board	59
13.7	8 Way Sounder Board	60
14	<i>Expanding the System Through Networking.....</i>	61
14.1	Networking.....	61
14.2	Network Interface Card.....	61
15	<i>High Level Interfacing.....</i>	63
15.1	HLI.....	63
15.2	SmartView.....	63
15.3	MODBUS interface.....	63
15.4	VDR interface.....	63

16	Certification Information.....	64
17	Maintenance and Troubleshooting Chart	65
17.1	Maintenance	65
17.2	Troubleshooting <i>FireFinder PLUS</i>	66
18	Compatible Devices	67
18.1	Apollo Discovery Intelligent Detectors.....	67
18.2	Apollo Intelligent Flame Detectors	67
18.3	Apollo Intelligent Manual Call Points & Interfaces	67
19	Address Setting	68
20	Specifications.....	69
21	QUICK REFERENCE GUIDE.....	70

1 About This Manual

1.1 Introduction

This manual contains all the information required to install, commission and operate the **FireFinder PLUS** Fire Alarm Control Panel (FACP) and is only available to and for the use of personnel engaged in its installation, commissioning and operation.

1.2 General Requirements

The **FireFinder PLUS** FACP has been designed and manufactured from high quality commercial components so as to comply with major world standards. To ensure these standards are not compromised in any way installation staff and operators should;

- Be qualified and trained for the task they undertake;
- Be familiar with the contents of this manual prior to the installation, commissioning or operation of a **FireFinder PLUS** control system;
- Observe anti-static pre-cautions at all times; and
- Be aware that if a problem is encountered or there is any doubt with respect to the operational parameters of the installation the supplier should be contacted.

1.3 References

ConfigManager: Operation Manual

Apollo: Detector / Device Manuals

Ampac: Product Data Sheets

European Standard:

EN54.2-1998: Fire Detection and Fire Alarm Systems. Control and Indicating Equipment

EN54.4-1998: Fire Detection and Fire Alarm Systems. Power Supply Equipment

IEC60092-504:2001 Electrical Installations in ships, special features, control and instrumentation

IEC60533:1999 Electrical and electronic installations in ships, electromagnetic compatibility

1.4 Symbols

 Important operational information

 **Note:** Configuration considerations

 Observe antistatic precautions

 Mains supply earth

 DANGER mains supply present

2 Introduction

2.1 System Overview

The purpose of the **FireFinder PLUS** Fire Alarm Control Panel (FACP) is to monitor changes in inputs, report those changes and update selected outputs as programmed.

The **FireFinder PLUS** FACP is compliant with EN54-2 and EN54-4.

In addition to the mandatory requirements of EN54-2 the **FireFinder PLUS** FACP meets the following optional features with requirements:

- 7.8 Output to fire alarm devices
- 7.9 Control of fire alarm routing equipment
- 7.9.1 Output to fire alarm routing equipment
- 7.9.2 Alarm Confirmation input from fire alarm routing equipment
- 7.11 Delays to outputs
- 7.12 Dependencies on more than one alarm signal Type A, B and C
- 8.3 Fault signals from points
- 8.9 Output to fault warning routing equipment
- 9.5 Disabling of each addressable points
- 10 Test condition

Note: The **FireFinder PLUS** FACP has the capabilities to include functions and features that are additional to the requirements of EN54-2. These additional functions and features are outlined in this manual.

2.2 Overview & Key Features

The **FireFinder PLUS** is an Intelligent Analogue / Addressable and / or Conventional Fire Alarm

Control Panel capable of supporting:

- Apollo Discovery and XP95 Intelligent Detectors, Multisensor, Photoelectric, Ionisation, Thermal (heat) and CO detectors..
- Addressable Initiating Devices: Modules that monitor any conventional normally open contact such as supervisory switches and flow switches.
- Conventional two wire zone detector circuits
- Multiple input/outputs
- High Level Interfaces - VDR
- **SmartView** Graphical User interface

2.3 FACP Configuration Examples

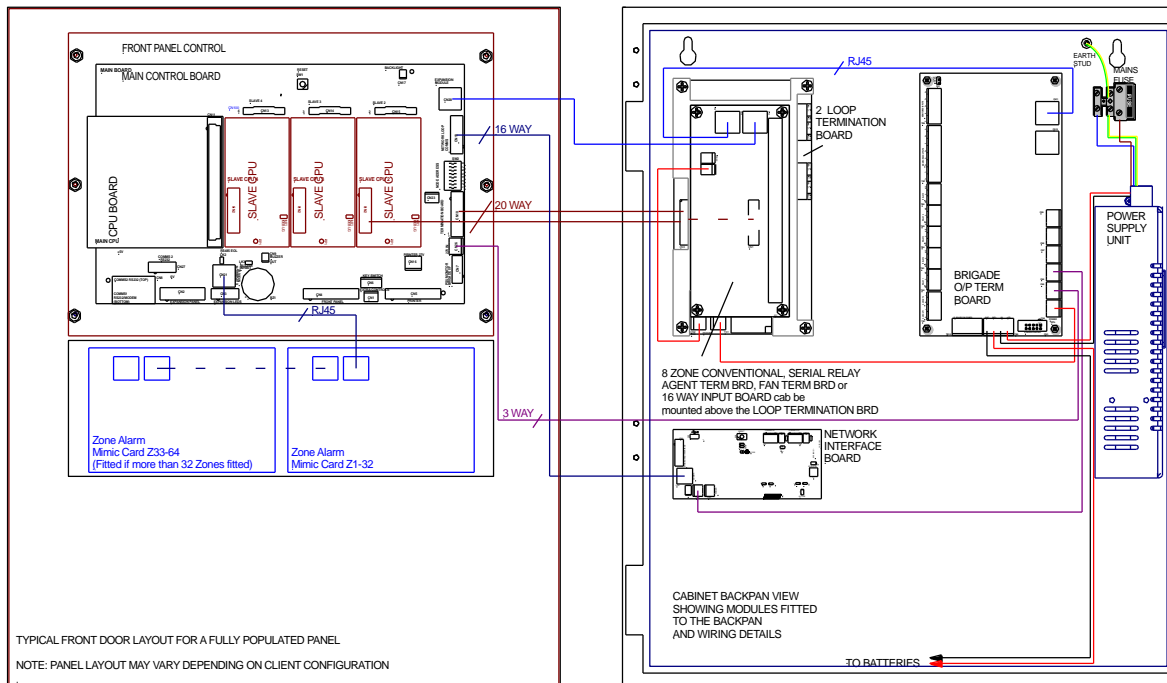

Figure 1: Typical Example of a SP1M Layout

3 FireFinder Plus Description

The following description does not relate to specific cabinets as the size of each cabinet will vary with the amount of hardware fitted.

The heart of the **FireFinder PLUS** consists of two boards collectively known as the **Controller**. These boards are the Main Board and the CPU board. Combining these two boards with a front panel forms the basis for a **FireFinder PLUS** FACP. A single **Controller** without an expansion board has the capacity to interface to four (4) Slave CPU's modules. These Slave CPU's can be used for Loop Termination Boards.

The Main Board has the Slave CPU Board for the first Loop Termination Board and the provision for mounting of up to three additional Slave CPU's to interface to loops 2 - 4. The Slave CPU's all have the same software installed and the manner in which they operate is automatically determined by the type of termination or interface board onto which they connect.

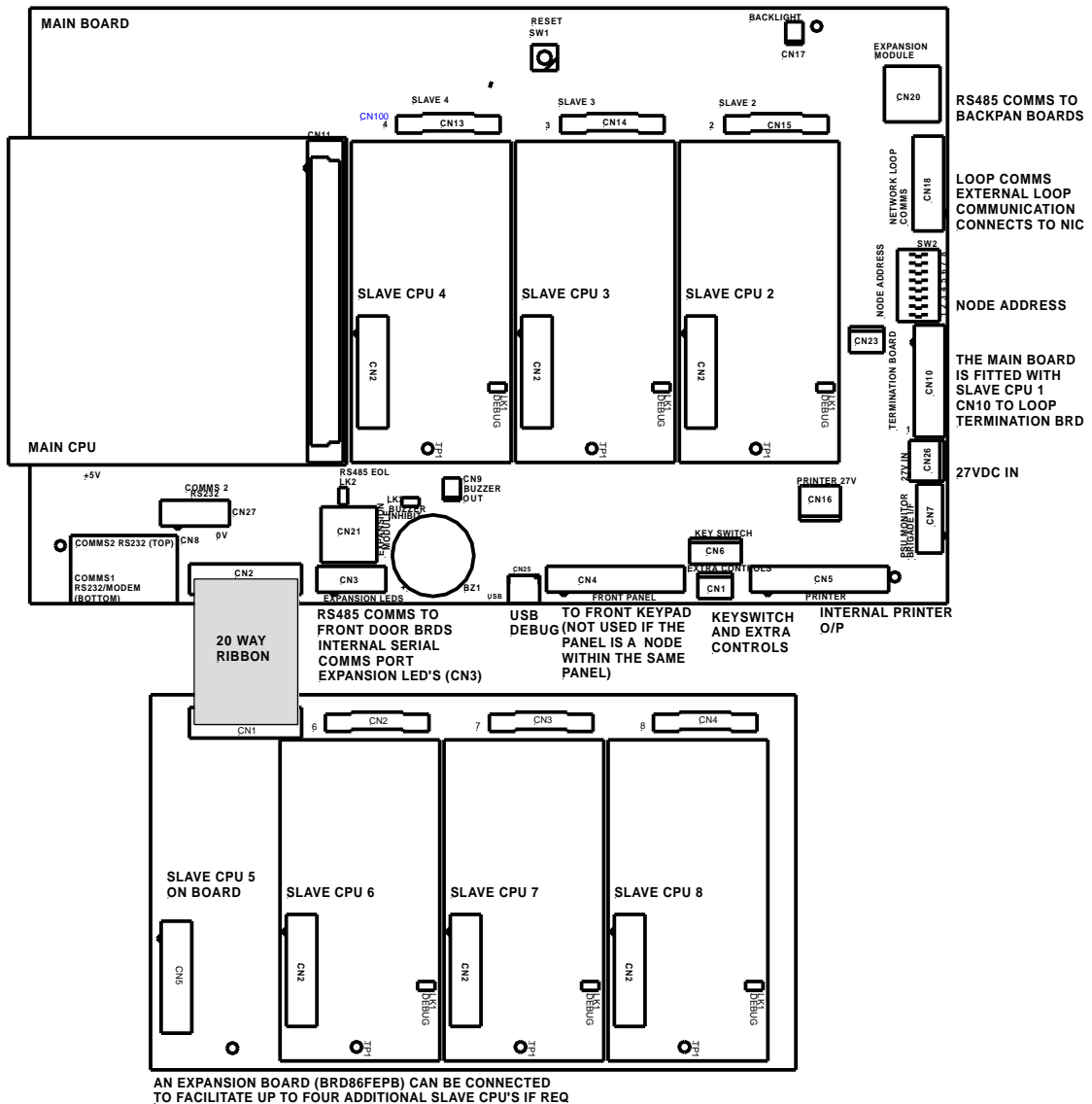

Figure 2: Single Controller Board with Expansion Board

FireFinder PLUS has an internal RS485 communication bus that allows for various ancillary boards (add on modules) to be connect to the panel. These boards can be used to control and monitor field plant equipment.

Where the system design exceeds the capability of one **FireFinder PLUS** then other **FireFinder PLUS** panels can be networked together to provide an expanded system containing multiple boards in a variety of applications.

Some of these applications include:

- A Master / Slave (Main Sub) FACP arrangement (MFACP / SFACP)
- A Peer to Peer System
- Use of Data Gathering Panels (DGP's)

A Network **FireFinder PLUS** System supports a combination or all these options on a single network. Each panel on the network is regarded as a "node". The NETWORK BUS is accessed using a Network Interface Card (BRD86NIC). The network configuration determines whether a NIC is required. Configurations can be;

Master / Sub FACP: Where there is one or more FACP's configured as local panels then each report the status of their associated zones/devices to a MFACP. There is no control between local panels as the MFACP is structured to have full control of the entire system.

Peer to Peer: Each FACP user can take control of the entire fire system from any FACP.

Data Gathering Panel: The use of this type of panel may be installed where there is a need to have field terminations only at one location and all control is performed by an FACP that is remotely located.

4 Placing The Basic System Into Operation

4.1 Unpacking

Carefully unpack the **FireFinder PLUS**.

The package should include:

- **FireFinder PLUS** Fire Alarm Control Panel
- An Operators manual
- 003 keys

4.2 Anti-Static Precautions

To prevent damage to components, modules and boards, anti-static precautions **MUST** be observed while performing any task within the FACP. The same applies to those situated in the field



4.3 Working On The System

Prior to unplugging any connector, connecting or disconnecting any wiring, removing or replacing any module or board, ensure that both the Mains and Batteries have been isolated to prevent damage to panel components.

4.4 The Cabinet

Features:

- The cabinet is available in four different styles. Each style has the capability of being either surface or flush mounted. With flush mounting though a surround is required.
- Normally painted Surf Mist Ripple. Other colours are available on request.
- The inner and outer door hinges are mounted on the left-hand side of the cabinet which allow the doors open to an angle of 100°. A keyed entry is provided
- Knockouts are positioned on gland plates and a cut out is available on the rear of the cabinet to simplify cable entry. Mounting The Cabinet



Note: *It is recommended the cabinet should be installed in a clean, dry, vibration-free area.*

Open the front door. Use the keyhole mounting holes in the top corners and in the lower middle of the unit to mount it on the wall. Cables to connect the system to its external actuating devices are brought in through the knockouts on the top or bottom of the cabinet.

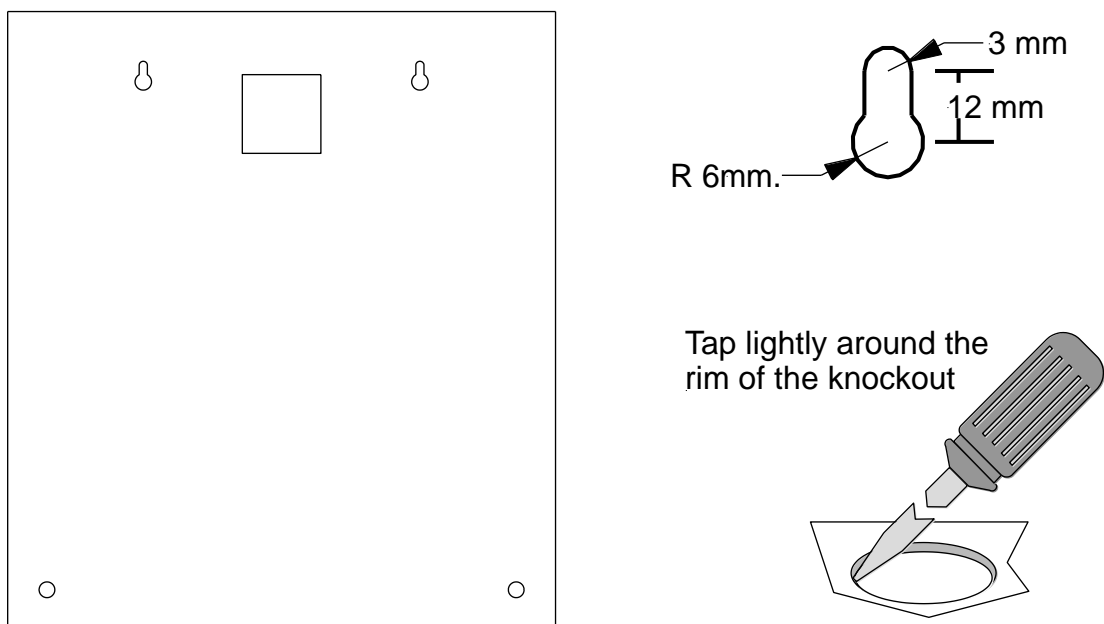

Figure 3: Example SP1 Back Pan Mounting Hole & Removing Knockouts

4.5 Cable Types and Limitations

All System wiring should be installed in accordance with the applicable wiring regulations where the panel is being installed.

To comply with EMC (Electro Magnetic Compatibility) regulations and to reduce the risk of electrical interference in the system wiring, we recommend the use of Fire-resistant screened cables throughout the installation, examples of which include the following:

Manufacturer	Cable Type	CoreSize (mm ²)		
		1	1.5	2.5
Ventcroft*	No Burn Platinum	✓	✓	✓
Ventcroft	Diamond	✓	✓	✓
Prysmian cables & systems Ltd	FP200 Gold LSOH	✓	✓	✓
Prysmian cables & systems Ltd	FP Plus	✓	✓	✓
AEI Cables Ltd	Firetec Multicore LSZH	✓	✓	✓
CAvicel SpA	Firecel SR/114H	✓	✓	✓
Tratos Cavi SpA	FIRE-Safe TW950	✓	✓	✓
Eland Cables	FireForce	✓	✓	✓
Draka	Firetuf (OHLS)	✓	✓	✓
Draka	Firetuf Plus	✓	✓	✓

* For LPCB approval the panel was tested with Ventcroft No Burn Platinum 1.5mm² cable.



Note: All cable screens should be terminated to chassis as close as possible to the top gland plate for EMC compliance.

Mains Cable Type

For mains power cable it is recommended to use the following cable or equivalent:

2 Core and Earth EMC/VSD Braided Screen Flexible Power cable 0.6/1kV – EMC3G1.5CL

4.6 Power Supplies and AC Mains Installation

Generally, the AC Mains will be connected to either a 5 Amp 27 volt supply via a Fused terminal block.

The supply will be mounted in the upper right-hand corner of the cabinet with the Brigade Board mounted beside the power supply.

The wiring should enter the cabinet through the nearest knockout entry hole on that side.

Refer to Figure 4 for the wiring and fusing details.

4.6.1 Connecting the Mains Earth

The mains earth shall be terminated to the Earth Terminal on the Fused terminal block.

4.6.2 Connecting Power Supply

Output Voltage: 27.4 Volts.

FUSE Rating 5A PSU: 2 Amp 3AG Slow Blow

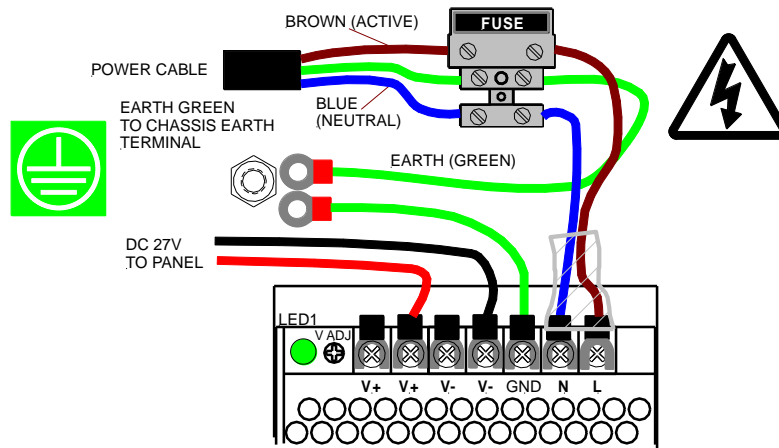

Figure 4: Mains Power Connection to the Power Supply

4.7 CORRECT Power Up / Turn “ON” Procedure

Once all the field devices are installed and the wiring has been correctly terminated the **FireFinder PLUS** is ready to turn on. For reliable power up it is essential the following procedure be followed:

1. Turn the Mains power on, **THEN**
2. Connect the batteries observing correct polarity.
3. The green power on LED should be illuminated.

4.8 Brigade / PSU Monitor Board

The Brigade / PSU Monitor Board (BRD86BPSC) monitors and controls the power supply, battery charging, monitored / un-monitored inputs, outputs and the 5 relay outputs.

Connections

TB(x)	Function	Type of Output
TB1	Aux Out x 2	Protected
TB2	Relay 1	1 Amp Voltage Free Contacts
TB3	Relay 2	1 Amp Voltage Free Contacts
TB4	Relay 3	1 Amp Voltage Free Contacts
TB5	Relay 4	1 Amp Voltage Free Contacts
TB6	Relay 5	1 Amp Voltage Free Contacts
TB7	Monitored Outputs x 4	24Vdc 10K EOL
TB8	Monitored Inputs x 4	Switched Negative, 10K EOL
TB9	Battery Out / 27VDC PSU IN	Protected
TB10	External Board / SW POWER	
CN(x)	Function	Type of Output
CN1	JTAG	
CN1	SGD	
CN3	External Board Controls	
CN4-8	Power Out	1 Amp (protected)

Relay Information

Voltage Free contacts are rated at 1A @ 30V

Back EMF Protection

i Inductive loads fitted to the Brigade PSU Monitor Board **MUST** be fitted with “Flyback” diodes at the load for back EMF protection.

Transient Protection

i Recognised transient line protection methodologies at the FACP and the load **MUST** be considered when connecting any control devices to the outputs be they in close or remote.

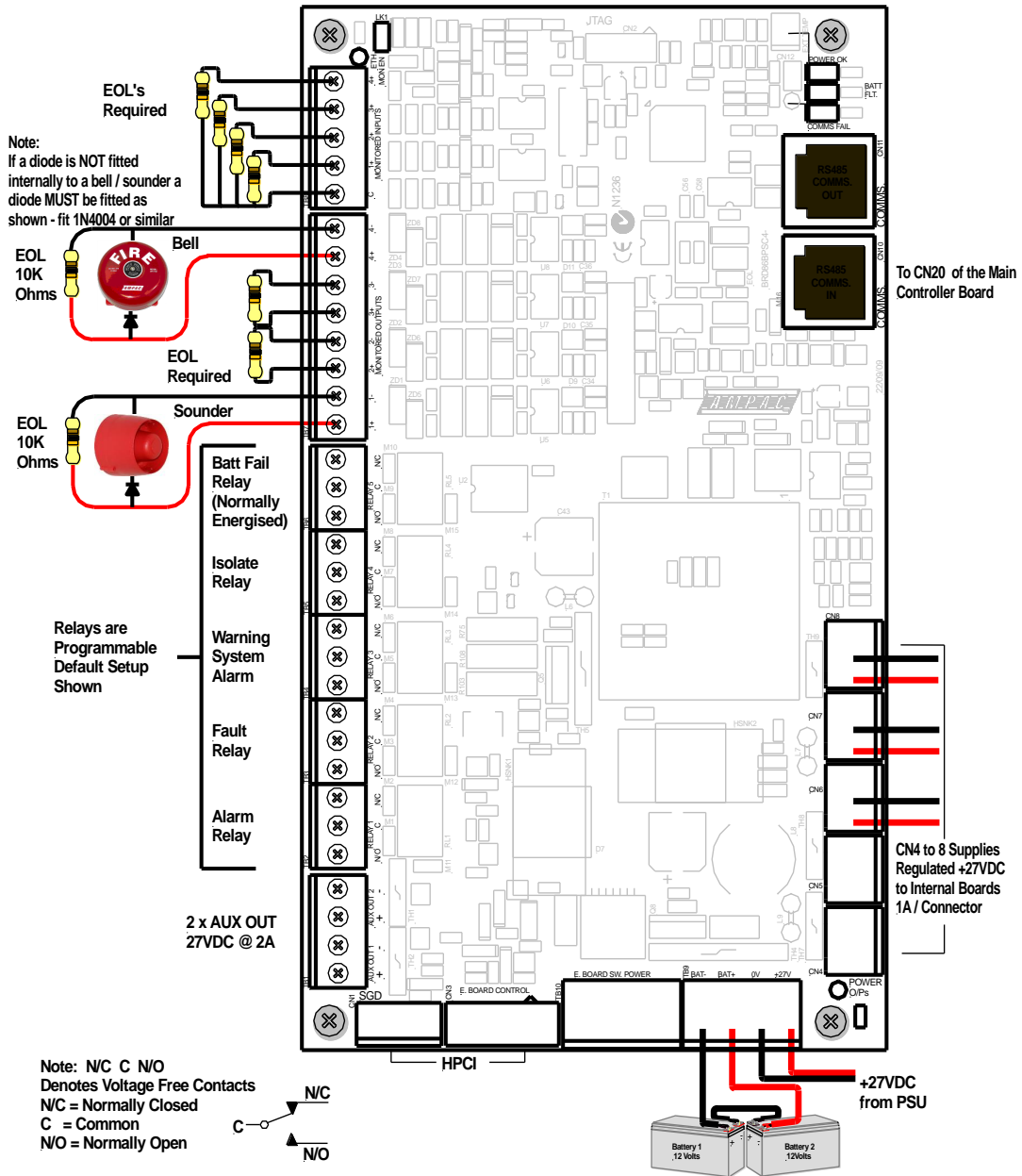

Figure 5: Brigade / PSU Monitor Board Layout

Note: When connecting to the Brigade PSU Monitor board transient and “Flyback” (Back EMF) protection methodologies MUST be applied.

4.8.1 Battery Connections

A **FireFinder PLUS** requires two (2) 12 volt batteries (TB9). The batteries should be placed into the bottom right hand side of the cabinet.

A red and black lead coming from TB1 on the Brigade Board will be clearly seen in the same area, this lead is to be connected to the batteries red to positive and black to negative once the system is operating on Mains supply.

Note: The cabinet supports 26Ahr batteries.

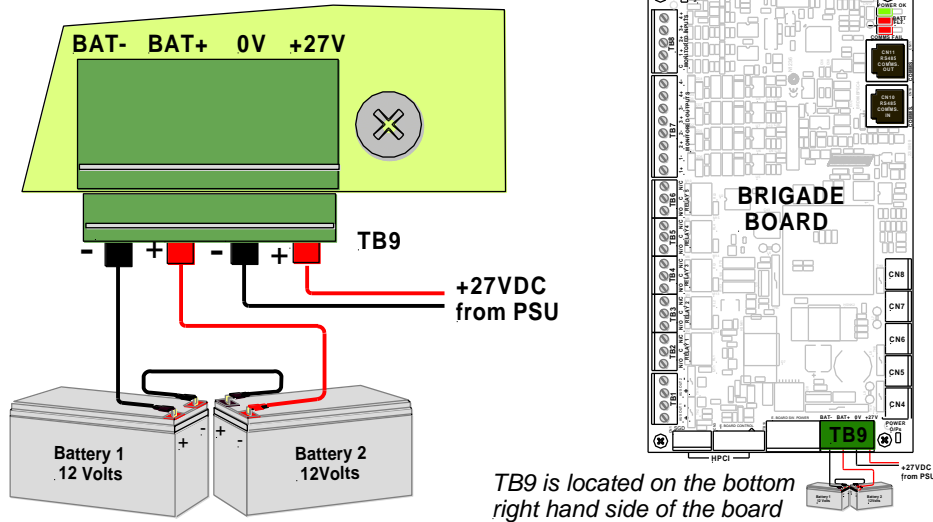

Figure 6: Battery Connections to the Brigade / PSU Monitor Board

4.8.2 Auxiliary 27 Volt Power

Two (2) 1 Amp outputs are available from TB1 terminals 1+ (plus) and 2- (minus) or 3+ and 4- on the Brigade Board. It is important to note these outputs are short circuit monitored.

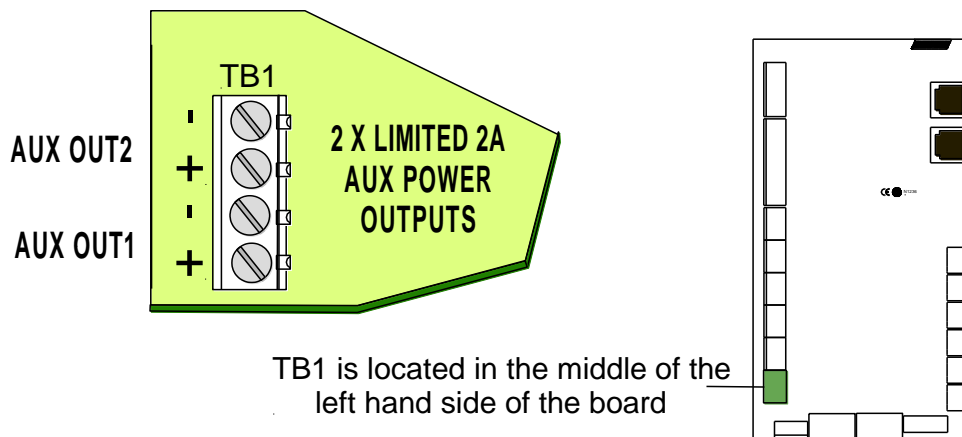

Figure 7: Auxiliary 27VDC Power Output

4.8.3 Monitored Inputs

Four independently monitored inputs (TB8) are provided and can be configured for a variety of uses.

- **Class Change** – if activated all Sounders and Sounder Outputs in Sounder Group 1
- **External Fault** – if activated the FACP will indicate a Fault condition
- **Ancillary Disable** - if activated, the FACP's "DISABLED" and ANC OUTPUT STATUS LEDs will both be turned on. Note that this event is used to indicate an ancillary/auxiliary disablement or a door-opened condition if a door switch is fitted. It also activates any Relays on the Brigade board configured as "Isolate" relays and affects the Brigade Board's "Aux/Anc" outputs based on their "normally energised" settings.
- **Evacuate** – if activated the FACP goes into Evacuation.
- **Sounder Silence** – if activated all activated sounders are silenced.
- **Reset** – if activated a Master Reset is initiated.
- **Fire/Feedback** - if activated, the FACP's "Fire Output On" LED will flash (EN54-2 Clause 7.9.2). Note that this is a latched condition and will only be cleared a "Master Reset" command from the FACP.
- **General Purpose** – for use in Functions (Cause and Effects)
- **General/Muster Alarm** – if activated the FACP will enter the IMO General Alarm condition and any outputs or sounders configured as General/Muster Alarm will be activated
- **Mains Supply fault** – Used as a feedback when the Dual Mains supply changeover board is fitted

The default configuration types for the inputs are as follows:

- Input 1 – External Fault
- Input 2 – Reset
- Input 3 – Sounder Silence
- Input 4 – Fire/Feedback

The inputs have been designed to operate with a programmable EOL of 3K3Ω, 10KΩ 22KΩ or Unmonitored (no EOL) the 10K EOL is the default. The normal and active ranges change according to the end of line selected.

Line resistance (10K EOL)	Sensed Condition
0Ω– 150Ω	Short circuit Fault
500Ω – 4KΩ	Active condition
8KΩ – 15KΩ	Normal
20KΩ to ∞	Open circuit Fault

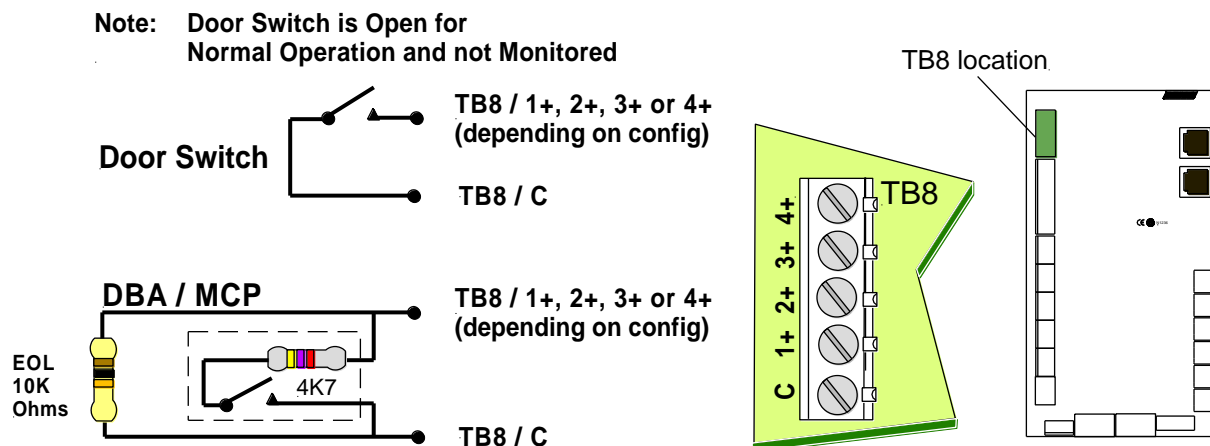

Figure 8: Inputs DBA / MCP and Door Switch Wiring

4.8.4 Monitored Outputs

Four independently monitored and controlled outputs (TB7) are provided and can be configured for a variety of uses.

- **Alarm devices** - activated when any of its four sounder groups is active. (EN54-2 Clause 7.7 and 7.8). The output is turned off during an Alarm (sounder) disable or Alarm (sounder) silence condition.
- **Fire / FARE** – activated by alarm condition (EN54-2 Clause 7.7 and 7.9.1). The output is turned off during a FARE disable condition.
- **Ancillary** - activated on device alarm conditions. The output is turned off during an Auxiliary disable condition.
- **Muster** - activated on General/Muster alarm conditions. The output is turned off during an Alarm (sounder) disable or Alarm (sounder) silence condition.
- **Fault** - activated on all fault conditions (EN54-2 Clause 8.9). The output is turned off during a FWRE disable condition.
- **General Purpose** – activated via the ConfigManager “Function” programmed logic.

These monitored switched outputs, supply a **nominal 24VDC, at up to 1 Amperes**.

Monitoring is for short, open and earth faults when the output is OFF.

The outputs have been designed to operate with a programmable EOL of 3K3Ω, 10KΩ 22KΩ or Unmonitored (no EOL) the 10K EOL is the default.

Line Impedance (10K EOL)	Reported Condition
0Ω – 50Ω	Short circuit Fault
50Ω – 150Ω	Indeterminate: Maybe reported as shorted or normal
150Ω – 15KΩ	Normal
15KΩ – 40KΩ	Indeterminate: Maybe reported as normal or open circuit
40KΩ to ∞	Open circuit Fault

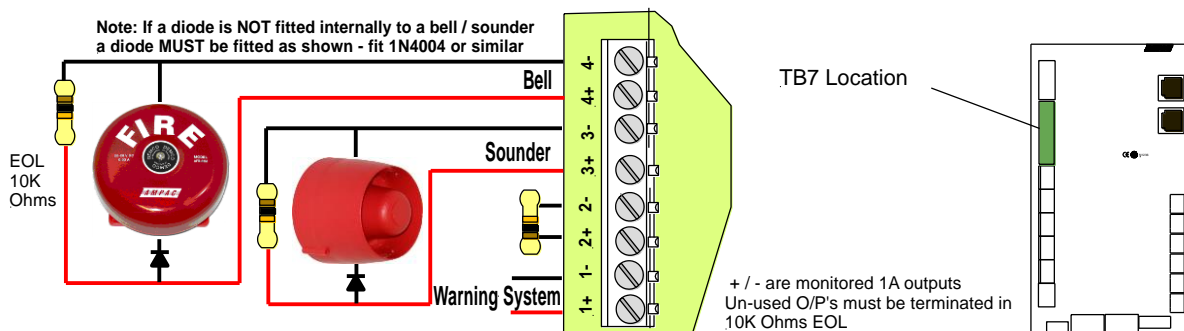

Figure 9 Connecting a Bell / Sounders

4.8.5 Relay Output Connections

Five “voltage free” relay outputs (TB2 – TB6) are provided and can be configured for a variety of uses.

- **Fire/FARE** - activated on device alarm conditions and “Function” programmed logics. The relay is turned off during a FARE disable condition.
- **Sprinkler** - activated on device alarm conditions and “Function” programmed logics.
- **Fault** - activated on all fault conditions and “Function” programmed logics. The relay is turned off during a FWRE disable condition.
- **Disable** - activated on all Disable conditions and “Function” programmed logics.
- **Battery Fail** - activated on battery fail conditions and “Function” programmed logics.
- **Mains Fail** - activated on a mains failure.
-
- **Ancillary** - activated on device alarm conditions if selected on the Loop device configuration table.
- **General Purpose** - activated via “Function” programmed logics

These outputs have been designed to be able to switch predominately resistive loads as listed below.

Switching voltage	Maximum switching current
30VDC	1A
24VAC	1A
50VDC	250mA
40VAC	250mA

The relay contacts are connected as shown below.

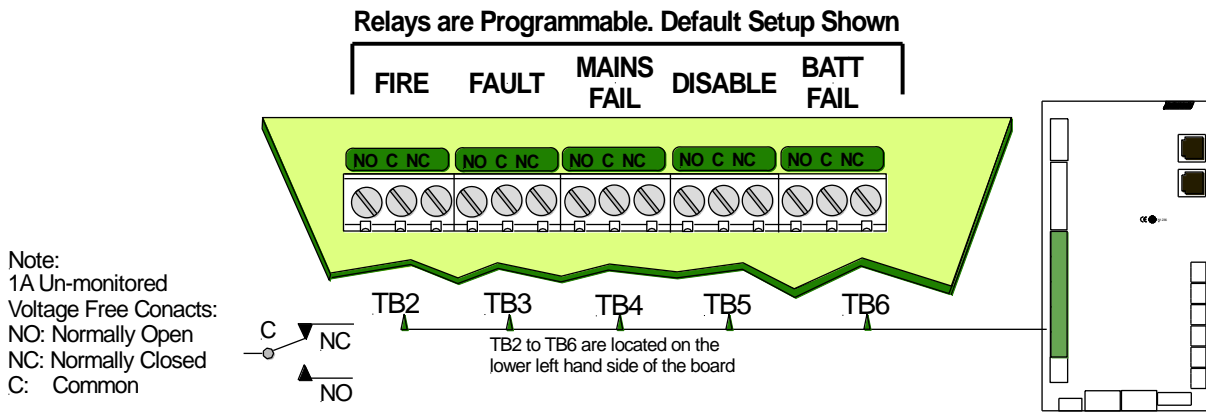

Figure 10: Relay Outputs

4.9 Main Board

The Main Board (BRD86MBA) carries the devices for interconnecting to all the other Boards, a buzzer for auditory indication, the backlight power supply for the LCD and CPU Reset.

The Main CPU is mounted on this board and connected to it by CN11. The main connection board then provides interfacing to

- Up to 3 Slave CPU's (Slave CPU 1 is onboard)
- A printer
- A Modem
- An Expansion Panel
- An Internal serial bus
- An External communication bus.

Connections

CN1	Extra Control (Not Fitted)	CN15	Slave CPU connection
CN2	Expansion Panel	CN16	Printer 27VDC Out
CN3	Expansion LED's (Not Fitted)	CN17	To LCD Backlight supply
CN4	Front Keypad	CN18	External Loop Communication
CN5	Printer	CN19	LCD Characters
CN6	Key Switch (Not Fitted)	CN20	RS485 Communications Port 1
CN7	Brigade Output	CN21	RS485 Communications Port 2
CN8	Modem and RS232 Comms	CN22	To LCD Backlight supply
CN9	External Buzzer Output	CN23	Slave CPU Debug (Not Fitted)
CN10	Slave CPU output 1	CN24	Jtag Programming Slave CPU1 (Not Fitted)
CN11	Main CPU	CN25	USB Programming
CN12	LCD Graphic	CN26	27VDC In
CN13	Slave CPU connection	CN27	Comms 2 RS232
CN14	Slave CPU connection	CN28	27VDC In (not fitted)

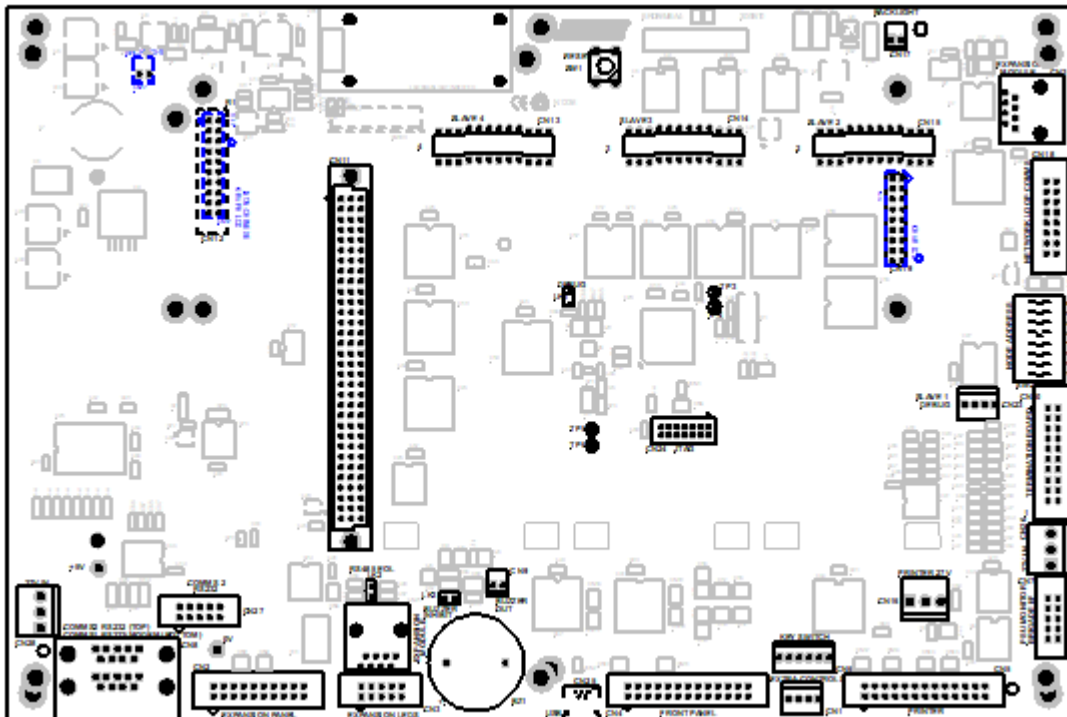

Figure 11: Main Board Layout with no Main CPU or Slave CPU's

4.10 Front Panel Board

The Front Panel Board (BRD86FPB) provides the buttons used to control the FACP as well as all LED indications. All LED's are surface mounted and the buttons are embedded within the board. The LCD is viewed / protected by a clear Perspex screen.

Connections

CN2	To CN4 Main Board
-----	-------------------

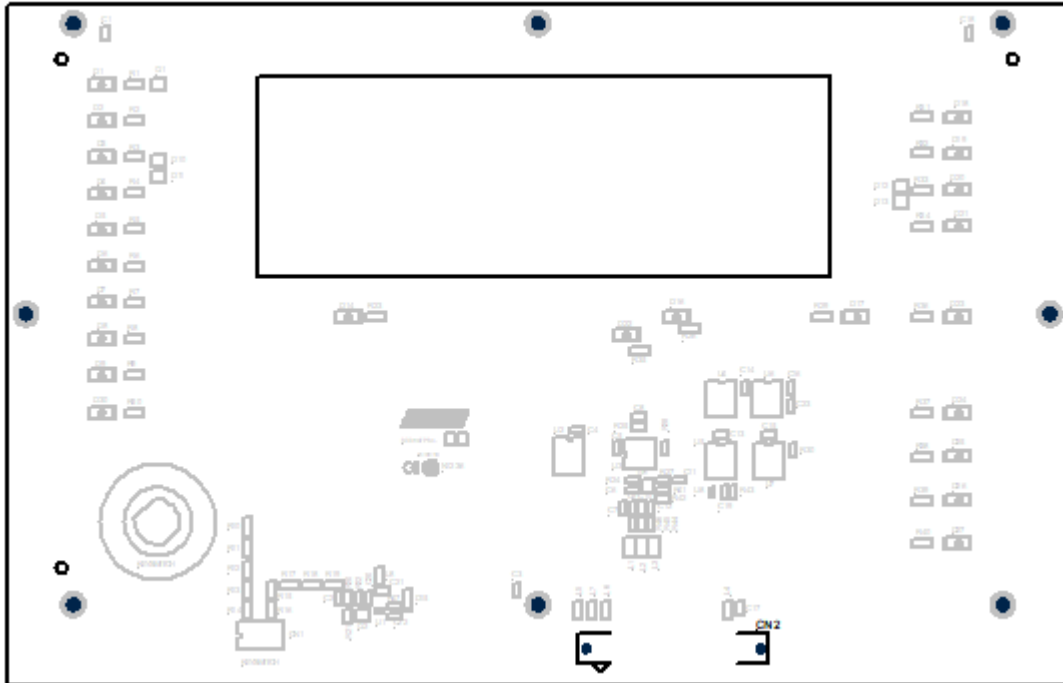

Figure 12: Front Panel Board

4.11 Main CPU

The Main CPU (BRD86MCP) holds the main central processing unit including the Application software and Configuration settings for the FACP.

- The Main CPU is a 4-layer surface mount board
- The processor runs at 60MHz.
- 16Mbytes of FLASH
- 32/64 Mbytes SDRAM

Connections

CN1	USB (Not Fitted)
CN2	To Main Board CN11

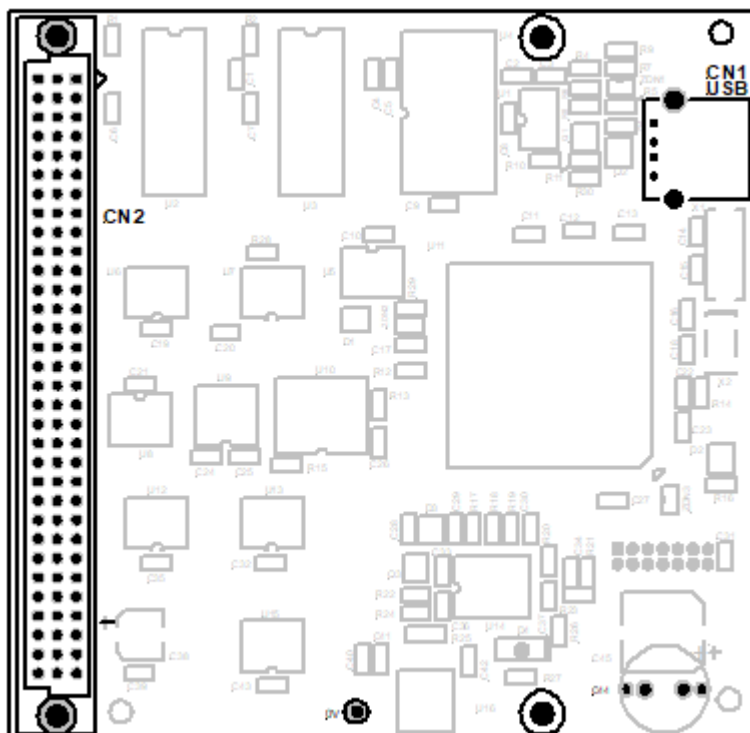

Figure 13: The Main CPU Board PCB Layout

4.12 Slave CPU

The Slave CPU (BRD86SCPU) provides the interfacing signals and I/O's required to allow the FACP to connect / communicate to a variety of termination boards.

A single chip micro controller U7 controls all operations of the FACP Slave CPU. This device contains the control program within Read Only Memory (ROM).

Automatic Termination Board Sensing

A unique feature of the Slave CPU is its ability to automatically sense the type of board it is connected to without the user having to configure the board to suit.

Connections

CN2	To Loop Termination Board
CN3	To Main Control Board

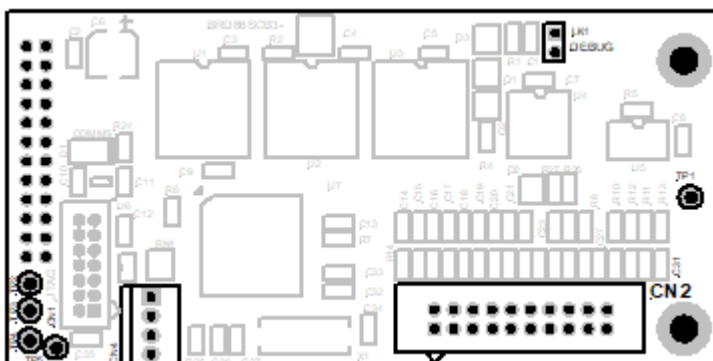

Figure 14: Slave CPU Board

4.13 Addressable Dual Loop Termination Board

The Addressable Dual Loop Termination Board (BRD86DLTB) acts as the interface between the external addressable devices and the control and monitoring functions of the **FireFinder PLUS**. Each board provides terminations for two loops and can be used with the Apollo range of detectors. One slave CPU is required per loop.

Note: Apollo devices L2 is +ve (positive), L1 is -ve (negative)

AMPAC strongly recommend that the **LoopManager** test set is used to check that the Apollo loop has been correctly installed and commissioned before connecting it to the **FireFinder PLUS**.

Loop Parameters

- 126 Apollo Devices (i.e. maximum address range)
- 500mA Current Max
- S/C protection circuitry activates at approximately 650mA
- Maximum length 1km

Note: To achieve full current, the Loop Trip current in Loop Parameters needs to be set to 300mA (**ConfigManager**)

CONNECTIONS

CN1 / 2	To Slave CPU Board
CN3 / 4	27VDC in / out
TB1 / 2	To Addressable loop devices

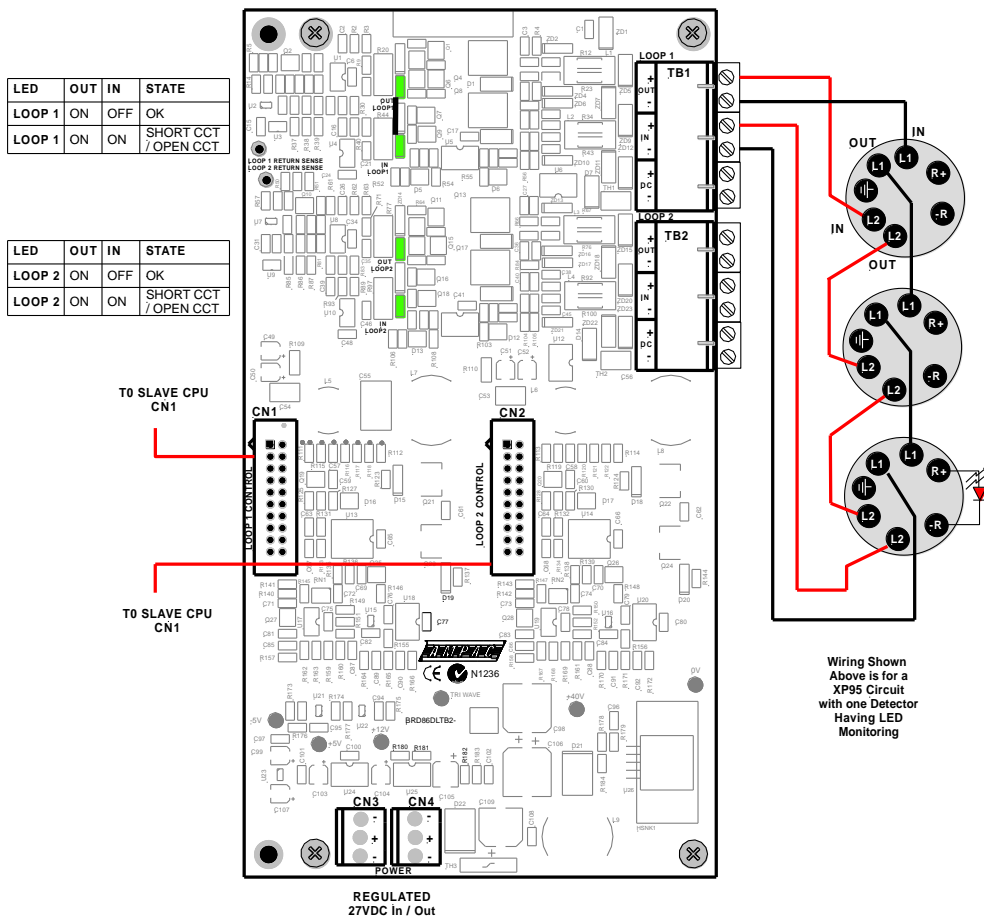

Figure 15: Addressable Loop Termination Board

4.13.1 Detector loop Isolator Installation

In applications where it is not necessary to use an isolating base for each detector, up to 20 detectors may be installed between isolating bases.



Note: Refer to Apollo Isolating specifications and guidelines for further details.

If a short circuit or abnormally low impedance occurs, the base isolates the negative supply in the direction of the fault. When the short circuit is removed the power will automatically be restored.



Note: Isolating base is polarity sensitive.

4.13.2 Loop Isolator calculator

The number of isolating devices on the loop can limit the maximum loop cable length depending on the type of cable used and the total loop current. Refer to the tables below as a guide.

Number of Isolators	0	5	10	15	20	25	30	35	40	45	50
Loop Current Total(mA)	MAX CABLE LENGTH using 1.5mm ²										
50	1000	1000	1000	1000	1000	1000	1000	1000	1000	1000	1000
100	1000	1000	1000	1000	1000	1000	1000	1000	1000	1000	1000
150	1000	1000	1000	1000	1000	1000	1000	1000	1000	1000	1000
200	1000	1000	1000	1000	1000	1000	1000	1000	1000	1000	960
250	1000	1000	1000	1000	973	933	893	853	813	773	733
300	971	931	891	851	811	771	731	691	651	611	571
350	850	810	770	730	690	650	610	570	530	490	450
400	756	716	676	636	596	556	516	476	436	396	356
450	680	640	600	560	520	480	440	400	360	320	280
500	618	578	538	498	458	418	378	338	298	258	218
Number of Isolators	0	5	10	15	20	25	30	35	40	45	50
Loop Current Total(mA)	MAX CABLE LENGTH using 2.5mm ²										
50	1000	1000	1000	1000	1000	1000	1000	1000	1000	1000	1000
100	1000	1000	1000	1000	1000	1000	1000	1000	1000	1000	1000
150	1000	1000	1000	1000	1000	1000	1000	1000	1000	1000	1000
200	1000	1000	1000	1000	1000	1000	1000	1000	1000	1000	1000
250	1000	1000	1000	1000	1000	1000	1000	1000	1000	1000	1000
300	1000	1000	1000	1000	1000	1000	1000	1000	1000	1000	952
350	1000	1000	1000	1000	1000	1000	1000	950	883	817	750
400	1000	1000	1000	1000	993	926	859	793	726	659	593
450	1000	1000	1000	933	867	800	733	667	600	533	467
500	1000	964	897	830	764	697	630	564	497	430	364



Note: For complete Loop calculations the Apollo Loop Calculation tool should be used.

4.13.3 Loop Open / Short Circuit.

In the case of an Open Circuit or Short circuit (short circuit isolators used) on the Loop Line the Loop board provides the ability to drive out from both sides of the loop (In and Out). When these Faults are repaired / cleared the panel will still report a Loop Fault until a Loop Test is performed on the appropriate loop. See section 8.5

5 FireFinder PLUS Control Panel

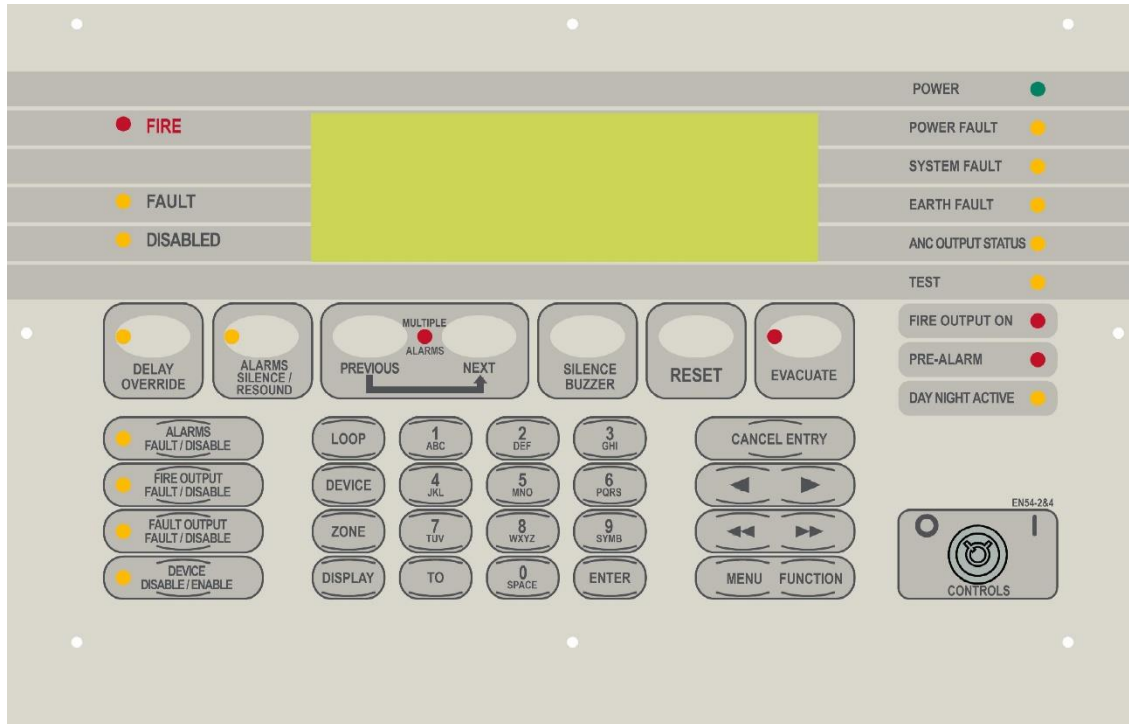
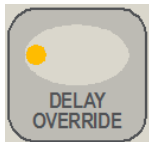

Figure 16: The **FireFinder PLUS** Control Panel with an 8 Line LCD

The LCD is used to display abnormal conditions and for interrogation, control and programming activities. When the FACP is in its normal state a default screen is displayed.

In access level 2 or higher the backlight shall always be ON. Alarm, Fault and Disable information is accessed through the Main Menu.

5.1 System Controls



Pressing this button (EN54-2 clause 7.11), when the Delay Mode is ON and one or more zones configured with investigation delays have their delay timer running, activating the DELAY OVERRIDE control overrides the investigation delay timer allowing the zone or zones to enter the fire condition immediately.

Indicator is illuminated steady when one or more zones are configured with Investigation delays and Delay Mode is active. The indicator will flash if any Investigation delay timer is running.

If the DELAY OVERRIDE control or EVACUATE control is activated while the investigation delay timer is running, then the indicator will go steady and the investigation zone enters the fire condition.

The LED indicator will only be OFF if:

- The Delay Mode is OFF
- No investigation delays are configured
- The panel has switched to day or night mode where no delays have been configured.



Pressing this button will silence any Bells or Sounders (activated either by a fire alarm, a manual evacuation or a manual alert) that are connected to the fire panel. If the bells or sounders are silenced the LED just beside the button will be illuminated steady indicating that the sounders have been silenced and a sounder resound is available. If a manual evacuate or manual alert condition is present when the Sounder Silence button is pressed, these conditions will remain visible indicating

the conditions are still present for resounding. A new Fire Alarm, manual evacuate or manual alert will resound all the previously silenced Bells and Sounders. Pressing ALARMS SILENCE/RESOUND a second time while the Sounder Silence LED is illuminated, will also re-sound the Bells and Sounders.

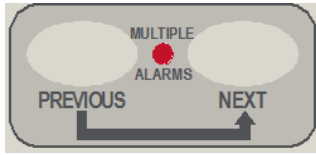

This button is used for scrolling backwards and forwards through fire alarms, faults, or disablements displayed on the LCD. The Multiple Alarm LED will illuminate if there is more than one alarm present



Pressing this button will silence the panel buzzer, which sounds whenever there is a fire alarm or fault. The sound for a fire alarm is a steady sound whereas for a fault it is intermittent.



Pressing this button will reset the panel, clearing any fire alarms and taking the LCD display back to its default screen, unless there are any un-cleared faults or disabled devices, these will continue to be displayed. Pressing reset will also clear the manual evacuate, the manual alert condition and the sounder silence condition. Note: Pressing reset will not clear any disablements including Sounder Disable.



Pressing this button will activate the Sounders and Bells that have been programmed for manual evacuation and the LED just above the button will be illuminated steady. If the sounders have been previously silenced the LED above the ALARMS SILENCE/RESOUND button will turn off and the Sounders and Bells that were previously silenced will resound. This manual evacuate condition can only be cleared by a Reset and will override a manual "Alert" condition.



The LED is illuminated steady if any of the alarm devices (sounders and/or strobes) have been disabled and flashes if any of the alarm devices (sounders and/or strobes) are in fault. Disable has priority over fault



Pressing this button disables any programmed monitored FARE/Fire outputs or FARE/Fire relays on the brigade board. When disabled the associated LED will light steady. Pressing the button again will de-isolate the FARE/Fire outputs. The LED will flash when any of the FARE/Fire outputs are in fault



Pressing this button will disable the FWRE output relay on the Output board. If disabled the associated LED will also be illuminated. Pressing the button again will re-enable the FWRE relay. The LED will also be illuminated if the FWRE is in fault.



This button is used to disable or re-enable selected individual or groups of detectors, devices or zones.

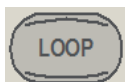

Press this button followed by a number to select the loop you wish to access.

e.g. LOOP 4.



After selecting the Loop number press this button to enter the device number for the device to be interrogated.



Press this button followed by a number e.g. ZONE 4 to select the required zone.



Press this button after selecting the Zone number or the Loop and Device numbers to display the state of the device.



Press and hold this “display” button while using the  buttons to adjust the LCD contrast (Access level 2 required)



These buttons are used to navigate around the panel’s menus and enter data.

If entering a descriptor, or some other data that contains characters as well as numbers, pressing the buttons multiple times will scroll through the available letters written on the button, in sequence. E.g. 1, A, B, C



Use this button to access a range of devices. E.g., 2 TO 7.



Press the ENTER button when using the panel, to enter data.



The CANCEL ENTRY button is used to delete data in a current field or return to the previously displayed menu.



Used to move the cursor back and forth when entering data in a field.



These buttons are used to move between fields when entering data and for adjusting the LCD contrast when the “Display” button is held on.

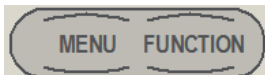

Pressing the MENU button will display the main menu on the LCD. Similarly pressing the FUNCTION button will display the function menu on the LCD.



NORMAL – Normal day to day operation. ENABLED – Access level 2.

Note the key can only be removed in the NORMAL position.

5.2 System Indicators

- FIRE** (Red LED) This LED will be illuminated steady if any fire alarms are present on the system.
- FAULT** (Yellow LED) This LED will be illuminated steady if there are any faults on the system, whether they are loop faults, module faults, device faults etc.
- DISABLED** (Yellow LED) The LED will light steady if any detectors, devices or zones in the system have been disabled or if an output relay has been de-activated. The display will show the conditions as per EN54 9.2 and 9.4.2
- POWER** (Green LED) This LED will be illuminated when power is connected to the FACP and switched on.
- POWER FAULT** (Yellow LED) This LED will be illuminated when there is a supply fault. The following conditions constitute a fault.
- Mains power is not available.
 - The output voltage is too low.
 - The output voltage is too high.
 - The battery is not connected properly or has failed.
- SYSTEM FAULT** (Yellow LED) This LED will be illuminated if the main system CPU is in fault
- EARTH FAULT** (Yellow LED) This LED will be illuminated if there is an earth fault (+ or -) on any of the signal cables of the system.
- ANC OUTPUT STATUS** (Yellow LED) The LED will be illuminated steady when the output is disabled and flashes when in fault
- TEST** (Yellow LED) This LED will be illuminated when the panel is in any of the test modes.
- FIRE OUTPUT ON** (Red LED) This LED is illuminated steady when there is an output configured as a Fire Output is turned on. Flashes when Fire Input On
- PRE-ALARM** (Red LED) This LED will be illuminated when a device/detector is in the pre-alarm state.
- DAY NIGHT ACTIVE** (Yellow LED) The LED is illuminated when the Day / Night facility has been enabled

6 Functions And Menus



IMPORTANT NOTE: *It is strongly recommended that all field programming changes be properly recorded.*

6.1 The Default LCD Display

In its normal state the **FireFinder PLUS** will display a screen similar to that shown below.

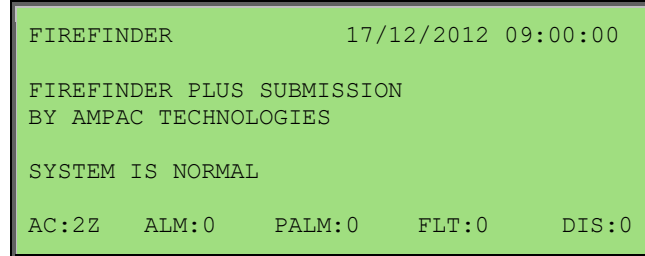





Figure 17: The Default LCD Display

This screen can be configured with the servicing company's name and phone number via a laptop or modem. The current date, time is set in the Function menu while system status is automatically displayed.

6.2 LCD Contrast

The Contrast can be adjusted using a combination of the  button the  and  buttons.

Keep the 'Display' button pressed while simultaneously pressing the '<' button to take the contrast down 1 level, the '>' to take up the contrast by 1 level, the '<<' to take the contrast down by 8 levels or the '>>' to take the contrast up by 8 levels.



Note: *This button combination will only work in access level 2 or higher.*

6.3 Accessing Functions and Menus

At Levels 2 and 3, access to the panel Functions are password protected.

A new panel has a pre-programmed password of **2222** for Level 2 and **3333** for Level 3.



Note: *Only Authorised Service Technicians / Engineers have the ability to change passwords.*



Note: *All menus are provided with screen prompts and a "Quick Reference Guide" (see Section 21) guides the operator through the operation of the FACP.*



From the **DEFAULT DISPLAY**, press **MENU** or **FUNCTION**. The **FUNCTION** menu is password protected (actually a pass-number as it can only contain numbers) to prevent unauthorised changes to the panel's configuration.

6.4 Function Menu and Access Levels

Three levels of ACCESS are available via separate passwords so that access to certain facilities can be restricted (such as the ability to enter new passwords).

- Level I: Allows access to indications and controls to investigate and respond to a fire or fault warning.
- Level II: In addition to the level I facilities, quiescent, fire alarm fault warning, disable and test conditions.
- Level III: In addition to the level II facilities, reconfigure specific data or control and maintain the panel in accordance with the manufacturers' specifications.
- Level IV: In an addition to level III trained and authorised by the manufacturer to repair or alter the firmware of a panel.

6.4.1 Forgotten Passwords

Follow the following process if a password has been forgotten or misplaced;

Entering 9999 into the password field;

1. Take note of the 4 digit password number displayed on the screen; then
2. Contact the local AMPAC office and quote the above number;
3. A temporary password will be issued and a new password can then be programmed into the FACP.

 **Note:** *The temporary password becomes invalid if 9999 is entered again or if the panel is re-powered after 9999 has been entered.*

7 The Main Menu

The **MAIN MENU** is accessed by pressing



```

MAIN MENU

0:ALARMS   1:STAGE 1 ALARMS   2:PRE-ALARMS
3:FAULTS   4:DISABLES         5:WALK TESTS
6:STATUS   7:TOOLS             8:SETUP
9:ABOUT
SELECT NO.
AC:2Z      ALM:0   PALM:0   FLT:0   DIS:0
  
```

Figure 18: The Main Menu (No Network)

Numbering System: ❶ denotes the menu structure number, ① denotes the sub-menu numbering, ① denotes a sub-menu within a sub-menu and ① denotes another sub-menu within a sub-menu

Pressing the appropriate number on the keypad while in the MAIN MENU the user can view any;

7.1 Alarms



Pressing ❶ Displays all Alarms present on the system.

```

ZONE:    1
Zone 1
STATUS:  ALARM
`DATE'  `TIME'

ZONE ALARM    1 OF    1
                                         DEVICE>
AC:2Z      ALM:0   PALM:0   FLT:0   DIS:0
  
```

Figure 19: The ALARMS display

Pressing the  will display the Device Information the screen, pressing the  will return it to Zone Information

7.2 Stage 1 Alarms



Pressing ❶ Displays all Stage 1 Alarms present on the system

```

ZONE:    1
Zone 1
STATUS:  STAGE 1 ALARM
`DATE'  `TIME'

ZONE STAGE 1 ALARM    1 OF    1
                                         DEVICE>
AC:2Z      ALM:0   PALM:0   FLT:0   DIS:0
  
```

Figure 20: The STAGE 1 ALARMS display

Pressing the  will display the Device Information the screen, pressing the  will return it to Zone Information

7.3 Pre-Alarms



Pressing **2** Displays all Pre-Alarms on the system

```

ZONE: 1
Zone 1
STATUS: PRE-ALARM
`DATE' `TIME'

ZONE PRE-ALARM 1 OF 1
                                         DEVICE>
AC:2Z   ALM:0   PALM:0   FLT:0   DIS:0
  
```

Figure 21: The PRE-ALARMS display

Pressing the  will display the Device Information the screen, pressing the  will return it to Zone Information

7.4 Faults

Pressing **3** Displays all Faults on the system

```

FAULT MENU

0:ZONE/DEVICE      1:LOOP      2:MODULE
3:P/SUPPLY        4:BRIGADE   5:TFAILS
6:SOUNDERS        7:ADD ONS   8:SYSTEM

SELECT NO.
AC:2Z   ALM:0   PALM:0   FLT:0   DIS:0
  
```

Figure 22: The Fault Menu display (no network)

```

FAULT MENU

0:ZONE/DEVICE      1:LOOP      2:MODULE
3:COMMS           4:P/SUPPLY   5:BRIGADE
6:TFAILS         7:SOUNDERS   8:ADD ONS
9:SYSTEM

SELECT NO.
AC:2Z   ALM:0   PALM:0   FLT:0   DIS:0
  
```



Figure 23: The Fault Menu display (Network configured)

```

ZONE: 1
Zone 1
STATUS: FAULT
`DATE' `TIME'

ZONE FAULT 1 OF 1
                                         DEVICE>
AC:2Z   ALM:0   PALM:0   FLT:0   DIS:0
  
```

Figure 24: The FAULTS display

Pressing the  will display the Device Information the screen, pressing the  will return it to Zone Information

7.5 Disables



Pressing **4** Displays all Disables on the system.

```

ZONE: 1
Zone 1
STATUS: DISABLE
`DATE' `TIME'

ZONE DISABLE      1 OF 1
                                     DEVICE>
AC:2Z    ALM:0    PALM:0    FLT:0    DIS:0
  
```

Figure 25: The DISABLES display

Pressing the  will display the Device Information the screen, pressing the  will return it to Zone Information

Note: If there are no alarms, pre-alarms, faults or disables, a message, e.g. 'NO ZONES OR DEVICES IN ALARM OR SOUNDERS OR ADDONS DISABLED', will be displayed for 1 to 2 seconds and then the display will return to the Main menu.

```

NO ZONES OR DEVICES OR
          SOUNDERS OR ADDONS DISABLED

AC:2Z    ALM:0    PALM:0    FLT:0    DIS:0
  
```

Figure 26: No Zone or Devices Sounders or Addons disabled screen

7.6 Walk Tests



Pressing **5** Displays all Walk Tests on the system

```

ZONE: 1
Zone 1
STATUS: WALK TEST

                                     TERMINATE<KEY 0>
ZONE WALK TEST      1 OF 1
                                     DEVICE>
AC:2Z    ALM:0    PALM:0    FLT:0    DIS:0
  
```

Figure 27: The WALK TEST display

Pressing the  will display the Device Information the screen, pressing the  will return it to Zone Information

7.7 Status

Pressing **6** Displays the Status of the system

```

STATUS MENU

0: LOOPS          1: MODULES      2: I/O
3: BRIGADE       4: SYSTEM       5: AVALUES
6: ADD ONS

SELECT NO.
AC: 2Z   ALM: 0   PALM: 0   FLT: 0   DIS: 0
  
```

Figure 28: The Status Menu (No networking)

```

STATUS MENU

0: LOOPS          1: MODULES      2: I/O
3: BRIGADE       4: NETWORK      5: SYSTEM
6: AVALUES       7: ADD ONS

SELECT NO.
AC: 2Z   ALM: 0   PALM: 0   FLT: 0   DIS: 0
  
```

Figure 29: The Status Menu (Networking)

From the STATUS MENU the status of system components and settings can be selected and displayed as listed below.



Note: Different screens are displayed for a system with and without networking.

Press

0 **Loops:** Enter the loop number and the LCD will display its status, e.g. normal, type of fault etc. The Loop current draw and noise levels will also be shown in panels that have Slave CPU software version V9.0 or higher

```

LOOP NO: 1

STATUS: NORMAL
CURRENT (mA) 0      NOISE (mA) 0

0: PRINT ALL DEVICES      1: PRINT TOTAL
SELECT NO.
AC: 2Z   ALM: 0   PALM: 0   FLT: 0   DIS: 0
  
```

Figure 30: Display Loop Status

1 **Modules:** Select the type of module, Slave **0** and P/S **1**

```

DISPLAY MODULE STATUS

0: SLAVE          1: POWER SUPPLY

SELECT NO.
AC: 2Z   ALM: 0   PALM: 0   FLT: 0   DIS: 0
  
```

Figure 31: The Display Module Status display

2 **I/O:** The LCD will display the status of an input or output in a panel or on a loop, Outputs **0** and Inputs **1**.

```

DISPLAY INPUT/OUTPUT STATUS

0:OUTPUTS          1:INPUTS

SELECT NO.
AC:2Z   ALM:0   PALM:0   FLT:0   DIS:0
  
```

Figure 32: The Display I/O Status display

```

DISPLAY OUTPUT STATUS

0:IN A PANEL       1:ON A LOOP

SELECT NO.
AC:2Z   ALM:0   PALM:0   FLT:0   DIS:0
  
```

Figure 33: The Display Output Status display

Once entered the LCD will then display a description of what that input or output does and its current state.

- ③ **Brigade:** Displays the Brigade Status

```

BRIGADE STATUS      (NP: 1)
NIC VERSION:  0.0.00.00
OUTPUT 1: (FIRE    ) OFF      /NORM
OUTPUT 2: (FAULT  ) OFF      /NORM
OUTPUT 3: (ALMDEV ) OFF      /NORM
OUTPUT 4: (ALMDEV ) OFF      /NORM
PRESS > FOR INPUTS/RELAYS/AUXS
AC:2Z   ALM:0   PALM:0   FLT:0   DIS:0
  
```

Figure 34: Display Brigade Status

- ④ **Network:** Displays Network Status.

 **Note:** This option is only available if the system configuration is networked.

Is pressed to gain access to NETWORK STATUS.

```

DISPLAY NETWORK STATUS
NIC VERSION:  0.0.00.00

0:NETWORK POINTS
1:REMOTE SLAVE MODULES
SELECT NO.

AC:2Z   ALM:0   PALM:0   FLT:0   DIS:0
  
```

Figure 35: Display Network Status

① Network Points:

Figure 36: Display Network Points

Network Points Screens are

- ① **STATUS:** Press, Select network point e.g. Loop Number
- ① **POWER SUPPLY:** Press to display Charger Volts, Battery Detected and Mains OK
- ② **BRIGADE:** Press to display Operational or Non-Operational

① **Remote Slave Modules:**

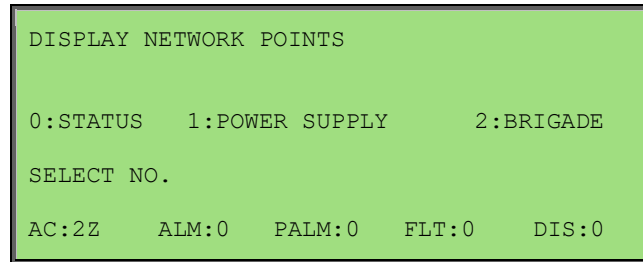
Select from Network Status Remote Slave Modules, then Module number.

```

Apollo Loop 1
TYPE:APOLLO      LOOP NO:1      VER: 6.1
NP:1             MOD:4          STAT:NORMAL
REMOTE MODULE   STATUS

AC:2Z    ALM:0    PALM:0    FLT:0    DIS:0
  
```

Figure 37: Display Remote Module Status



Note: The SYSTEM, AVALUES and ADD-ONS will increment by 1 if the network is configured

④/⑤ **SYSTEM:** Is pressed to access SYSTEM STATUS

```

SYSTEM STATUS
ALARMS:000 PRE-ALARMS:000  DISABLES:000
DEVICE FAULTS:00          MOD FAULTS:00
LOOP FAULTS:00           EXTRA DEVICES:00
WALK TEST:00             WDOG:00
APP: V 1.0   EN54
CONFIG:
AC:2Z    ALM:0    PALM:0    FLT:0    DIS:0
  
```

Figure 38: Display System Status

⑤/⑥ **AValues:** Is pressed to access AVALUES.

Select Loop Number and device number to show AVALUES

```

Loop 1      sensor 1

L1      S1      Z2
STAT: NORMAL
AVALUE:25  MODE:0      I:000      O:000

0:PRINT ENTRY
AC:2Z    ALM:0    PALM:0    FLT:0    DIS:0
  
```

Figure 39: Analogue Values

⑥/⑦ **ADD-ONS:** Is pressed to access MODULE status

```

DISPLAY ADD-ON MODULE STATUS

NODE: 000
MODULE (1-32):

SELECT ADD-ON MODULE NO. THEN ENTER KEY

AC:2Z    ALM:0    PALM:0    FLT:0    DIS:0
  
```

Figure 40: Add on Module status

7.8 Tools

Pressing ⑦ allows for the Testing of the following selected fields

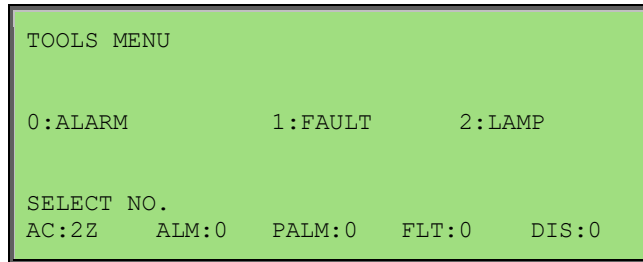

Figure 41: The TOOLS menu

Pressing ⑩ brings up a further detailed selection sub-menu for an Alarm tests.

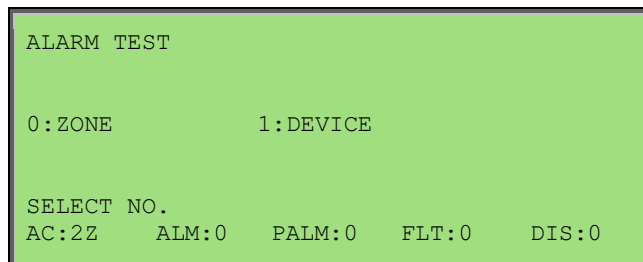

Figure 42: The ALARMS test menu

Pressing ⑪ brings up a further detailed selection sub-menu for a Fault tests.

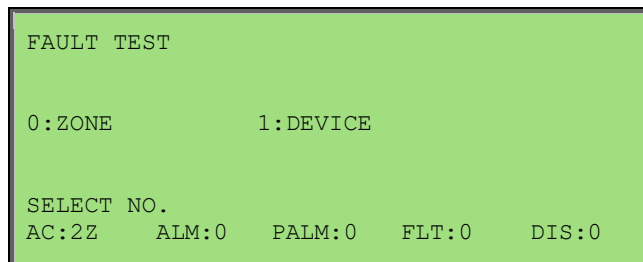

Figure 43: The FAULT test menu

Pressing ⑫ initiates a LAMP Test. Which will scroll thru and illuminate all LED's and LCD screen

7.9 Setup

Pressing ⑧ Displays the setup for sounders, Zone Delay and Printer

```

SETUP MENU

0: SOUNDER      1: ZONE DELAY      2: PRINTER

SELECT NO.
AC:2Z      ALM:0      PALM:0      FLT:0      DIS:0
  
```

Figure 44: The SETUP menu

Pressing ⑩ brings up a further detailed selection sub-menu for Sounder O/P's.

```

SOUNDER MENU

0: SOUNDER ENABLE      1: SOUNDER DISABLE
2: SOUNDER RE-TRIGGER (ON)
3: SOUNDER RE-TRIGGER (OFF)
CURRENT STATUS: ENABLE / RE-TRIGGER (ON)
SELECT NO.
AC:2Z      ALM:0      PALM:0      FLT:0      DIS:0
  
```

Figure 45: The SOUNDER menu

Pressing ② and ③ require access level 3.

Pressing ① brings up a further detailed selection sub-menu for Zone delays

```

ZONE DELAY MENU

0: ALL ZONE DELAY ON  1: ALL ZONE DELAY OFF

CURRENT STATUS: DELAY ON

SELECT NO.
AC:2Z      ALM:0      PALM:0      FLT:0      DIS:0
  
```

Figure 46: The ZONE DELAY menu

Pressing ② brings up a further detailed selection sub-menu for Printer

```

PRINTER MENU

0: GO OFF-LINE / GO ON-LINE

1: ALARM MODE ONLY

SELECT NO.
AC:2Z      ALM:0      PALM:0      FLT:0      DIS:0
  
```

Figure 47: The PRINTER menu

The GO OFF-LINE and GO ON-LINE is a toggle option

7.10 About

Pressing **9** Displays the panel's application software version number and the title information. Title information could be company name, contact information and so on.

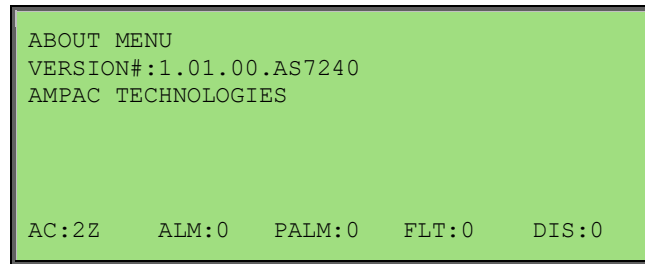

```
ABOUT MENU
VERSION#:1.01.00.AS7240
AMPAC TECHNOLOGIES

AC:2Z    ALM:0    PALM:0    FLT:0    DIS:0
```

Figure 48: The About menu

8 The Function Menu

The **FUNCTION MENU** is accessed by pressing  button.

A prompt will ask for a **PASSWORD** if the control panel is not currently active. Using the keypad key in the Level 2 or 3 **PASSWORD**.

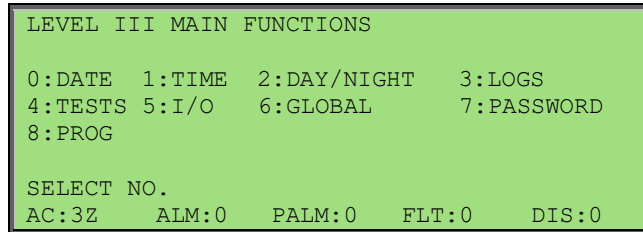



Figure 49: The Level II & III Functions Menu

8.1 Date

Press **0** To select the set **DATE SCREEN**. The prompt will ask for the date to be entered in this format, **DD/MM/YYYY** (EG 01/01/2011), key in and press . The screen will then return to the **MAIN FUNCTIONS MENU**.

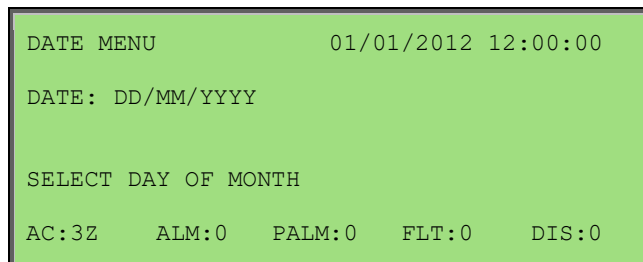



Figure 50: DATE Menu

8.2 Time

Press **1** To select the set **TIME SCREEN**. Then in the following format key in the time, **HH:MM** using the 24 hour mode. Press  and the screen will return to the **MAIN FUNCTIONS MENU**.

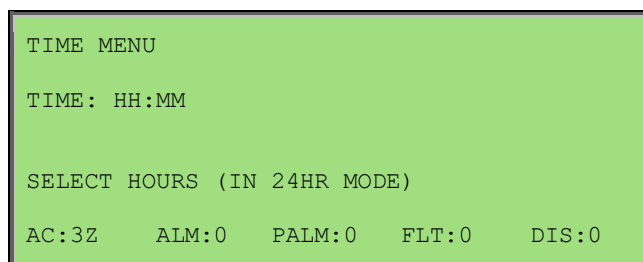

Figure 51: TIME Menu

8.3 Day/Night

Press ② The **DAY-NIGHT SETTINGS** screen will appear. Time entry is the same as setting the "Time" facility. Note this Function is available at Access Level 3 only.

Press ① To enter the **DAY ON** time.

Press ① To enter the **NIGHT ON** time.

Press ② To **ENABLE / DISABLE**

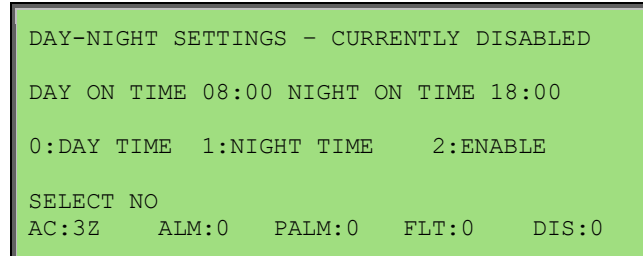

Figure 52: DAY-NIGHT SETTINGS Menu

For this Function to have control it must be **ENABLED** by press ② Re-pressing ② will toggle to **DISABLE**.

8.4 Logs

Press ③ to access the **EVENT LOG MENU** will be displayed.

The **LOGS MENU** allows the operator to select and view the events that have occurred.

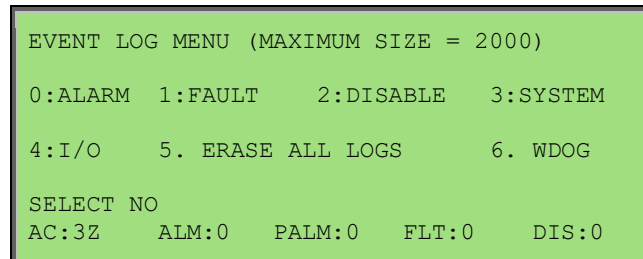
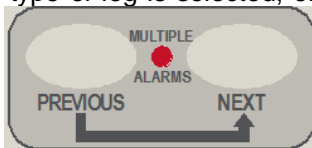

Figure 53: DAY-NIGHT SETTINGS Menu

Once the type of log is selected, e.g. **FAULT**, each entry can be viewed by stepping through them



using the buttons

Pressing ⑤ and ⑥ require access level 3.

The type of log, number and totals logged, date and time of the **ALARM**, **FAULT**, **DISABLE**, **SYSTEM** or **I/O** as well as device information will be displayed. The **SYSTEM** screen displays events and watchdog activity. From these screens the operator can select two other facilities, they are;

① **PRINT ENTRY** will print out the displayed information if a printer is installed, or

① **SHOW OPTIONS** allows the operator to select how the Logs are viewed.

① To **VIEW BY ENTRY NUMBER**, ① to **VIEW BY DATE** or ② to **PRINT MULTIPLE ENTRIES**. In each case the screen will ask for the appropriate information (**ENTRY NUMBER** or **DATE**) to be entered before the selected option will be displayed.

8.5 TESTS

Press **4** to access the TESTS menu. Note this is an Access Level 3 function only.

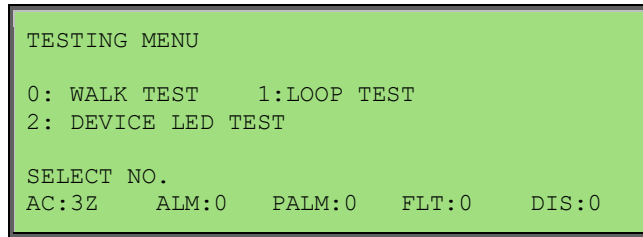

Figure 54: The Testing Menu

Press **0** Is pressed to initiate a **WALK TEST**:

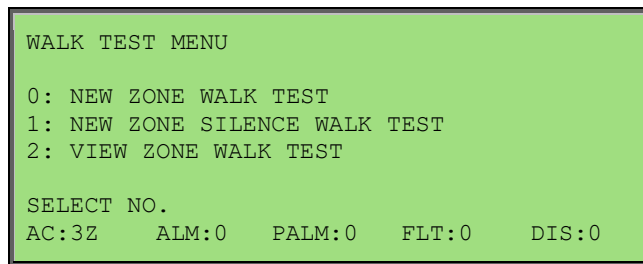

Figure 55: The Testing Menu



When in walk test the **TEST** indicator is on.

Press **1** **LOOP TEST** requires the operator to select a **LOOP** for **DIAGNOSTIC TESTING**

Entering the **LOOP number** and pressing **ENTER** will initiate the **DIAGNOSTIC TEST**.

Note: The LED's on the Brigade Board will indicate which leg is being tested.

The tests displayed are;

- TESTING SIDE A IDENTIFYING DEVICES on SIDE A, and
- TESTING SIDE B IDENTIFYING DEVICES on SIDE B.

Once the testing is completed the final screen will display the number of devices found and tested on the LOOP and a Reset is requested to return the system to normal.

Note: If the data is not entered within 2 minutes the screen will time out and return to the DEFAULT SCREEN.

Note: A Loop Test needs to be conducted after a short / open circuit has occurred, corrected and cleared to return the panel to its default Normal status otherwise the panel will display a loop fault.

Press **2** to initiate a **DEVICE LED TEST**:

This allows the user to turn on a device LED. Cancel out of the Device LED test screen will automatically turn off the device LED. If the device LED test screen is left on after 30 minutes the LED will turn off and the panel return to the Normal screen.

8.6 I/O

Press **5** To display the Manual I/O Control menu

```

MANUAL I/O CONTROL

0: INPUT          1 :OUTPUT

2: REMOVE ALL MANUAL CONTROL

SELECT NO.
AC:3Z    ALM:0    PALM:0    FLT:0    DIS:0
  
```

Figure 56: The Manual I/O Control Menu

Manual I/O control allows the technician to turn ON or OFF inputs and outputs off a device to facilitate testing or isolation of plant during maintenance. Removal of manual control returns control to the panel.

Press

① Input Selected:

```

MANUAL INPUT CONTROL

0:IN A PANEL      1 :ON A LOOP
2:IN LOCAL BRIGADE CARD
3:REMOVE ALL MANUAL INPUT CONTROL

SELECT NO.
AC:3Z    ALM:0    PALM:0    FLT:0    DIS:0
  
```

Figure 57: The Manual Input Control Menu

Press

① **IN A PANEL:** Enter the **I/O Controller number** then the **input number**. This will display the description for the input and its current state, you can then turn the input ON or OFF or remove manual control.

① **ON A LOOP:** Enter the **loop number**, the **device number** and the **input number**. This will display the description for the input and its current state, you can then turn the input ON or OFF or remove manual control.

② **IN LOCAL BRIGADE CARD:** Will bring up the list and status of the Brigade card Inputs. These can then be manually turned on and off with the exception of the MCP configured input

```

BRIGADE INPUT CONTROL

INPUT 1: (MCP      )      OFF /NORM
INPUT 2: (EVACUATE)      OFF /NORM
INPUT 3: (EXTERNAL FLT) OFF /NORM
INPUT 4: (RESET  )      OFF /NORM
SELECT INPUT NO. TO CHANGE STATE
AC:2Z    ALM:0    PALM:0    FLT:0    DIS:0
  
```

Figure 58: Brigade Input Controls

③ **Remove All Manual Input Control:** Will remove all manual input control.

① **Output Selected:** Same sequences as above for inputs but substitute outputs for inputs.

② **Remove All Manual Control Selected:** Globally removes all manual control.

8.7 Global (Network Panels)

Press **6** To display the Global Output Control menu

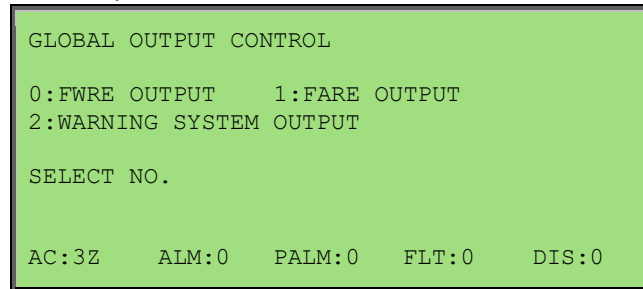

Figure 59: The Global Output Control Menu

Press

① FWRE OUTPUT:

Provides control to disable or enable the FWRE outputs. Press

① ENABLE

② DISABLE

① FARE OUTPUT:

Provides control to disable or enable the FARE outputs. Press

① ENABLE

② DISABLE

② WARNING SYSTEM OUTPUT:

Provides control to disable or enable the warning system outputs. Press

① ENABLE

② DISABLE

8.8 Passwords (Level III)

Press

⑦ While in the Main Functions menu and enter the Level III Password if in Access Level II or, if in Access Level III to display the Password Menu.

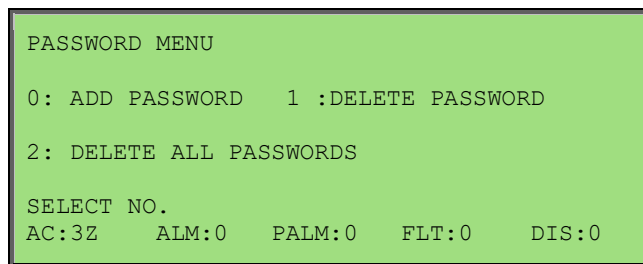





Figure 60: The Password Menu

① **Add Password:** Enter the new password, then press . The password is always a 4 digit number.

① **Delete Password:** Enter the password that you want to delete, then press .

② **Delete All Passwords:** This asks you to confirm that you want to delete all the passwords. Press  then  again.

③ **Zone / Device Mode:** This sets the mode in which Alarms, Faults, Pre-Alarms and Disables status information will be displayed. “Zone” is the default setting.

8.9 Programming

Press **8** To display the Level III Programming Menu.

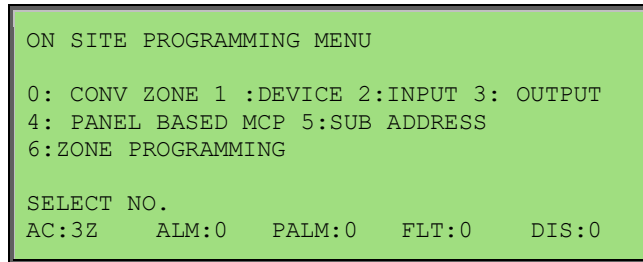

Figure 61: Programming Menu

8.9.1 Conv (Conventional) Zone

Press **0** **CONV ZONE:**



Key in the zone number and enter or change the description (**DESC**) by pressing buttons to move the flashing underline or cursor. The numeric buttons multiple times to access characters while at the same time using

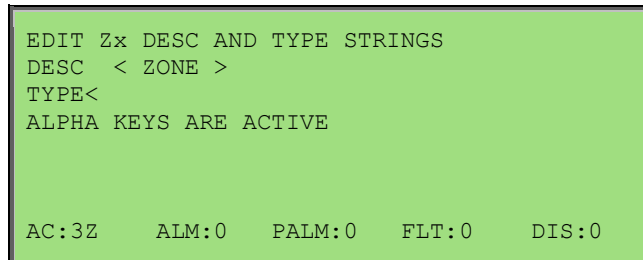



Figure 62: Zone Description & Type Programming

Press  to move to the **TYPE** field or edit the information.

Press  to move between fields use the reciprocal button

By going through all the fields a second screen can also be accessed to show the Output options.

Press  to step through these fields.

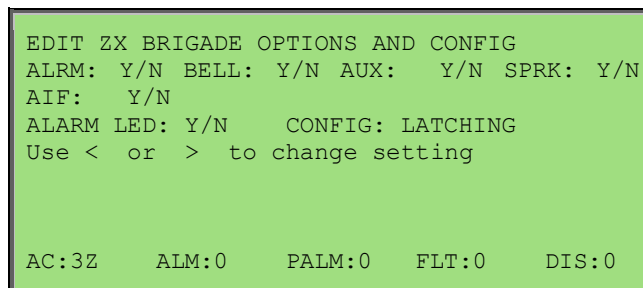



Figure 63: Brigade Options

The buttons  are used to set the Y/N field, which is the selected Zone that will activate the Brigade Options ALRM, BELL etc and Config.

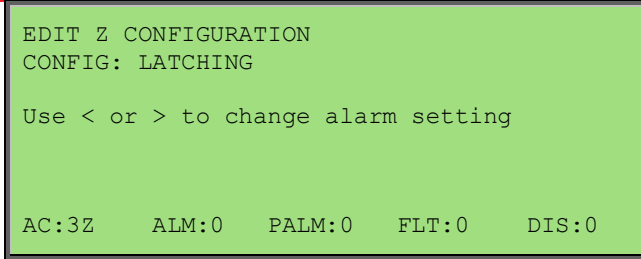

Figure 64: Zone Configuration Latching / Non-latching

Use or to change the setting

Configuration settings are Latching, Non-Latching, AVF, Self Reset (0 to 99 seconds). After setting the Configuration the ZONE I/O GROUPS are programmed.

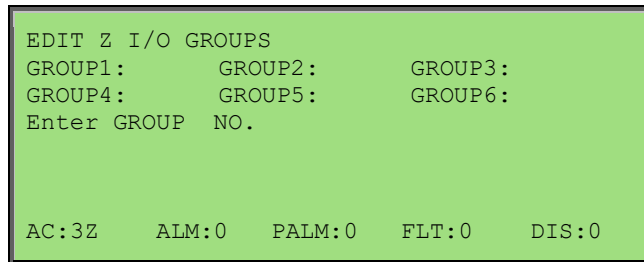

Figure 65: Zone I/O Groups

After scrolling through the groups and entering what I/O GROUPS will be turned on by what module/s or device/s in a zone/s the operator is prompted to press to confirm the entries and / or changes.

8.9.2 Device

Press ① DEVICE:



Use these buttons to **EDIT** and move through wording & numbering



Use these buttons to **MOVE** between fields i.e.: DESC & TYPE and next parameter

Enter the and number then scroll through the following screens.

Press or Press

① To **EDIT** or ① to **DELETE**

1. EDIT LxSx DESCRIPTION AND TYPE STRING. Edit then. Press
 e.g.: DESC Loop 1 Sensor 1
TYPE SMOKE

2. Allocate / Edit the Device to a Zone and set the device type then. Press
 e.g.: XP95 Photo, XP95 Heat etc-

3. Set /Edit and display the Output Configurations or options then. Press
 e.g.: Latching, AVF, Non-latching etc

4. Set / Edits and enables / disables the day/night settings then. Press



5. Allocates / Edits the Loop and Devices Groups.



After scrolling through the groups a prompt tells the operator to press to confirm the changes.

8.9.3 Input

Press ② **INPUT:**

By following the screen prompts as above Edit or Delete an **INPUT** in a panel or a loop.

Screen: PROGRAM MENU SELECTING AN INPUT

② IN A PANEL	① ON A LOOP
I/O MODULE	LOOP
Select I/O MODULE NO. then	Select LOOP NO. then
INPUT	DEVICE
Select I/P NO then	Select DEVICE NO. then
EDIT / DELETE DESC	INPUT
ALPHA BUTTONS ARE ACTIVE	Select INPUT NO. then button
	EDIT Lx Sx I/Px DESC STRING DESC

8.9.4 Output

Press ③ **OUTPUT:**

By following the screen prompts as above Add, Edit or Delete an output in a panel or on a loop.

8.9.5 Panel Based MCP

Press ④ to EDIT

8.9.6 Sub Address

Press ⑤ to EDIT

8.9.7 Watchdog

Press ⑥ This Function provides a counter to record any re-initialisation of the processor. If due to a software failure the panel is automatically reset then the counter will increment by 1. The maximum count is 99 after which the counter resets to 00. Pressing ① will reset the counter. When the panel is commissioned this counter **MUST** be reset to 0 as must be the **Events Logs**.

8.9.8 Zone programming

 **Note:** The panel Zone programming described below is in its basic form. For complex Zone programming that requires Dependency A, B, C or Delays to Outputs the Configmanager Plus programming application is required. Refer to MAN3127 Configmanager manual for details as specific Sounder Functions will be required to be configured for the Zone Activations to work as intended.

Press  to EDIT



Key in the zone number and select the  key.

Enter or change the description (**DESCR**) by pressing buttons to move the flashing underline or cursor. Press the numeric buttons multiple times to access characters.

```

EDIT ZONE: 1      DESC STRING
DESCR<MY ZONE 1 DESCRIPTION

ALPHA KEYS ARE ACTIVE

[USE>> TO EDIT NEXT FIELD]

AC:3Z      ALM:0      PALM:0      FLT:0      DIS:0
  
```

Figure 66: Zone Programming - Description

Press the  key to edit the next field (Day Night Settings).

```

EDIT ZONE: 1      DAY NIGHT SETTINGS
DAY_NIGHT ENABLE:      Y
DAY MODE SETTING:      A      TIMEOUT: 0
NIGHT MODE SETTING:    N      TIMEOUT: 0
[USE < OR > TO EDIT]
[USE << OR >> TO NAVIGATE]
AC:3Z      ALM:0      PALM:0      FLT:0      DIS:0
  
```

Figure 67: Zone Programming – Day/Night Setting 1

The keys  are used to set the:

- Y/N field for the "DAY_NIGHT ENABLE"
- A/B/C/D/N field for the "DAY MODE SETTING" and "NIGHT MODE SETTING" where "A, B, C" refers to "Dependency A, B, C" respectively, "D" refers to "Delay to Outputs" and "N" refers to "Normal" (i.e. no mode setting).

The numeric buttons are used to edit the TIMEOUT fields.

```

EDIT ZONE: 1      DAY NIGHT SETTINGS
                                DAY / NIGHT
MCP OVERRIDE:      N / N
DELAY ALARM DEVICE: N / N
DELAY FARE:         N / N
[USE < OR > TO EDIT]
[USE << OR >> TO NAVIGATE]
AC:3Z      ALM:0      PALM:0      FLT:0      DIS:0
  
```

Figure 68: Zone Programming – Day/Night Setting 2

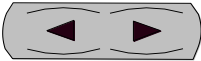
The keys  are used to set the Y/N field for the "MCP OVERRIDE, DELAY ALARM DEVICE, DELAY FARE".

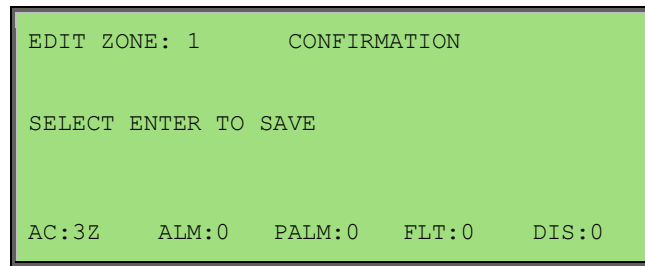



Figure 69: Zone Programming – Confirmation

Select the  key to confirm the changes.

8.9.9 Extra Devices Detected

The **FireFinder PLUS** LCD will indicate extra devices have been detected by displaying the screen below and the FAULT LED will be illuminated.

```

FIREFINDER                26/2/2007 08:05:45
EXTRA DEVICES DETECTED
GOTO PROGRAMMING MENU TO RESOLVE
SYSTEM IS NOT NORMAL

AC:3Z    ALM:0    PALM:0    FLT:0    DIS:0
  
```

Figure 70: Resolving Extra Modules and Devices

To resolve select **FUNCTION**, enter **PASSWORD**, press **6** and the screen below will appear

```

PROGRAMMING MENU
0: RESOLVE EXTRA MODULES AND DEVICES
1: ON SITE PROGRAMMING
SELECT NO.

AC:3Z    ALM:0    PALM:0    FLT:0    DIS:0
  
```

Figure 71: Added Module or Device

Select **0** (Selecting **1** presents the PROGRAMMING MENU) then **0** or **1** (as seen below) then ENTER to ADD the module or device to the configuration, or skip to resolve the changes manually in the Programming Menu.

```

0: ADD EXTRA MODULES  1: ADD EXTRA DEVICES
2: DEVICE TYPE MISMATCH 3: MODE MISMATCH
SELECT NO.

AC:3Z    ALM:0    PALM:0    FLT:0    DIS:0
  
```

Figure 72: Resolving Extra Modules or Devices

8.9.10 Mismatch Detected

If a mismatch is detected the Normal Default Screen will change to that shown below. Go to the Programming Menu and select either **0** *Resolve Extra Modules and Devices* then **2**

(*Device Type*) or **3** (*Mode*) to resolve the mismatch, OR On Site Programming to resolve manually.

```

Loop 1 Sensor 1
L1 S6 Z1 STAT: TYPE MISMATCH

ZONE FAULTS 1 of 1
  
```

Figure 73: Resolving a Mismatch

Self Learn is enabled / disabled in the EEPROM programming. If enabled **FireFinder PLUS** has the ability to detect extra or missing modules or devices, (that is devices or modules that have been added or removed) or there has been a change of the type of module or device.



Note: If a change does occur the FACP will take 30seconds to register the event on the LCD and illuminate the FAULT LED.

9 Incoming Fire Alarm Signal

- Will operate the red common LED fire indicator  **FIRE**
- Will display location of fire alarm origin on the LCD
- Will activate programmed Fire and Alarm outputs.
- Will activate the internal FACP buzzer.
- Will activate any ancillary equipment so programmed.
- Will abort any test in progress.

The LCD will always display the first fire alarm signal received in the top section of the LCD. The lower section of the LCD will also permanently display the most recent zone in alarm.

```

FIRST ALARM: L1 D1 Z1           15:31
D.DSC:Loop 1 Sensor 1
Z.DCS:Zone 1
LAST ALARM: L4 D49 Z5          15:31
D.DSC:Loop 4 Sensor 49
Z.DCS:Zone 5 Depend C
PRESS PREVIOUS/NEXT TO VIEW OTHER ALARMS
AC:2Z   ALM:5   PALM:0   FLT:0   DIS:0
  
```

Figure 74: LCD Screen with 5 Devices in Alarm

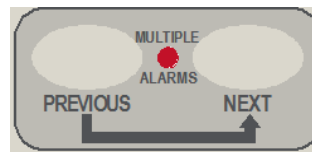

If more than 2 alarms are present use the  buttons to scroll through the suppressed devices/zones.

After 30 seconds if no button is pressed the top section of the display will revert to displaying the first zone in alarm.





Note: To view faults or disablements in the Fire alarm condition the Menu button must be used.

10 Accessing and Managing a Device or Zone

Functionality in this section requires Access level 2 or higher.

10.1 Displaying a Device

To display the status of a particular device press the  button, then enter the loop number

Next press  and enter the device number, then press .



The LCD will display the device status as follow:

```

Device Description                               Dev Type
L1 D1 Z1                                         POOL1
STATUS: NORMAL

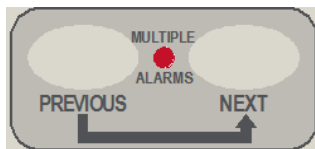
XP95 PHOTO
AC:2Z     ALM:0     PALM:0     FLT:0     DIS:0
  
```



The   buttons can then be used to scroll through all the devices.

10.2 Disabling a Device

Press the  then enter Loop number, press  then enter device number.

```



FIREFINDER           17/10/2013 09:00:00

LOOP:1  DEVICE:1

SELECT DEVICE NO. THEN TO OR DISPLAY OR
ZONE/DEVICE DISABLE/ENABLE KEY

AC:2Z  ALM:0  PALM:0  FLT:0  DIS:0
  
```

Next press the  to disable the single device or alternatively press the

 button select a range of devices to disable followed by the  button.

If the device is in a Zone that has more than one device in it then the LCD will display a partial Zone disablement as follows:

```

ZONE: 2
ZONE DESCRIPTION
STATUS:PARTIAL DISABLE
17/01/2013 02:26:13

ZONE PARTIAL DISABLE           1 OF 1
                                DEVICE>
AC:2Z  ALM:0  PALM:0  FLT:0  DIS:0
  
```

To view the disable device the  button should be pressed and the LCD will show the following:

```
L1 D4 Z2                                OPT/P001
DEVICE DESCRIPTION
STATUS: NORMAL                          /DISB
17/01/2013 02:26:13

DEVICE DISABLE          1 OF 1
                                ZONE<
AC:2Z   ALM:0   PALM:0   FLT:0   DIS:1
```

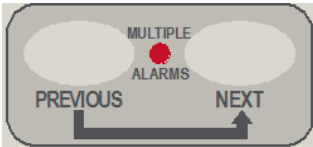

The  buttons can then be used to scroll through all the disabled devices.

To re-enable the devices the steps above will apply.

10.3 Displaying a Zone

To display the status of a particular Zone press the  button, then enter the zone number

Next press



The LCD displays the status of the first device that is in the selected Zone

```
Device Description                       Dev Type
L1 D1 Z1                                POOL
STATUS: NORMAL

AC:2Z   ALM:0   PALM:0   FLT:0   DIS:0
```

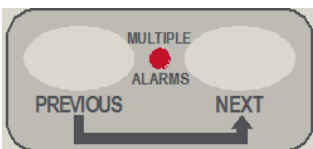

The  buttons can then be used to scroll through all the other devices and zones.

10.4 Disabling a Zone

Press



```
FIREFINDER          17/12/2012 09:00:00
ZONE: _____
SELECT ZONE NO. THEN TO OR DISPLAY OR
DEVICE DISABLE/ENABLE KEY
AC:2Z   ALM:0   PALM:0   FLT:0   DIS:0
```



then Press  for Zone 1 selection. Now Press the



and

the following will be displayed on the LCD:

```

FIREFINDER          17/12/2012 09:00:00

ZONE:1
0:FULL ENABLE      1:FULL DISABLE
2:SET AUTOMATIC ENABLE TIMER & DISABLE

AC:2Z  ALM:0  PALM:0  FLT:0  DIS:0
  
```



Select  to "Full Disable" the Zone. The applicable Zone indicator (if fitted) will be ON Amber and the LCD will display the following:

```

ZONE: 1
ZONE DESCRIPTION
STATUS:DISABLE
17/01/2013 02:26:13

ZONE DISABLE          1 OF 1
                        DEVICE>
AC:2Z  ALM:0  PALM:0  FLT:0  DIS:1
  
```



To re-enable the Zone Press , select  for Zone 1, then press then press option "0" to "Full Enable" the Zone.

10.5 Zone Disable Timer



Note: This function is contrary to the requirements of EN54-2. An EN54-2 compliant system requires all Disablements to be re-enabled by a manual operation (Refer EN54-2 clause 9.1.2)

To apply a Disable timer to a Zone (up to a maximum of 12 hours) that will automatically re-enable the Zone after a set time period apply the following:



Press  then select the Zone number to apply the Disable timer on.



Then press the  and the following will be displayed on the LCD:

```

FIREFINDER          17/12/2012 09:00:00

ZONE:1
0:FULL ENABLE      1:FULL DISABLE
2:SET AUTOMATIC ENABLE TIMER & DISABLE

AC:2Z  ALM:0  PALM:0  FLT:0  DIS:0
  
```

Select option "2: SET AUTOMATIC ENABLE TIMER & DISABLE" to bring up the following screen

```

FIREFINDER          17/12/2012 09:00:00

SET TIMER: HH:MM

SET HOURS, MINUTES THEN ENTER TO SAVE

AC:2Z   ALM:0   PALM:0   FLT:0   DIS:0
  
```

Enter the required amount of hours and minutes the Zone is required to be disabled the press enter to save.

The applicable Zone indicator will turn ON Amber to indicate the Disabled condition.

The "General" Disabled indicator will be ON and the LCD will display the following:

```

ZONE: 1
ZONE DESCRIPTION
STATUS:DISABLE
17/01/2013 02:26:13      REMAINS: 00:05

ZONE DISABLE              1 OF 1
                           DEVICE>
AC:2Z   ALM:0   PALM:0   FLT:0   DIS:1
  
```

Note the remaining count down time on the fourth line.

When the timer reaches 3 minutes remaining the Buzzer will beep every 10 seconds and the General Disable LED will flash to provide attention that the re-enablement is imminent.

Once the timer reaches 00:00 the Zone will automatically be re-enabled.

To extend the Timer the steps above should be followed.

11 IMO General / Muster Alarm

The FireFinder Plus allows for monitored outputs on the Brigade Board and Loop Sounders to be configured to operate as a General / Muster Alarm.



Note: The General alarm sequence consists of 7 short blasts of the sounders followed by 1 long blast

Short blast duration = 1 sec

Long blast duration = 7secs

Off period between blasts = 1 sec

When signalled the alarm will continue to repeat the sequence until the Fire panel is Reset.

The General/Muster Alarm has a higher priority over any Fire alarms by default.



The Evacuate button can also be configured to operate as an initiating point for the General/muster alarm.

For configuring and programming the output, sounders, evacuate button and priority the ConfigManager Programming software is required (refer Manual MAN3127)

12 Modem / Programming / Debug Interfacing

The modem I/O port is a Dual DB9 connector (CN8 situated on the lower left hand corner of the Main Board BRD86MBA) that is normally used for programming of the FACP via the serial port of a PC or Laptop. There is also a USB connector (CN25) provided to allow programming of the FACP from a USB port of a PC. The Controller also has the required hand shaking to support connection to a Modem, thus allowing the FACP to be programmed from a remote site that has an established telephone connection. This allows the system software to be upgraded by simply transmitting a file via the serial port of the PC or Modem external to the FACP. Diagnostic facilities are also available via the same connection.

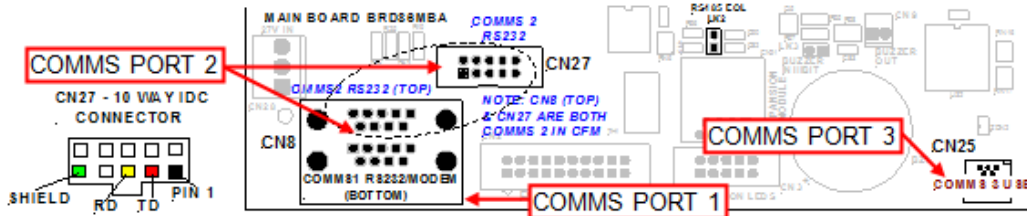

Figure 75: DB9 Connector CN8 as Mounted on the Main Board

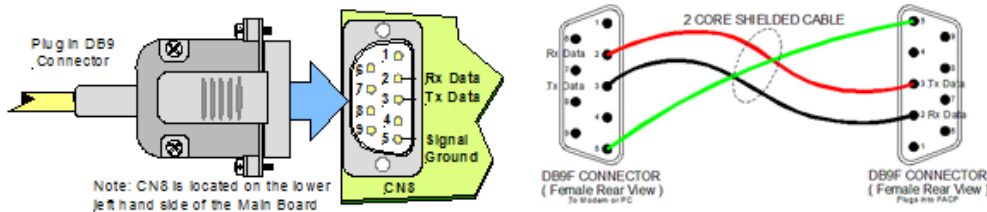

Figure 76: Modem / Programming / Debug Cabling



Figure 77: USB cable Type A Male Plug - Type B 5-Pin Mini Plug

Note: Debug/Notebook cables are available from AMPAC

Note: the DB9F to DB9F cable is not sensitive to which end is plugged in to the **FireFinder PLUS** or serial port of the PC or vice versa.

The connections between the PC/Modem and the panel are crossed. i.e. TD connects to RD.

Make sure the **ConfigManagerPlus** program is set to use the port you have connected the cable to and set up the configuration as follows:

Bits per second:	115200
Data bits:	8
Parity:	None
Stop bits:	1
Flow Control:	None

13 Expanding the FACP with Compatible FireFinder PLUS Boards

13.1 Ancillary Services

The FACP has been designed such that detectors and/or call points, in addition to giving an alarm and calling the fire brigade, will close or open circuits of ancillary services by means of relays or similar devices.

Examples of these services are:

- Actuation of fixed fire-extinguishing systems
- Closing of windows, smoke and fire doors
- Control of ventilating systems
- Covering of tanks containing flammable liquids and controlling their valves to isolate the contents from direct contact with the fire, etc.

To facilitate safe maintenance of these services an option is available that allows for the isolation and visual indication of the disablement of ancillary services that does not affect the normal operation of the fire alarm system.

To ensure power to the fire alarm system is not prejudiced in any way, power for the ancillary services must be included in the calculation of the power supply and battery capacity.

13.2 Compatible FireFinder PLUS Boards

Add- On Module / Board	Max No
Brigade Board *	1 Per Controller
8 Zone Conventional Card *	15 per Controller
32 Zone Alarm Mimic Card *	15 per Controller
8 Way Relay Board **	15 per Controller
16 Way Input Board **	15 per Controller
High Level Interface Expander **	3 per Controller
8 Way Sounder Board **	15 per Controller
Expansion Board **	1 per Controller
Network Interface Card **	1 per Controller
Apollo / Dual Loop Termination Board *	8 Per Controller

 **Note:** The Max Numbers of modules/boards that can be installed and configured within the FACP depends on the cabinet size and the number of Panels in the System.

 **Note:** * denotes LPCB approved modules. ** denotes modules that may operate or function outside the requirements of EN54-2.

 **Note:** Refer to individual Product datasheets and installation guides for complete details.

13.3 8 Zone Conventional Board

This board (BRD43Ezc) has 8 conventional zones. Up to 999 zones max may be configured.

The zones may be used in panel programming and Input / Output programming.

The end of line type used for the board is configurable to be any one of the following:

- 3k3 resistor
- 10uF bipolar capacitor (EN54 Default)
- 4k7 resistor
- 6k8 resistor
- 10k resistor

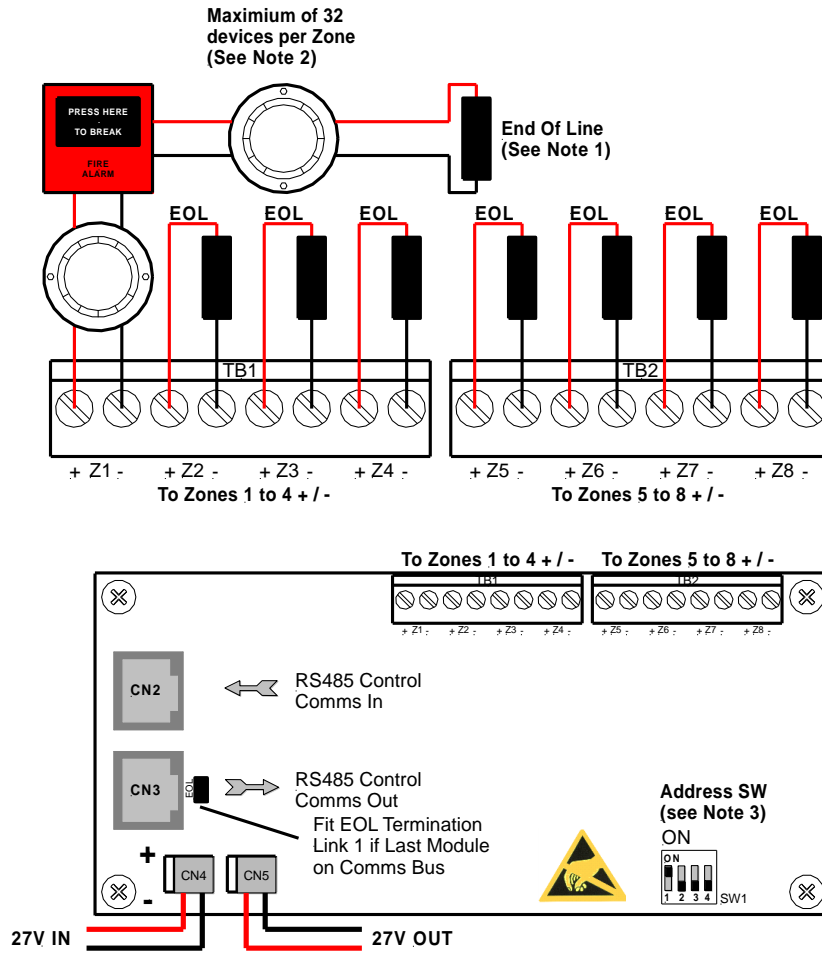

Figure 78: 8 Zone Conventional Board

Connections

Terminal/s	Function
TB1 to 2	ZONE + ZONE -
	Zones 1 to 8

Note 1: Each Zone circuit **MUST** be terminated with either a 3K3, 4K7, 6K8, 10K Ohm resistor or 10uF 50V Bi-Polar Capacitor EOL

Note 2: If Diode Bases are used **ONLY** the 10uF CAP can be used.

Note 3: See Section 19 for Addressing Details (SW1)

13.4 32 Zone Alarm Mimic Card

Each card (BRD43ZAMC) has 32 bi-coloured LED's which can be used to display the status of up to 32 Zones. The zone numbers assigned to each LED are configurable and the LED's will operate in the following manner for the respective zone statuses:

ZONE STATUS	LED STATE	LED COLOUR
FIRE	ON STEADY	RED
DEPENDENCY B	FLASH	RED
DISABLED	ON STEADY	YELLOW
FAULT	FLASH	YELLOW
ALL OTHER	OFF	n/a

The card will also respond to a lamp test when instigated on the panel to which it is connected.

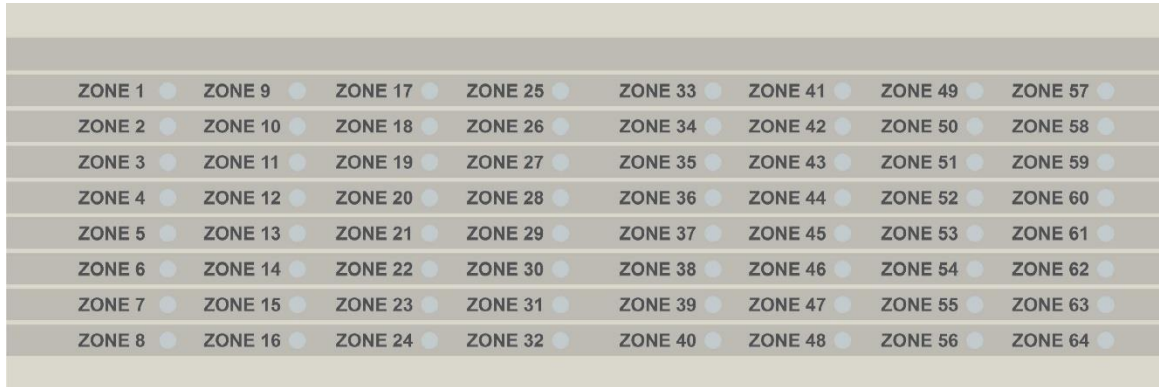

Figure 79: 64 Zone Indicator Decal

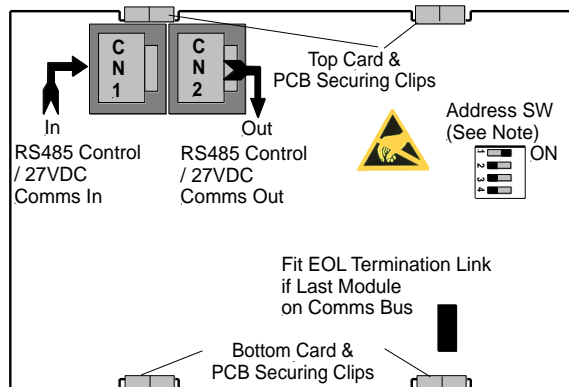

Figure 80: Zone Alarm Mimic Card Rear View showing connectors and Address Switch

Note: See Section 19 for Addressing Details (SW1)

13.5 16 Way Input Board

The 16 Way Input Board (BRD25SIP) makes provision for 16 voltage free contacts to be terminated to 16 optically coupled inputs. Its application is primarily for the monitoring of controlled ancillary equipment or to initiate an action / event due to a change of state from what is accepted as the norm.

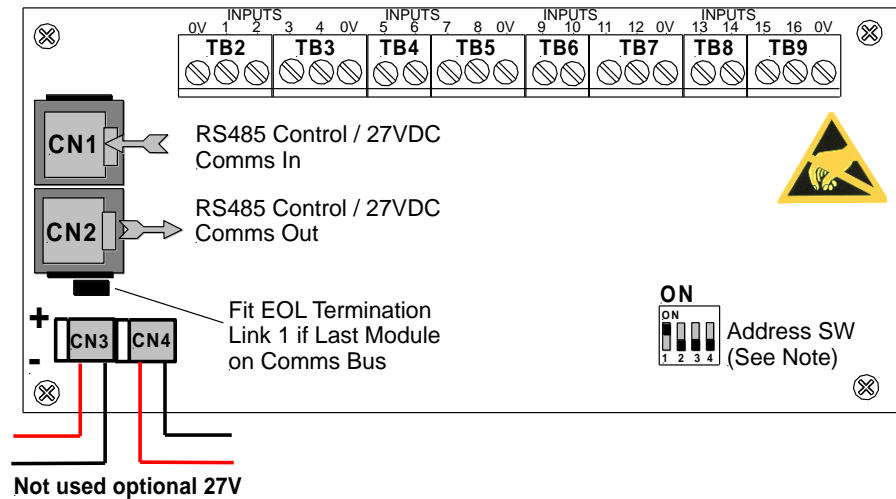
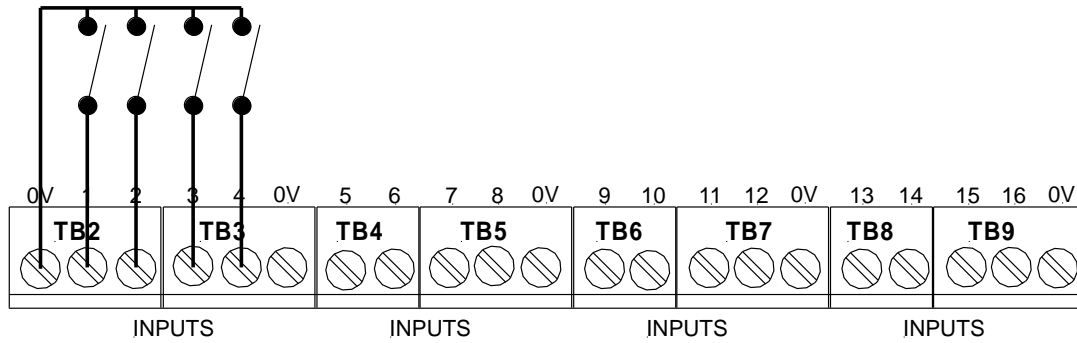

Figure 81: Typical Input Wiring and Board Layout Front View showing connectors and Address Switch

Connections

Terminal/s	Function
TB2 to 9	Taking note of the Common 0v terminals connect the voltage free contacts as shown above. Inputs 1 to 16

Note: See Section 19 for Addressing Details (SW1)

13.6 8 Way Relay Board

The Relay Board (BRD25EWRB) provides 8 programmable relays with 30VDC 1 Amp voltage free change over contacts for control or monitoring purposes and comes fitted for internal or external FACP use.

The functionality and programming of the relays is similar to the relays on the main board of the FACP. By default the relays default to Common Alarm functionality.

All terminal points are protected.

The board switches the relays as determined by the panel. The relays can be controlled by:

- Zones Alarm
- Group Alarm
- Device Alarm
- Internal Output
- Panel Output
- Loop Output
- Panel Input
- Loop Input
- Reset – relay is activated for 3 seconds when reset depressed

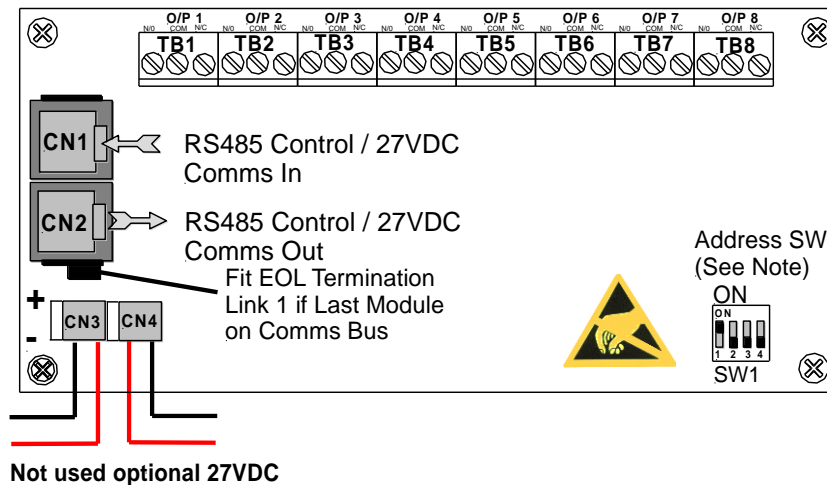
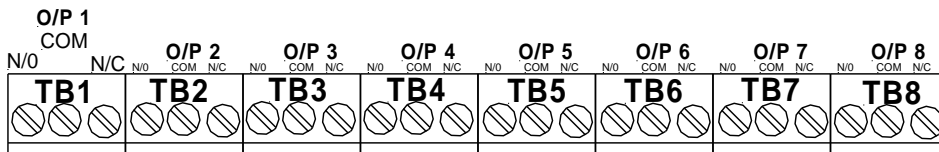
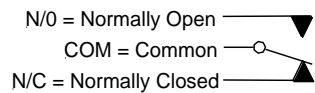

Figure 82: Internal 8 Way Relay Board Front View showing connectors and Address Switch

Relay Connections

Terminal/s	Function
TB1 to 8	N/O = Normally Open, C = Common N/C = Normally Closed

Relay 1 to 8

Note: See Section 19 or Addressing Details (SW1)

13.7 8 Way Sounder Board

The Sounder Board (BRD25SOP) expands the number of sounders that can be used on an FACP by 8. Each output is of a solid state design, rated at 24VDC / 750mA and requires a 10KΩ End of Line (EOL) resistor regardless of whether or not a sounder is wired to the circuit.

The sounder board will switch ON the sounders as configured (output off, continuous or pulsed) at the FACP and supervise the sounders for their open circuit, short circuit & line fault conditions.

Note: Sounder polarity MUST be observed.

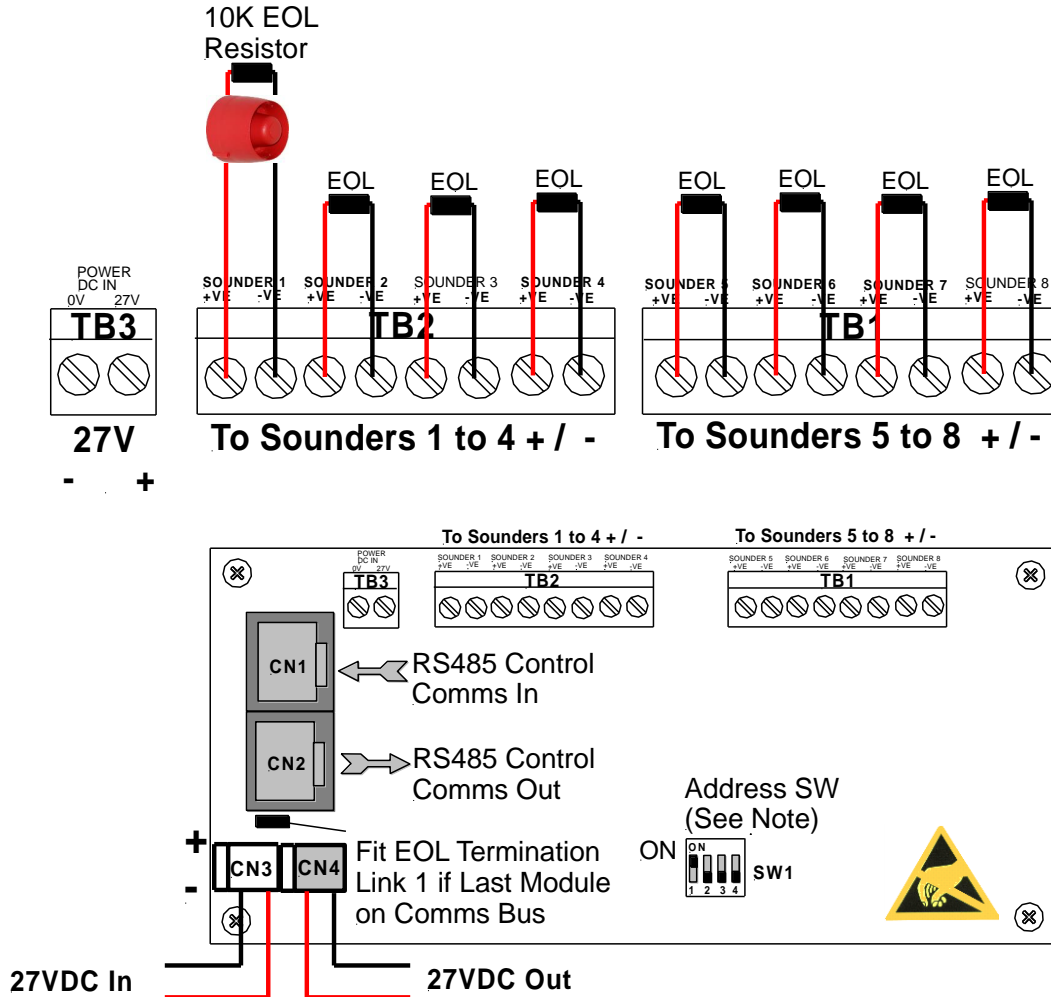

Figure 83: 8 Way Sounder Board Front View showing connectors and Address Switch

Maximum Current per Output: 750mA.

A +27VDC external power supply feed is required

In addition filtering and protection devices are used to reject transients.

Connections

Terminal/s	Function	
TB1 to 2	+ve -ve	Sounder 1 to 8
TB3	0V 27V	Power DC IN

Note: See Section 19 for Addressing Details (SW1)

14 Expanding the System Through Networking

Expanding the system can be achieved in various ways and requires the use of boards specifically designed for communications purposes and boards that actually expand the system.

14.1 Networking

When FACP's are connected to each other they form a "NETWORK". Individual FACP's in the Network are referred to as NODES. The Network as defined by the limitations of the installation can consist of a number of Nodes, the number of Nodes being dependant on the configuration of each Node. Typically an entire Network could consist of 60 Slave CPU's connected to loops and or input / output devices spread over several nodes. The Network is Peer to Peer with the entire system configuration being stored at each Node. The system is then programmed so that information can be made invisible to particular Nodes or visible to all Nodes. Likewise system commands can be global or restricted to specific parts of the network.

The entire system can be programmed from any Node in the Network and is connected as a data loop which provides redundancy should there be a single cabling fault.

(i) IMPORTANT

While it is important that proper documentation is kept and maintained for any installation it becomes even more important as a system develops into the larger types described above.

14.2 Network Interface Card

The Network Interface Board provides the RS485 communication buses via CN18 on the Main Controller (Loop Comms) to allow the networking of multiple panels in different combinations, e.g. from Data Gathering Panels (DGP) to Peer to Peer panels.

The Bias SW2 defaults to ON. SW2 is only switched to OFF when direct connecting the network to external devices such as Optical Fibre Modems.

The Isolate SW3 Allows the network node to be isolated from the network

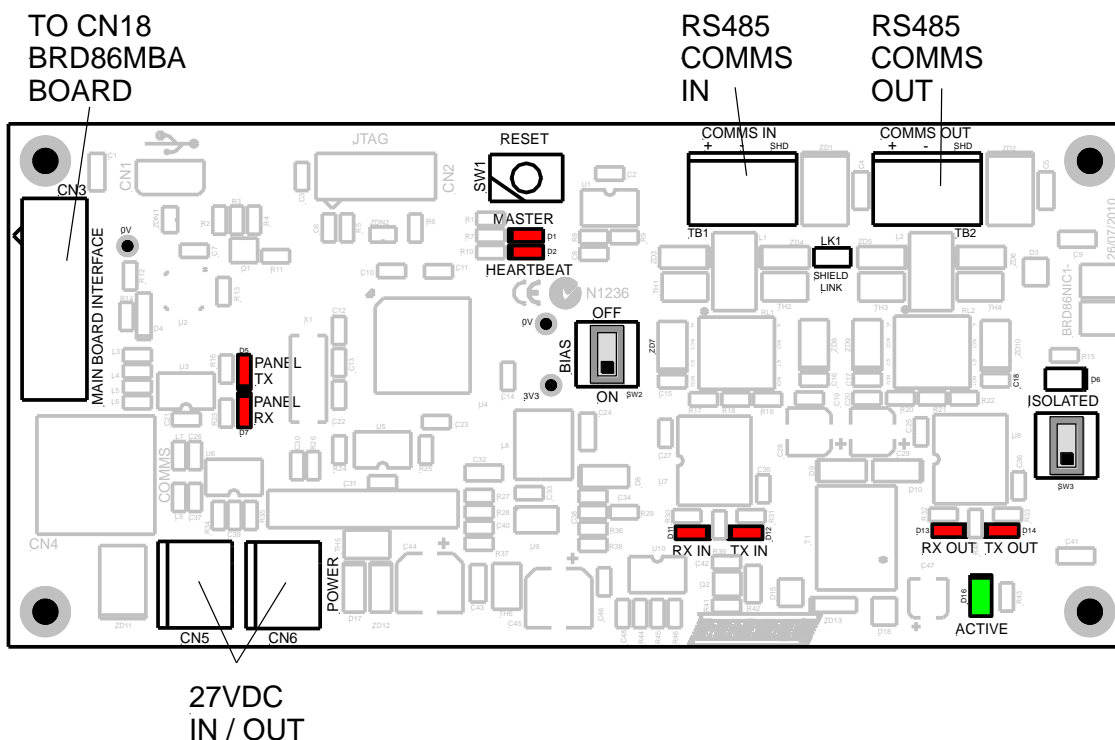

Figure 84: Network Interface Board Layout

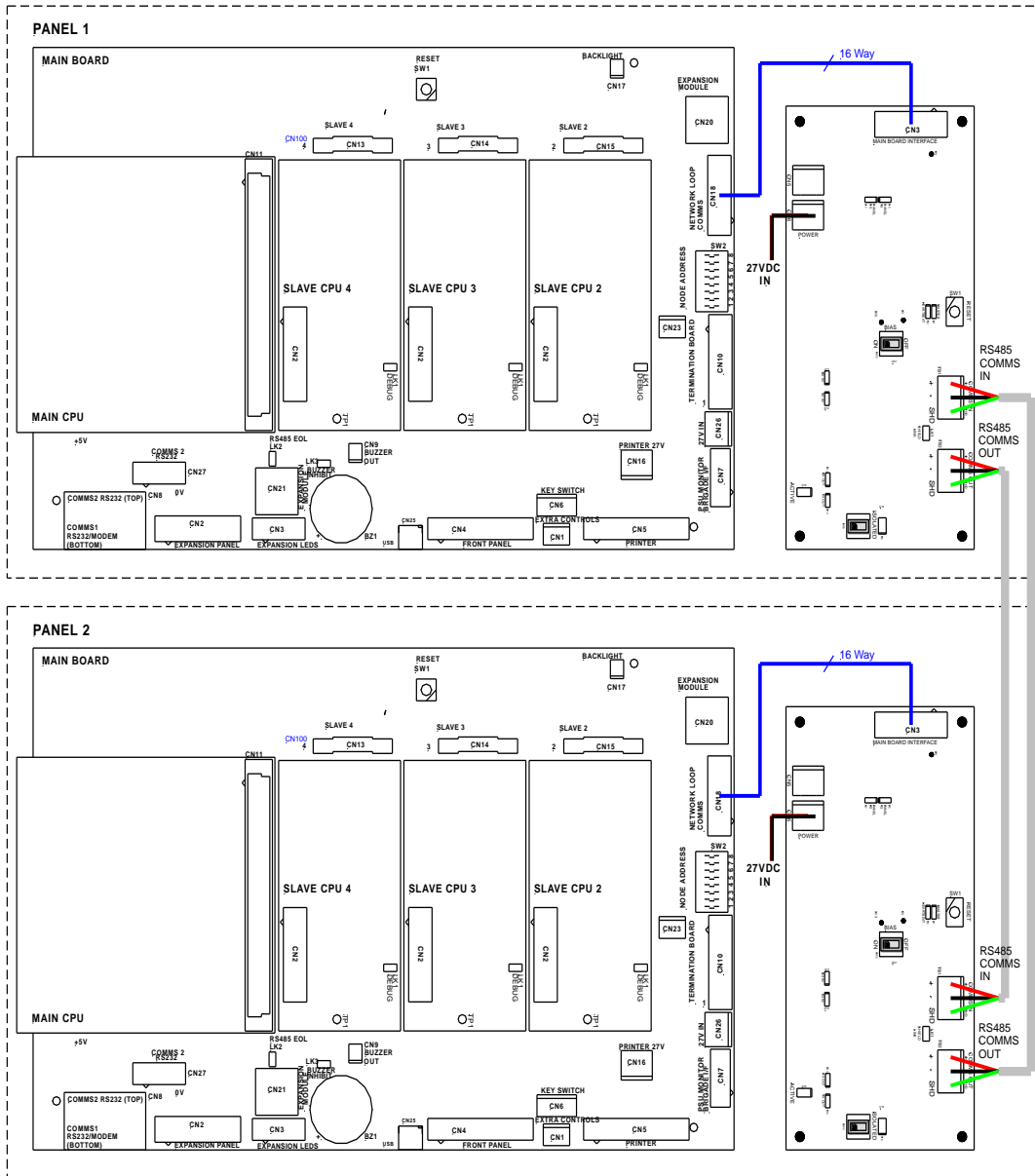

Figure 85: Basic 2 node system using a Network Interface card

15 High Level Interfacing

The High Level Interface board (BRD43HLI) provides RS232, RS485 and RS422 communications for interfacing to various external systems.

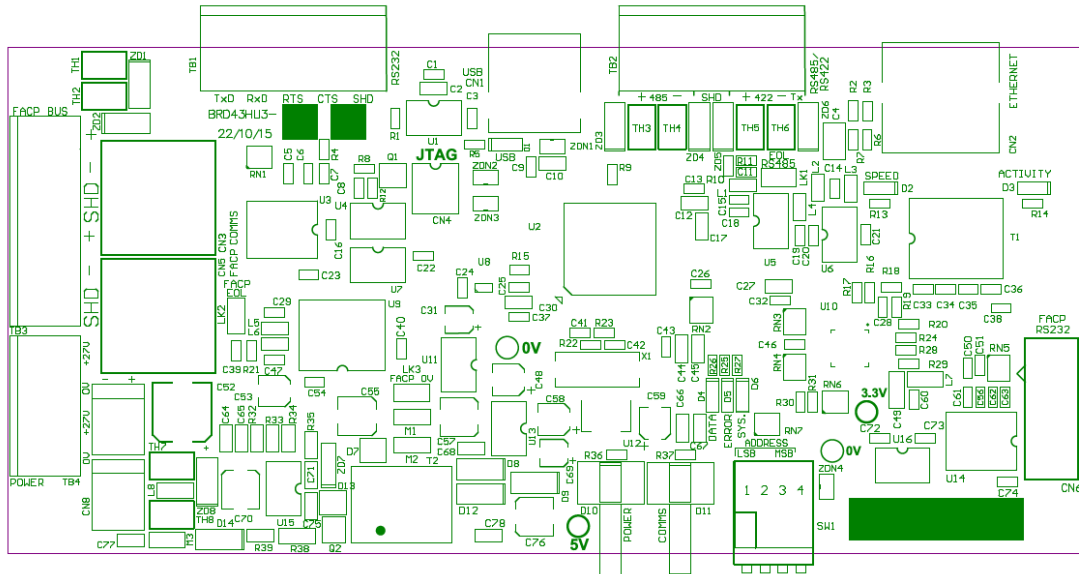

Figure 86: High Level Interface Expander PCB Layout

15.1 HLI

RS232 or RS485

Text based communication. Configurable attributes are: logical output, physical output, alarm output, pre-alarm output, fault output, isolate output and descriptors

15.2 SmartView

RS232 or RS422

SmartView is an extensible web-based, client server application whose primary role is dedicated to the monitoring and reporting of Ampac's fire detection system events. SmartView provides clear and precise alarm information using graphical and text formats.

15.3 MODBUS interface

RS232 or RS485

15.4 VDR interface

RS232, RS485 or RS422

Allows the fire control and indicating equipment to be connected to ships voyage data recorders (VDR), so that information from the fire detection system is recorded.

Converts standard FireFinder Plus Fire Control Panel messages to NMEA 0183 Standards compliant strings

Example: Fire, zone 01 on panel 0 (master)

```
$FRIR,S,FD,P0,01,A,V,Fire Zone 01*41<CR><LF>
```

16 Certification Information

The *FireFinder Plus* is designed and manufactured by:

AMPAC TECHNOLOGIES PTY LTD

7 Ledger Rd

Balcatta

WA 6021

Western Australia

PH: 61-8-9242 3333

FAX: 61-8-9242 3334



Manufactured to: _____

Certificate of Compliance Number: _____

Equipment Serial Number: _____

Date of Manufacture: _____

17 Maintenance and Troubleshooting Chart

17.1 Maintenance

The **FireFinder PLUS** FACP should be maintained so as to comply with all standards / regulations applicable to the country and location it has been installed. Failure to do so could put at risk compliance and the integrity of the system. As a minimum it is recommended the following be used as a guide to periodic maintenance especially if there is an absence of standards regulations.

General

To implement a site maintenance regime, responsibilities should be established by responsible persons, training implemented if required, maintenance delegates appointed and all outcomes clearly communicated to all parties.

Daily Operations (operator level)

- The delegated operator checks for normal operation
- If any faults are detected, record them in an established "Site Log Book" and report them to the assigned body.
- Ensure all faults are signed off as they are resolved and follow up on those that are still outstanding.

Monthly Operations (operator level)

- In addition to Daily Operational checks
- Visually inspect in and around the panel for any signs of pests, moisture or general damage
- Ensure any non FACP standby power facilities are in a state of operational readiness
- Force a suitable device, such as an MCP or detector, into an alarm state so that it generates a know alarm outcome. This process should be controlled and established in consultation with all interested parties (installing engineers include) so that maximum benefit is obtained from the test.
- Ensure the Site Log Book" is up to date, faults have been attended to and the latest test are recorded

Quarterly Operations (service contractor)

- In addition to Monthly Operational checks
- Check all internal connections and perform "alarm", "fault" and site specific tests
- Perform a "walk around" of the site to determine if the system integrity is free of possible faults
- Ensure the Site Log Book" is up to date, faults have been attended to and the latest test are recorded

Annual Operations (service contractor)

- In addition to Monthly Operational checks
- Initiate both a "lamp" and "walk" test and any other tests as determined necessary for the site
- Inspect and test (as per the manufacturers specifications) batteries
- Ensure the Site Log Book" is up to date, faults have been attended to and the latest test are recorded

Replacement Components (service contractor)

Batteries and fuses are seen as the only field replaceable components.

If a board field change is required all necessary anti-static precautions must be taken.



Note: *If the Main Board is changed the power supply may require re-calibration.*

17.2 Troubleshooting *FireFinder PLUS*

i Resolution of all suspected faults MUST only be carried out by suitably qualified technical operatives.

Problem	Solution
No Mains Power	Check mains Fuse
Power fault LED illuminated	Check output voltage it should be set to 27.6V. Low = (less than 26.5V) High = (greater than 28V) Check the battery has been connected properly
Earth Fault LED illuminated	Check all input and output cabling and wiring assemblies for short to ground
System Fault LED illuminated	Ensure correct software is installed Check all connections for loose wiring
Maintenance Alarm cleared but <i>FireFinder PLUS</i> still displays Maintenance Alarm	Carry out Loop Test
LCD displays LOOP (number) open circuit	Check in and out legs are connected correctly at the loop termination board Perform Loop test to determine the break in the wiring
Unable to clear an O/C or S/C on a loop	You must perform a loop test to clear the fault.
Communication Loop not working	Check for correct software installed in all communication boards. Check LCD at Main controller. This may identify where there is a break in the communication line
Can not access Function menu	Incorrect Password entered
Forgotten password	Ring AMPAC and directions will be given to provide you with a temporary code
An Analogue Fault occurs when using a Zone Monitor to monitor a switch.	A 1.8k Ohm resistor must be placed in series with the switch contacts.
Sounder Fault	Make sure you have a 10K Ohm EOL resistor fitted and a diode (1N4004) in series with the sounder

18 Compatible Devices

18.1 Apollo Discovery Intelligent Detectors

Heat 58000-400MAR	Optical Smoke 58000-600MAR	Ionisation Smoke 58000-500MAR	Optical/Heat Multisensor 58000-700MAR
Mounting Base 45681-210MAR	Isolator 55000-721MAR	Isolator Base 45681-211MAR	Isolating Base 45681-286MAR

18.2 Apollo Intelligent Flame Detectors

UV Flame 55000-027MAR	UV IR² Flame 55000-028MAR	IR³ Flame 55000-029MAR
---------------------------------	--	---

18.3 Apollo Intelligent Manual Call Points & Interfaces

MCP with Isolator SA5900-928MAR	Waterproof MCP Isolator 58200-976MAR	Sounder Beacon Base 45681-394MAR	Sounder Control unit 55000-181MAR
Mini Switch monitor 55000-775MAR	Zone Monitor 55000-773MAR	Switch Monitor Plus 55000-772MAR	Dual Isolator 55000-770MAR
Input/Output Unit 55000-774MAR			

19 Address Setting

BINARY ADDRESS SETTING (APOLLO)

SERIES XP95 - ADDRESS DATA

DIL SWITCH: ON = 1 OFF = 0 ADDRESS TAG FOR DETECTORS (I/O DEVICES)

DIL switch setting		DIL switch setting		DIL switch setting		DIL switch setting		DIL switch setting	
Address	1234567	Address	1234567	Address	1234567	Address	1234567	Address	1234567
1	1000000	26	0101100	51	1100110	76	0011001	101	1010011
2	0100000	27	1101100	52	0010110	77	1011001	102	0110011
3	1100000	28	0011100	53	1010110	78	0111001	103	1110011
4	0010000	29	1011100	54	0110110	79	1111001	104	0001011
5	1010000	30	0111100	55	1110110	80	0000101	105	1001011
6	0110000	31	1111100	56	0001110	81	1000101	106	0101011
7	1110000	32	0000010	57	1001110	82	0100101	107	1101011
8	0001000	33	1000010	58	0101110	83	1100101	108	0011011
9	1001000	34	0100010	59	1101110	84	0010101	109	1011011
10	0101000	35	1100010	60	0011110	85	1010101	110	0111011
11	1101000	36	0010010	61	1011110	86	0110101	111	1111011
12	0011000	37	1010010	62	0111110	87	1110101	112	0000111
13	1011000	38	0110010	63	1111110	88	0001101	113	1000111
14	0111000	39	1110010	64	0000001	89	1001101	114	0100111
15	1111000	40	0001010	65	1000001	90	0101101	115	1100111
16	0000100	41	1001010	66	0100001	91	1101101	116	0010111
17	1000100	42	0101010	67	1100001	92	0011101	117	1010111
18	0100100	43	1101010	68	0010001	93	1011101	118	0110111
19	1100100	44	0011010	69	1010001	94	0111101	119	1110111
20	0010100	45	1011010	70	0110001	95	1111101	120	0001111
21	1010100	46	0111010	71	1110001	96	0000011	121	1001111
22	0110100	47	1111010	72	0001001	97	1000011	122	0101111
23	1110100	48	0000110	73	1001001	98	0100011	123	1101111
24	0001100	49	1000110	74	0101001	99	1100011	124	0011111
25	1001100	50	0100110	75	1101001	100	0010011	125	1011111
								126	0111111

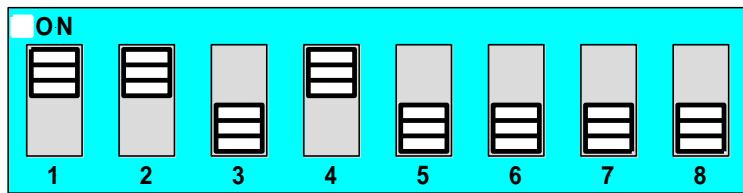
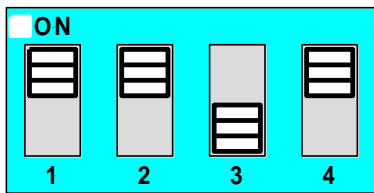
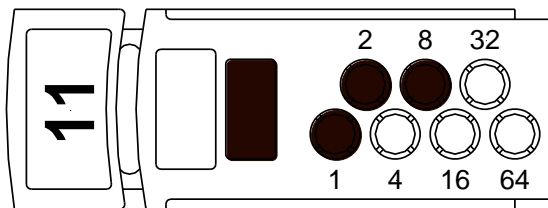

Figure 87: 4 and 8 way Switch addressing set to Address 11



● = PUNCH OUT

Figure 88: Xpert Card addressing set to Address 11

20

Specifications

	Metal SP1M (LPCB Approved)
Mechanical	
Dimensions Cabinet: (mm)	505 (H) x 407 (W) x 150 (D)
Material	1.2mm Mild Steel
Environmental	
Temperature:	-5°C to + 55°C
Humidity:	25% to 95% non condensing
IP rating	IP30
Mains Input	
Input Voltage:	195 - 264VAC
Protection (Quick Acting Fuse):	
5 AMP Supply	2Amp 3AG Slow Blow
14 AMP Supply	N/A
Minimum Cable Requirements:	Not less than 0.75mm ²
Power Supply	
Operating Voltage Range:	20 - 28.2VDC
Power Supply Ripple Voltage:	<250mV
Power Supply Output Current:	5.6Amps
Imax A	3Amps
Imax B	5.5Amps
Protection	Current Limiting
Batteries / Battery Charger	
Charger Float Voltage (Temp compensated):	26.6-28.2VDC (27.3VDC nom @ 20°C)
Approved LPCB Battery:	Genesis NP24-12R
Battery Type:	2x12V Sealed Lead Acid
Max Battery Capacity:	24AH
Max Charger Current Limited:	1.25A
Battery Supply Current Limited:	3A and 2A PTC
Battery Low:	<23VDC
Battery Discharged Cut-off Voltage:	<21VDC
Max Battery Resistance	0.75Ω
Panel	
Quiescent Current (QI) 1 Loop	220mA
Max Number of Zone LEDs:	64
Loop	
Maximum number of Loops:	4
Maximum Number of Zones:	64
Maximum Number of Devices:	126 / loop
Loop Current	500mA / loop
Cabling Requirements:	2 core 1.5 -2.5mm ² Max length 1km
Fault supervision:	O/C, S/C , over current
Outputs	
Supervised Alarm (Current Limited)	24VDC @ 1A Max O/C, S/C, 10K EOL
Alarm / Fault Relay Contacts	24VDC @ 1A
Auxiliary VDC – Protected	24VDC @ 2A
Cabling Requirements:	2 core 1 -2.5mm ² Max length 1km
Inputs	
Supervised	O/C, S/C, 10K EOL
Cabling Requirements:	2 core 1 -2.5mm ² Max length 1km
Communications	
Add-on Module Internal to FACP	RS485
External to FACP	RS485

21 QUICK REFERENCE GUIDE

NOTE:
 1: At Access Level 1, the entire MENU is not accessible.
 2: At Access Level 2, the MENU is active and partial FUNCTION options are active.
 The user shall be presented with the ACCESS option to enter the level 3 FUNCTION's
 3: At access level 3, all FUNCTION options are available

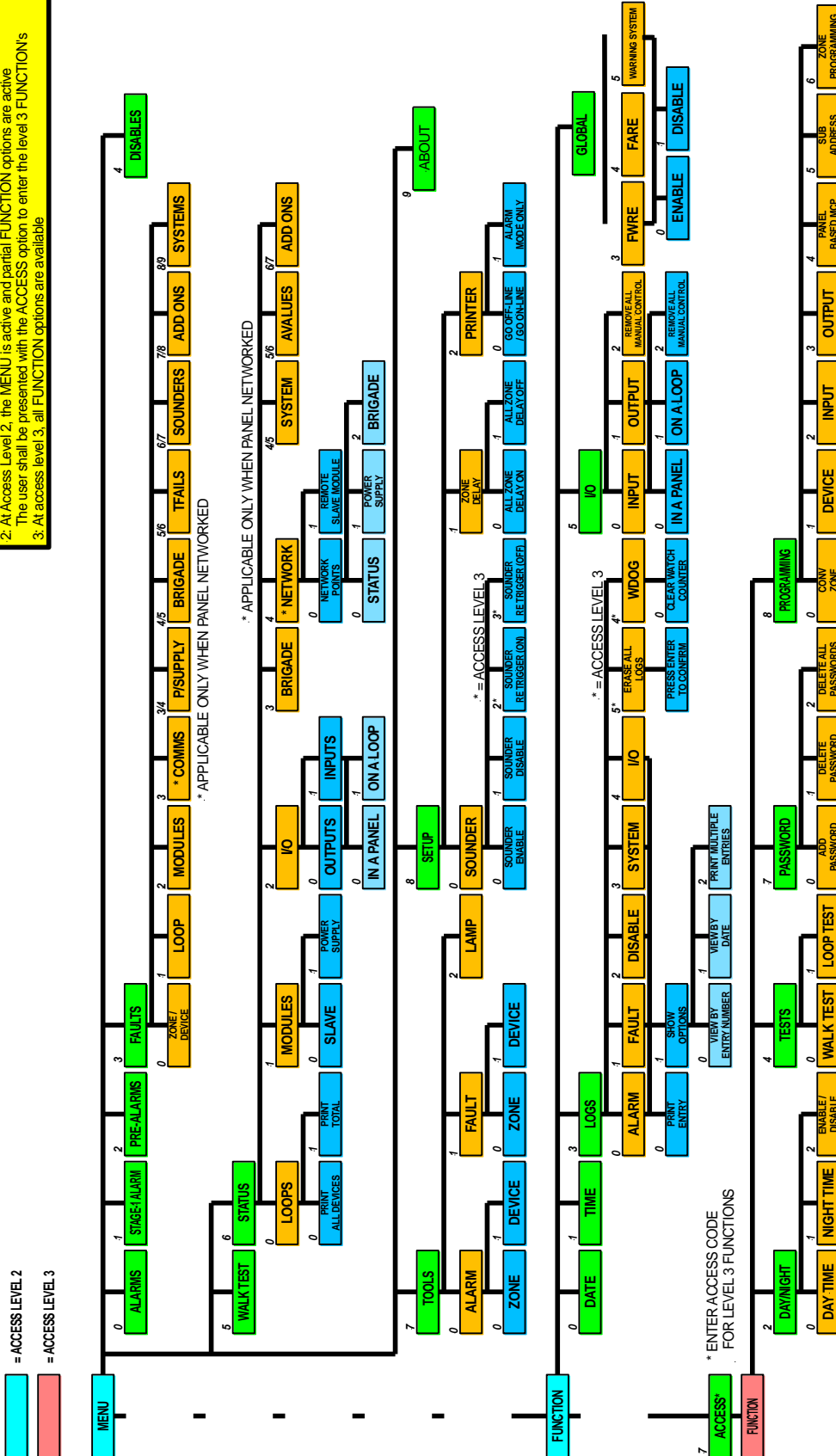

Menu Flow v1.2



AMPAC Technologies Ltd
7 Ledger Road Balcatta, Western Australia, 6021

EN54-2 & 4 1997 including amendments 1 & 2

Control and Indicating equipment and Power Supply equipment for fire detection and fire alarm systems for buildings

8681-0108 FireFinder Plus 1 Loop 32 Zone analogue addressable control and indicating equipment

8681-0208 FireFinder Plus 2 Loop 32 Zone analogue addressable control and indicating equipment

8681-0308 FireFinder Plus 3 Loop 32 Zone analogue addressable control and indicating equipment

8681-0408 FireFinder Plus 4 Loop 32 Zone analogue addressable control and indicating equipment

Provided options:

Output to fire alarm devices

Output to fire alarm routing equipment

Delay to outputs

Dependencies on more than one alarm signal – Type A

Dependencies on more than one alarm signal – Type B

Dependencies on more than one alarm signal – Type C

Fault signal from point

Output to fault warning routing equipment

Disablement of each addressable point

Test condition



www.ampac.net