



Fire detection and evacuation solutions that save lives.



Ampac Test Set

User Manual

MAN3121-1

Contents

1	Safety first.....	4
2	Technical information	4
3	Where do I find things?.....	5
4	How do I switch the Test Set on?.....	5
5	What do I see when the Test Set is switched on?	6
6	How do I switch the test set off?	7
7	How do I control the touchscreen?.....	7
8	What are Device range and Device type test set IDs?	8
9	How do I navigate through the various menu screens?.....	10
10	How do I use the Settings?	11
10.1	Screen settings	11
10.2	Locations	12
10.3	Cable types.....	13
10.4	Setting the date and time	15
10.5	Setting the language.....	15
10.6	About	15
11	How do I use the Loop View menu?.....	16
11.1	Selecting a polling range.....	18
11.2	Viewing the details of a single address.....	18
11.3	Changing the output bit status	20
11.4	Self-test.....	21
11.5	Fast Test.....	21
11.6	Isolator control	22
11.7	Configuration status	23
11.8	Mode and polling LED.....	23
11.9	Analogue Value/Drift.....	25
11.10	Control and Status	26
11.11	Events.....	27
11.12	Event logs	29
11.13	Data log	30
12	How do I use Programmer mode?	31
12.1	Self-test.....	32
12.2	Fast Test.....	32
12.3	LED Test	33
12.4	Sensor status	34
12.5	Settings	34
12.6	Mode	34
12.7	Polling LED.....	35
12.8	Rapid update	35
12.9	Soft address (function not available at present).....	35
	35
12.10	Restore to factory defaults	36
12.11	Sounders	36
12.12	Operate relays	37
13	How do I use Loop diagnostics?.....	38
13.1	Short circuit fault.....	39
13.2	Earth fault	39

13.3	Cable impedance and cable run	40
13.4	Loop supply - from direction OUT	40
13.5	Loop supply - from direction IN	41
13.6	Occupied address search	42
13.7	Loop devices map building.....	43
13.8	Earth fault location search	43
14	How do I enter a location?	45
15	How do I use Stored Events , Data logs?	46
16	How do I update firmware?	48
17	Troubleshooting	50
18	How do I do a hard reset?	51
19	How do I replace the battery pack?	51
20	Appendix A - Menu tree	52
21	Appendix B - Short circuit and earth fault detection flowchart.....	53
22	Appendix C - Loop supply from direction OUT	54
23	Appendix D - Loop supply from direction IN	55
24	Appendix E - Earth fault location search	56
25	Appendix F – Firmware update.....	57
26	Appendix G – Line Voltages	58

1 Safety first



Read this User Manual completely before using the Ampac Test Set.

The Ampac Test Set is electronic test equipment and care should be taken when handling and storing. Dropping the unit onto a hard surface could damage it.

The Ampac Test Set is designed for indoor use only and should not be subjected to harsh environments. It is not designed for use in hazardous areas - those containing explosives or dust. Do not use the Test Set in places where temperatures and/or humidity are high or go through rapid changes.

Do not use the Ampac Test Set if it is not operating correctly - consult the troubleshooting section or seek technical advice.

If the Ampac Test Set is used in a manner not specified by the Manufacturer, the protection provided by the equipment may be impaired and the warranty invalidated.

2 Technical information

Power source	Lithium-ion battery pack or 12 V Power Supply Unit
Battery charging time	Approx 3 hours
Operating temperature	0 °C to 40 °C
Humidity – no condensation or icing	10 to 95 % RH
Dimensions	215 mm x 165 mm x 50 mm
Weight	935 g

3 Where do I find things?



4 How do I switch the Test Set on?

To switch the Test Set on, press and hold the green power on button on the side of the unit. When the power LED lights up you can release the power on button.

5 What do I see when the Test Set is switched on?

When the Test Set is first switched on the title screen appears with a segmented circle revolving in the centre indicating that the software is being loaded. When the load is complete the Home Screen appears.



From the Home Screen you are able to access the six main menus:

- Settings

This menu enables you to change some of the settings of the Test Set such as the Screen settings, Location and cable type. These are explained on page 7.

- Loop View

The Loop View menu enables you to access a further six sub-menus. These are explained on page 12.

- Programmer Mode

The programmer Mode menu enables you to do various tasks on the system. These are explained on page 25.

- Loop Diagnostics

The Loop Diagnostics menu enables you to troubleshoot the system. This is explained on page 31.

- Location

This enables you to enter the location. This is explained on page 37.

- Stored Events, Data logs

This menu enables you to view stored event and data logs. This is explained on page 38.

6 How do I switch the test set off?

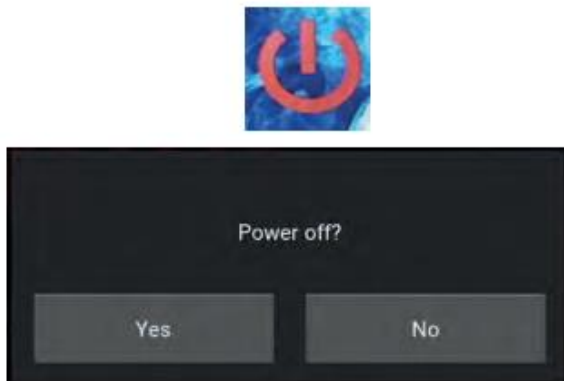

On the Home Screen, tap the 'Power Off' icon.

The 'Power-off' splash screen appears.

Tap 'Yes' to power off the unit.

7 How do I control the touchscreen?

The touchscreen is controlled using a finger and swiping in different directions to select things on the screen. In this User Manual the icons that follow are used to show how to move around the touchscreen.

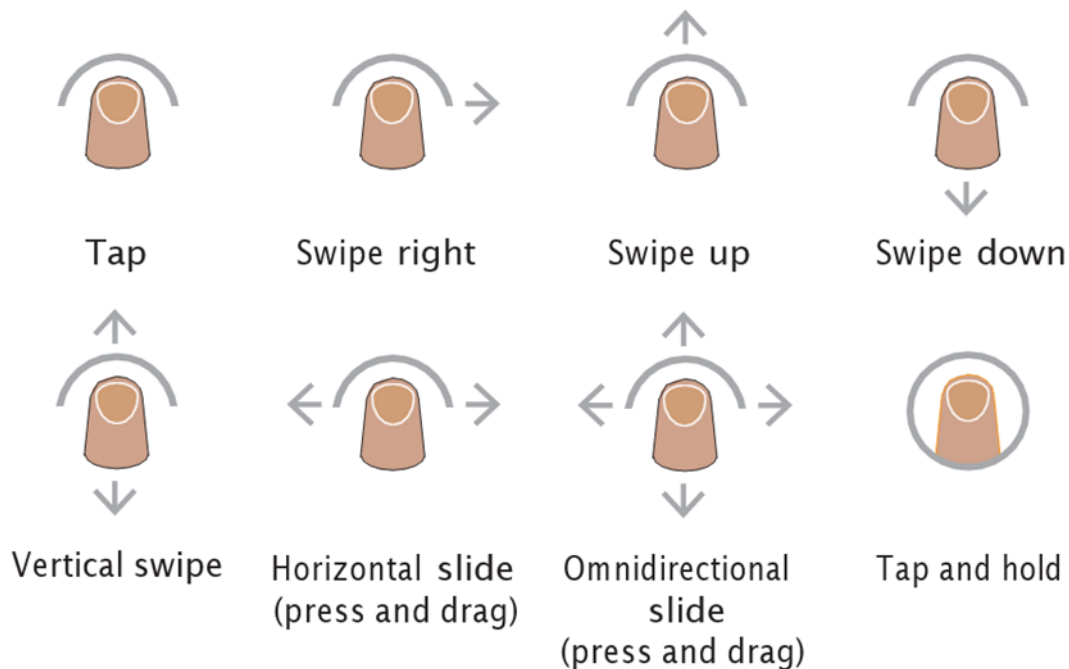

8 What are Device range and Device type test set IDs?

Before using the Test Set it is important that you understand the abbreviations that are used on the various screens for different device ranges and types that are used on the test set. The table that follows defines these abbreviations. It may be long but it is necessary for you to be able to understand the information being given on the screen. Each screen is divided in sections, one section for each device. Each section contains:

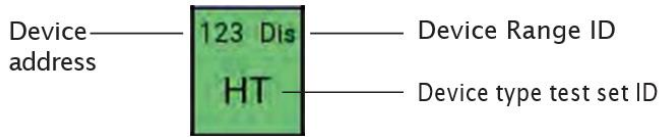

Device range ID	Range	Description
Dis	Discovery	covers all Discovery devices including Discovery UL
Sot	Soteria	all Soteria devices
XP	XP95	covers XP95, XPlover, XP95 I.S. and XPander devices
XPa	XP95A	used for XP95A devices with unique type codes
S90	Series 90	covers all Series 90 devices
U	User	covers all User type codes

Device type test set ID	Description
SUM	Shop Unit Monitor/User Defined
UD1	User Defined
UD2	User Defined
UD3	User Defined
SND	Sounder Controller, Sounders, Visual Indicators, VADs (Base and Open Area), Sounder Control Module
	Sounders, Visual Indicators and VADs (Base and Open Area)
	Sounder Control Module
	Sounder Beacon Base and Open Area
	Sounder Base
	Voice Sounder Beacon
	Voice Sounder
	Reserved
I/O	Single Channel I/O Unit, Switch Monitor Unit, Three Channel I/O Unit and Three Channel I/O Unit (Analogue)
	I/O Output Units and XP95A Relay Output Module
	Input Unit (1 I/P, Faceplate and DIN-rail)
	Output Unit (1 O/P, Faceplate and DIN-rail)
	I/O Unit (1 I/P, 1 O/P, Faceplate and DIN-rail)
	Mains I/O Unit (2 I/P, 1 O/P, Faceplate and DIN-rail)
	I/O Unit (2 I/P, 2 O/P, Faceplate and DIN-rail)
	Input Unit (4 I/P, Faceplate and DIN-rail)
I/O Unit (4 I/P, 4 O/P, Faceplate and DIN-rail)	
MMM	Mini Switch Monitor Module and Mini Monitor Module
SMM	Switch Monitor Module
	Switch Monitor I/O Module and 120 V I/O Module
ION	Ionisation detector
CO	CO Gaseous Fire Detector
COH	CO/Heat Multisensor (without isolator)
	CO/Heat Multisensor (with isolator)
	UL CO Base
ZMU	Control Unit Monitor and Zone Monitor Unit
	Zone Monitor Unit and XPander Interface
SM	Mini Switch Monitor, Switch Monitor and Switch Monitor Plus
	Switch Monitor Plus
	Switch Monitor
ASD	Aspirating Detectors
OP	Optical detector (without isolator) and End-to-End Beam detector (EUR)
	Optical detector (without isolator)
	Optical detector (with isolator)
BD	Beam Detector (USA) and Reflective Beam detector
	Reflective Beam detector
FD	Flame detector - all types
OPH	Multisensor (Opt/Heat, without isolator)
	Multisensor (Opt/Heat, with isolator)
	Multisensor (Opt/Heat, with isolator) (Quad)

HT	Heat detector (without isolator)
	Heat detector (with isolator)
	High temperature heat detector
MCP	Manual Call Point and Manual Call Point Monitor
	Manual Call Point and Mini Switch Monitor with interrupt
	Soteria Manual Call Point without isolator
	Soteria Manual Call Point with isolator
MPS	Mini Priority Switch Monitor Module, Mini Monitor Module and Pull Station
PSM	Priority Switch Monitor Module

Now we've got those bits explained there is just one more thing that is common to all menus that you need to know about.

9 How do I navigate through the various menu screens?

By swiping right on the left of the screen the menu selection bar appears.

Tap the menu you want to move to and the main screen changes. Tap Home to return to the Home Screen. The menu selection bar moves out of view after you have made your selection.



10 How do I use the Settings?



To access the Settings, tap the Settings icon on the top bar. Settings are divided into five groups:

- Screen
- Locations
- Cable types
- Date and Time
- Language

10.1 Screen settings



To adjust the screen brightness, press and hold the slider. Move it to the right to make the screen brighter, move it to the left to make the screen less bright.

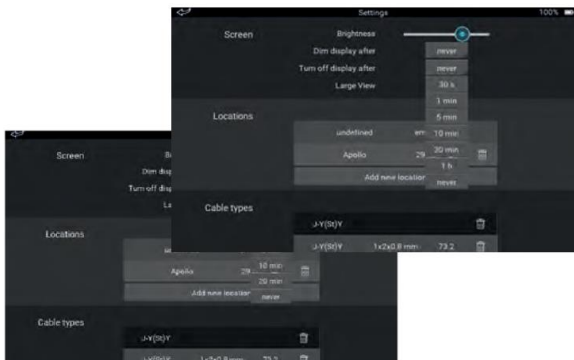

It is also possible to adjust the length of time after which the screen brightness is automatically reduced and when the display is turned off.

Tap the box next to either 'Dim display after' or 'Turn off display after'. A drop down menu appears. Tap the time that you require. The drop down menu closes.

Tap 'Large View' to increase the screen font size.

10.2 Locations

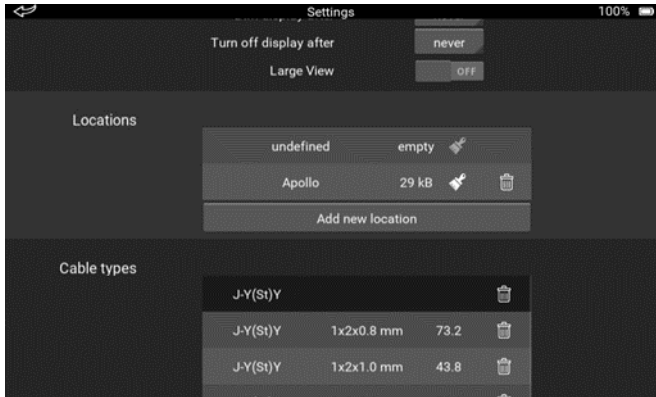

The Locations section of the Settings screen enables you to:

- Add a new location
- Remove a location from the list
- Clear all data at the selected location

Alongside the location name you will find how much memory the data is taking up and two other icons; one that looks like a brush and one that looks like a dustbin.

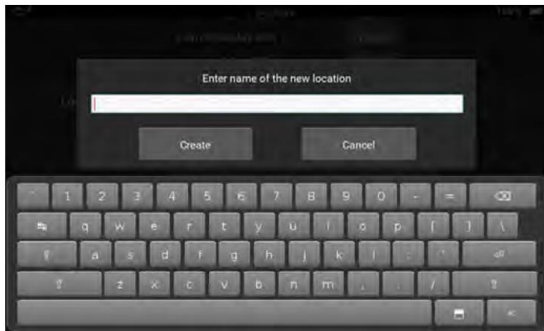

To add a new location, tap 'Add new location'. The on-screen keyboard appears. Use the keyboard to enter the name of the new location.



Tap 'OK' to return to the Settings screen.



To clear stored data from a location, tap the brush icon. A splash screen appears asking you to confirm that you want to clear the data. Tap 'Yes' to clear the data.

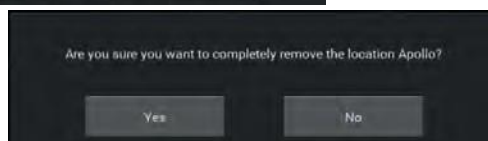

To delete the location, tap the dustbin icon. A splash screen appears asking you to confirm that you want to delete the location. Tap 'Yes' to delete the location.

10.3 Cable types



The Cable types section of the Settings screen enables you to:

- Add a new cable type to the list
- Add new dimensions to a cable type
- Remove a cable type from the list
- Remove a dimension from the list

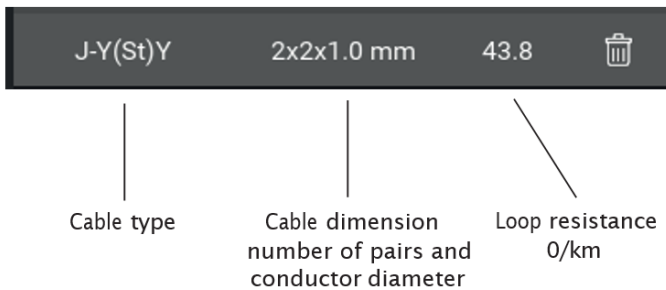

Each cable type gives additional information:

- Cable type
- Cable dimension
- Loop resistance



To add a new cable:

Tap 'Add new cable type'. The on-screen keyboard appears.

Enter the name for the new cable.

Tap 'Create', the new cable is added to the list.



To add dimensions:

Tap to select the cable type.

Tap 'Add new dimension'. The on-screen keyboard appears.

Enter the new dimension and loop resistance. Tap 'Create' the new dimension is added.



To remove a cable type from the list, tap the delete icon alongside the cable type.

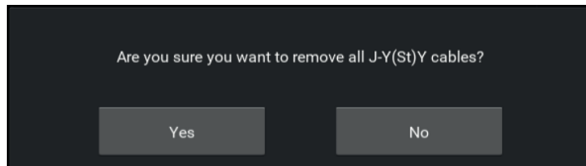

A splash screen appears asking you to confirm cable removal.

Tap 'Yes', the cable type is removed.



To remove a cable dimension from the list, tap the delete icon alongside the dimension.

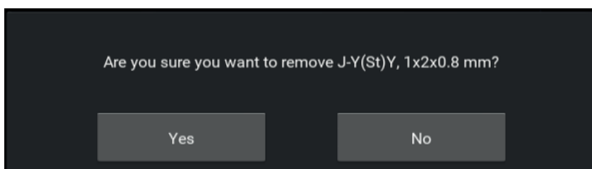

A splash screen appears asking you to confirm the dimension removal.

Tap 'YES', the dimension is removed.



10.4 Setting the date and time

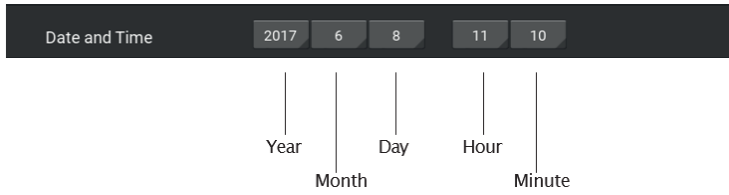

The date and time are set out as shown on the left.



To set the date and time:

Tap each section, a drop-down menu appears. Select the required option for each section.

10.5 Setting the language

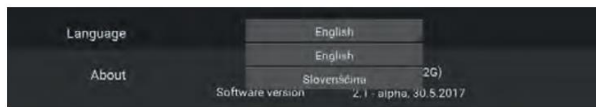

To set the language, tap the language box, a drop-down menu appears. Select the required language from the options.

10.6 About

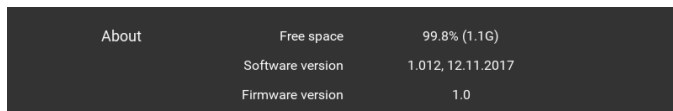

The About section of the Settings screen shows:

- Free disc space (percentage and actual)
- Version of software installed
- Version of firmware installed

11 How do I use the Loop View menu?

When using the Loop View menu the device status is indicated using the colours that follow:

Corrupt data	Empty address	Dual address	Analogue value ≥ 8	$8 <$ analogue value ≤ 44	$45 \leq$ analogue value ≤ 54	Analogue value ≥ 55	Drift Value $> 30^*$

* small rectangle with a yellow number - used only in Analogue Value/Drift sub-menu



On the Home Screen tap the Loop View tab. The address scan screen appears.

It shows all of the allocated addresses on the loop and their status.

By default the Test Set uses the XP95/Discovery protocol. If it is a CoreProtocol loop that you are working on you need to change the protocol as follows.



At the top of the address scan screen swipe down. The top bar appears.

It contains several icons, but the one we need is the protocol change icon.

The active protocol is highlighted in orange.

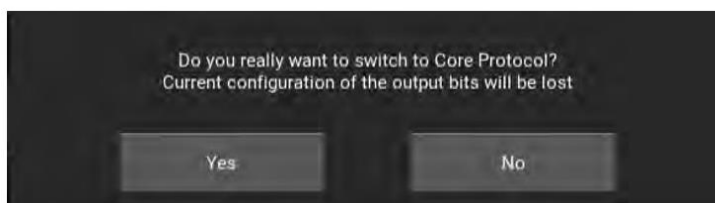

Tap the protocol change icon. A warning screen appears.

Tap 'Yes' - XP95/Discovery will change to grey and CoreProtocol will change to orange.

The protocol change is now complete.

Whilst we are talking about the top bar lets see what the other icons mean:



Direction enabled (yellow)/disabled (grey) - tap to change the current status



Voltage 28 V/35V - tap the icon to switch voltages (CoreProtocol only) - see below



Sounder synchronisation - tap to synchronise sounders

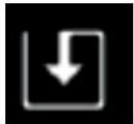

Tap to save Loop Report/Loop configuration (only available in Control and Status - Mode and Polling LED)



Loop health - calculation based on received data (address confirmation, a parity bit and checksum)



Loop noise - this is a calculation based on current pulse amplitude

Noise level (%)	Meaning
0	Theoretical minimum
4	Clean installation
36	Good installation in an industrial environment
80	Bad installation (segregation, multiple address loops on the same cable, bad junction points) or long installation in a very severe industrial environment
100	Very bad installation (earth fault, bad junction points, crosstalk)

Acceptable value is a value below 80%



Absolute polling range - the total number of devices with the same status. Colours are defined on page 8.

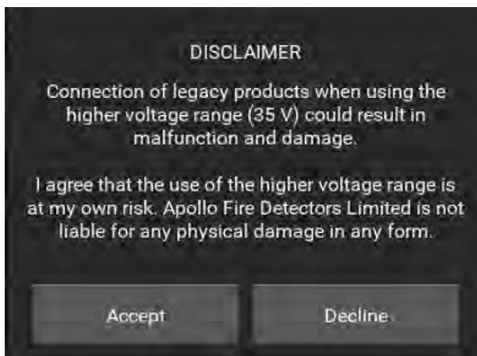

To change voltage range, tap the Voltage icon. The message 'Loop Scanning' appears.

If changing voltage is possible, the Disclaimer splash screen appears. Tap 'Accept' to change voltage.

If a voltage change is not possible, the message 'Switching to 35 V is not possible' appears.



To close the top bar, swipe up.

With the basics of the Loop View menu covered, let's do a few tasks:

11.1 Selecting a polling range



To select a range of addresses to be polled, press and hold at the starting address, then slide your finger to the finishing address. The selected polling range is highlighted on the screen.

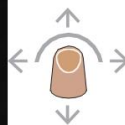

11.2 Viewing the details of a single address

To see the details of a particular address:



On the address scan screen, tap the device that you want to see the detail of. The single address splash screen appears





The single address splash screen gives information on:

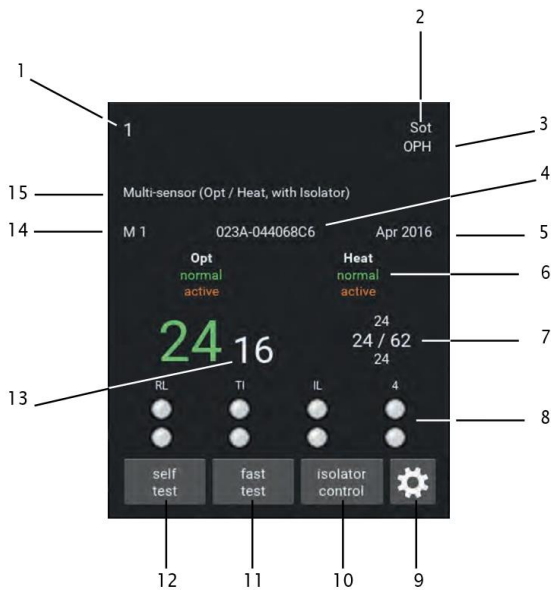

Key

- 1 Device address
- 2 Range ID - see page
- 3 Device type test set ID - see page
- 4 Serial Number in HEX XXXX-XXXXXXXX (MSB to LSB)
- 4* (MSB to LSB)
- 5 Manufacture date - first three letters of month, year
- 6 Sensor status - first row, sensor type, second row live sensor status, third row last sensor status.
- 6* Blue - fault, Green - normal, Orange - active, Red alarm
- 7 Analogue value - max/min/average
- 8 Input/Output status. Top row - bit name - see page 10, Middle row - output bit status, Bottom row - input bits status. Red -On, Grey - Off
- 9** Configuration status
- 10** Isolator control
- 11 Fast Test - tab only enabled for devices that allow fast test
- 12 Self Test - tab only enable for devices that allow self test
- 13 Drift Value
- 14*** Detection Mode
- 15 Description of device type

* Soteria devices only ** Soteria devices that allow this option only *** Discovery and Soteria devices only

Abbreviation	Output bit name
BO	Beacon On
CO	Continuous Output
DL	Detector LED
EV	Evacuate
FS	Fault Simulation
GA	Group Addressing
IL	Internal LED
NU	Not Used
OR	Output Relay
PO	Pulsed Output
RL	Remote LED
RO	Remote ON
RS	Reset
SO	Sounder ON
TI	Test Initiated

11.3 Changing the output bit status



To change the output bit status of a particular device, tap on the required address, the single address splash screen appears.



Tap the output bit icon that you want to change the status of.



To close the single address splash screen, tap on the main screen to the left of it.



However, for details of self test, fast test, isolator control and configuration settings - read on.

11.4 Self-test

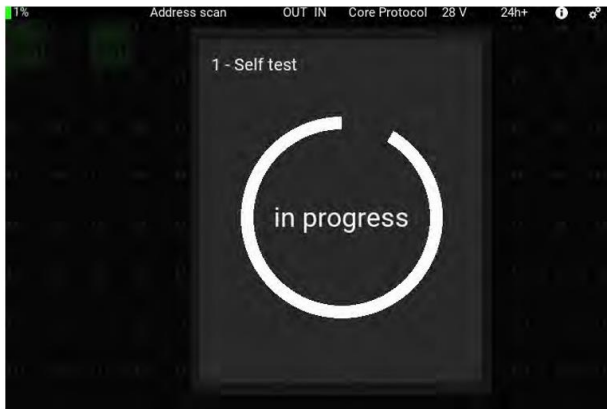

Tap the Self Test button, the self test is activated immediately. The circle represents a countdown timer which is set at 20 seconds. If the analogue value increases to 55 before the timer expires, a 'Pass' splash screen appears, otherwise a 'Fail' splash screen appears.



If you

want to stop the self test, or close the splash screen after the test, just tap on the main screen, to the left of it.

11.5 Fast Test

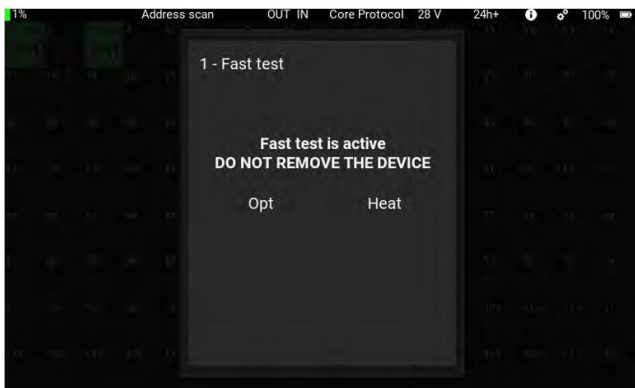

Tap the Fast Test button, the fast test is activated immediately. If a fast test cannot be done - a message 'Fast test cannot be performed' appears and the splash screen returns to the single address view.

If the message shown on the left appears, the fast test is active and you should apply smoke or heat to the detector as appropriate.

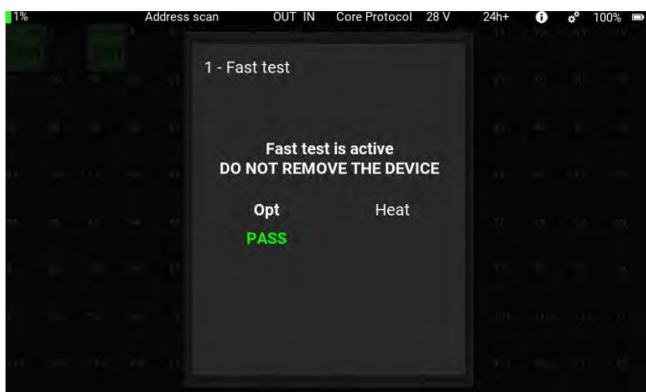

When the sensor in the detector has entered alarm, the green 'Pass' text will appear and the sensor name changes to green. The sensor name remains green until the analogue value returns to its initial value, the sensor name then changes to white.

To stop the test or close the Fast Test splash screen, tap on the main screen to the left of it. The data restore operation starts.



(a)

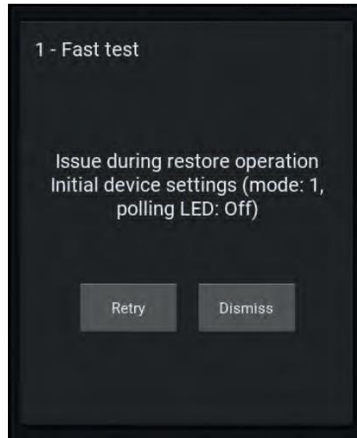

(b)

If the device successfully passes the data restore operation, the 'Data restored' splash screen (a) appears. If the data restore is not successful the 'Issue during restore operation' splash screen appears along with details of the initial device settings (mode, polling LED status). Tap either 'Retry' or 'Dismiss' as appropriate. 'Retry' will start the test again. 'Dismiss' closes the Fast Test splash screen.

11.6 Isolator control



The Isolator Control button is used to switch the device isolator on or off.

To switch the isolator on, tap the isolator button. As the isolator switches on the colour of the button changes to blue.

Tap the button again and the isolator switches off and the colour of the button changes to grey.

11.7 Configuration status



Tap the Configuration Status button to show the configuration status of any Soteria device on the loop.



The Configuration Status splash screen appears.

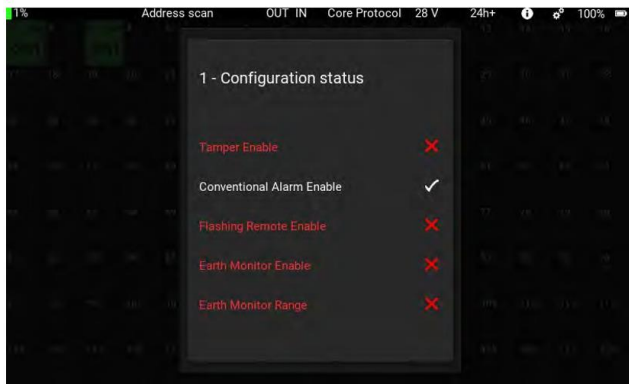

Tap to change the status of any of the listed items.

White text and a tick shows the item is enabled.



Red text and a cross shows the item is disabled.

Tap anywhere outside of the splash screen to close it and return to the single address splash screen.

11.8 Mode and polling LED

This menu enables you to see the mode and LED status of the devices on the loop.

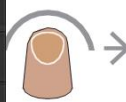

Swipe right from the left side of the screen. The menu selection bar appears.



Tap 'Mode and Polling LED'. The menu selection bar closes and the Mode and Polling screen appears.



The mode and LED status for each device is shown.

Each device shows the information that follows:

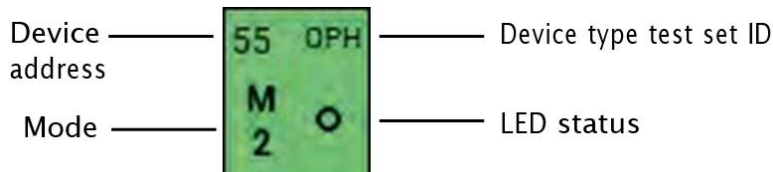

Note: In the case of Series 90 and XP devices the mode and LED status will be blank.

The mode and status information shows:

- M
2 Device mode (in this instance Mode 2)
- LED status (if this section is empty the status is not available)
 - LED off
 - ☀ LED on

11.9 Analogue Value/Drift

This menu enables you to view the analogue and drift values of the devices on the loop.



Swipe right from the left side of the screen. The menu selection bar appears.



Tap 'Analogue value/Drift'. The menu selection bar closes and the Analogue value and Drift screen appears.



The Analogue value and Drift values for each of the devices is shown.

Each device shows the information that follows:

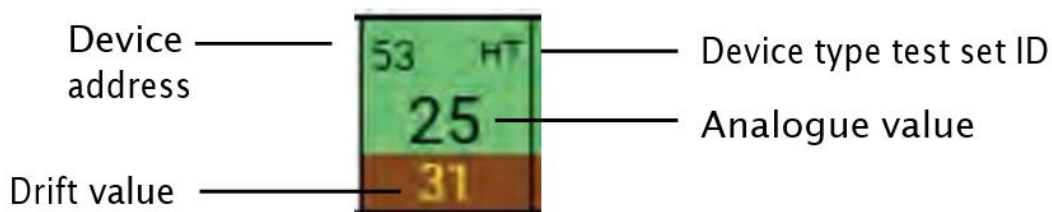

Note: In the case of Series 90, XP devices and certain Discovery and Soteria devices (MCP, I/O and SM) drift value is not shown.

11.10 Control and Status

This menu enables you to view the current status of input and output bits.

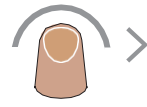

 Swipe right from the left side of the screen. The menu selection bar appears.

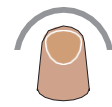
 Tap 'Control and Status'. The menu selection bar closes and the Control and Status screen appears.

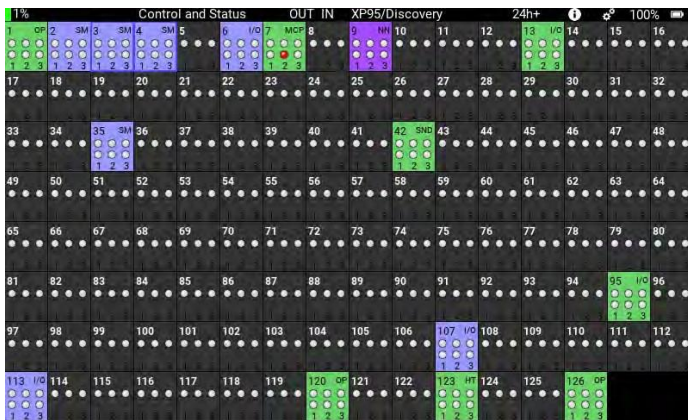

The current status of input and output bits for each device is shown.

Each device shows the information that follows:

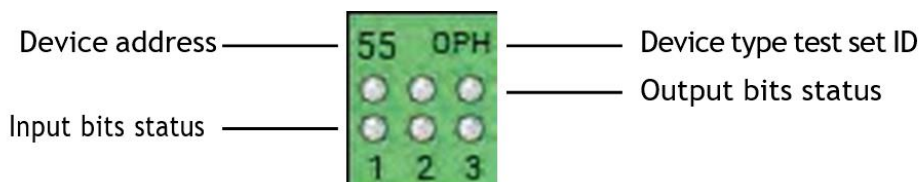

Note: In the case of an empty address only the status of output bits is shown.

The input/output bits status icons are:



If there is no status icon the information is not available

11.11 Events

The Events menu shows event flags, event types and event addresses. When the Events menu is selected the unit starts recording (indicated by a flashing red LED in the title bar) all events that occur. The type of event and the device status is shown by different colours:

Occupied address	Empty address	Dual address	Tamper*	Alarm*	Fault*
------------------	---------------	--------------	---------	--------	--------

*Note: * indicates the event on the device at the given address*



Swipe right from the left side of the screen. The menu selection bar appears.

Tap 'Events. The menu selection bar closes and the Events screen appears.



The event status of each device is shown.

Each device shows the information that follows:

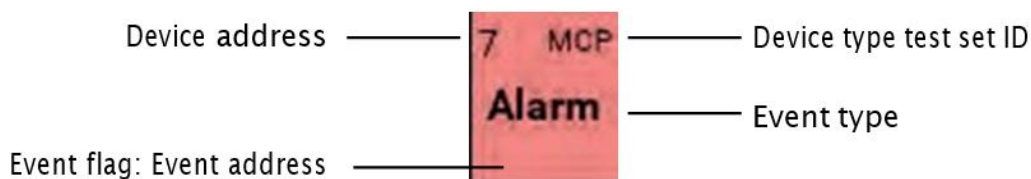

Examples of the event types, event flag: event address are:

	Description	Text on screen
Event	Alarm, MCP alarm	Alarm
	Fault	Fault
	Tamper	Tamper
Event flag: event address	The device at the address 10 placed an alarm bit	A:10
	The device at the address 1 placed an interrupt bit	I:1

11.12 Event logs

To show event logs:

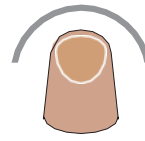

To see the events for an individual device. Tap on the required address. The event log appears in front of the event screen.

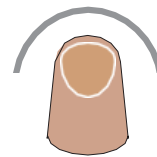
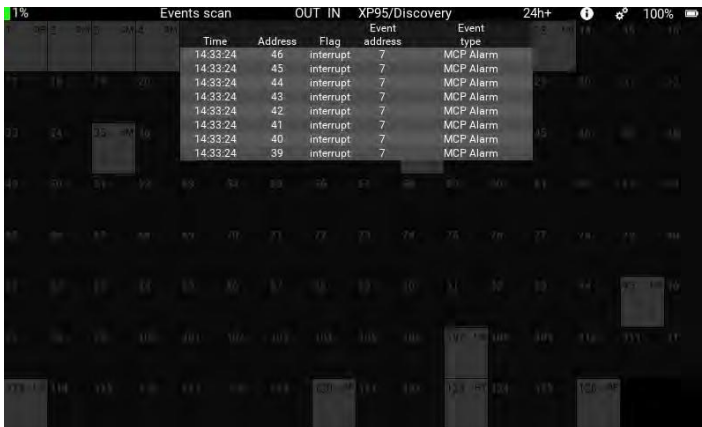

The event log shows a list of events for the individual device.

To close the event log, tap the screen.

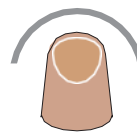
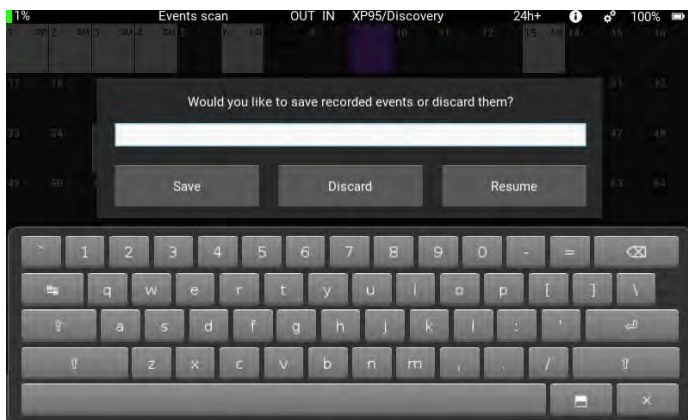

When you try to select a new sub-menu, the save event log screen appears.

If you want to save the event log, enter a name for the file using the on-screen keyboard and then tap 'Save'.

If you want to delete the log, tap 'Discard'.

If you want to continue with the log, tap 'Resume' and the recording of events for that device continues.

After you have made you selection the save event log screen closes.

11.13 Data log

This menu gives a list of all events on the loop. This can range from mismatched data through to the current device status. When you select the data log menu the unit starts recording data logs for each individual address. Changes on each address are shown by different colours.

Occupied address	Empty address	Dual address	Mismatched data
			Event flag at this address



 Swipe right from the left side of the screen. The menu selection bar appears.

 Tap 'Data Log'. The menu selection bar closes and the Data Log screen appears.



 Tap on the address that you want to see the data log. The data log splash screen appears,

Parameter	Description
Address	polled device
Device type	encoded (device type test set ID) and match (☑)/mismatched (X) if current device type does not match initial one, counter value will increase)
Address confirmation	match (☑)/mismatched (X) - if current address confirmation does not match initial one, counter value will increase
O/P bits	current status - abbreviations for output bit names - if they are set
I/P bits	match (☑)/mismatched (X) - if current I/P bit status does not match initial one, counter value will increase
Analogue value	min/max/last
Drift flag	match (☑)/mismatched (X)
Events flag	event flags and event address (e.g. I,1 - device at the address 1 placed interrupt bit) - if any event flag is set, counter value will increase
Parity	correct (☑)/incorrect (X)
Power-up flag	match (☑)/mismatched (X) - Soteria devices only, blank for all other devices
Checksum	correct (☑)/incorrect (X) - Soteria devices only, blank for all other devices

12 How do I use Programmer mode?

Programmer mode is used with the detector base provided. In this mode only CoreProtocol is used. The detector mounting base with an XPERT8 address card with a pre-defined address of 1.

The detector mounting base will accept all detector types - Series 90, XP95, Discovery and Soteria. The detector base is connected to the test set unit using the supplied cables into the appropriate connections on the top of the unit.

The Test Set can also be used with manual call points, switch monitors, input/output devices and sounders.

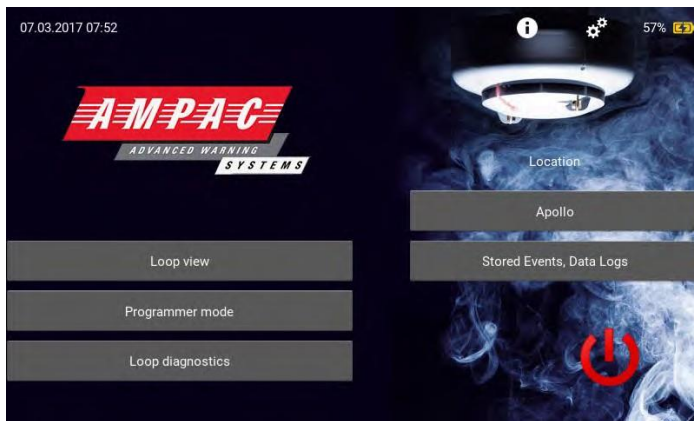

Insert the required device into the detector base.

Tap the 'Programmer mode' tab on the Home screen.

The programmer mode splash screen appears.

Note: If no device is detected 'Device not fitted' appears on the splash screen.

The Programmer mode splash screen shows this information:

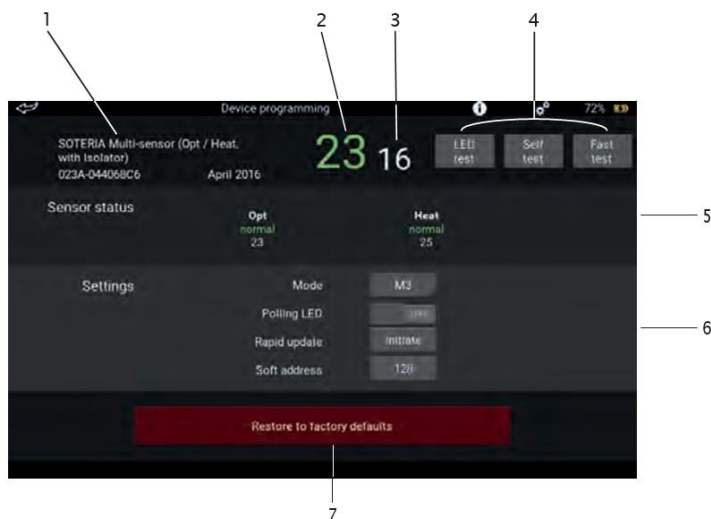

- 1 Currently fitted device information
 1. Device type description
 2. Serial number in hex XXXX-XXXXXXXX (MSB to LSB)*
 3. Date of manufacture - month name, year)**
- 2 Live analogue value
- 3 Drift value - if device is enabled for this
- 4 Test buttons - only enabled if device will allow these tests.
 - Grey button - deactivated
 - Blue button - activated
- 5 Sensor status*
- 6 Settings ** - available options depend on device type code
- 7 Restore to factory defaults button**

*Note: * Soteria devices only, ** Soteria and Discovery devices only*

12.1 Self-test

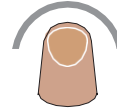
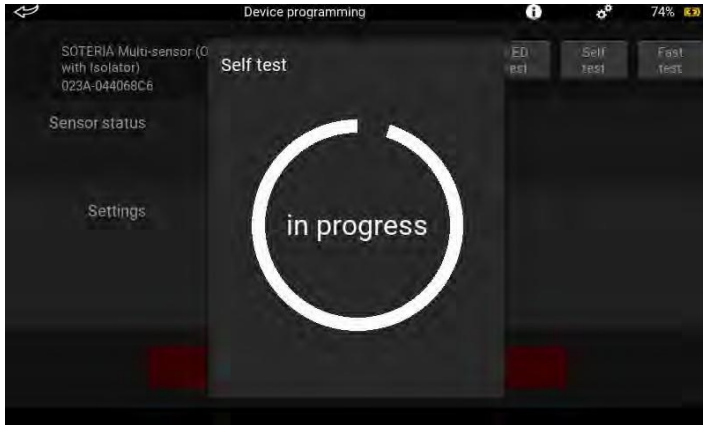

Tap the Self Test button, the self test is activated immediately. The circle represents a countdown timer which is set at 20 seconds. If the analogue value increases to 55 before the timer expires, a 'Pass' splash screen appears, otherwise a 'Fail' splash screen appears.

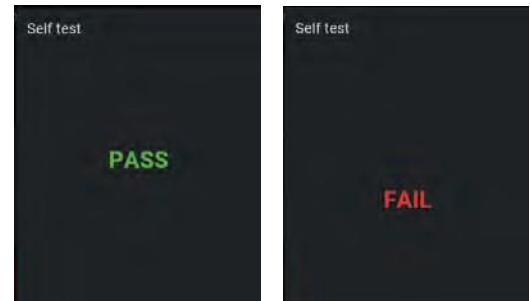

If you want to stop the self test, or close the splash screen after the test, just tap on the main screen, to the left of it.

12.2 Fast Test



Tap the Fast Test button, the fast test is activated immediately. If a fast test cannot be done - a message 'Fast test cannot be performed' appears and the splash screen returns to the single address view.

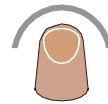

If the message shown on the left appears, the fast test is active and you should apply smoke or heat to the detector as appropriate.

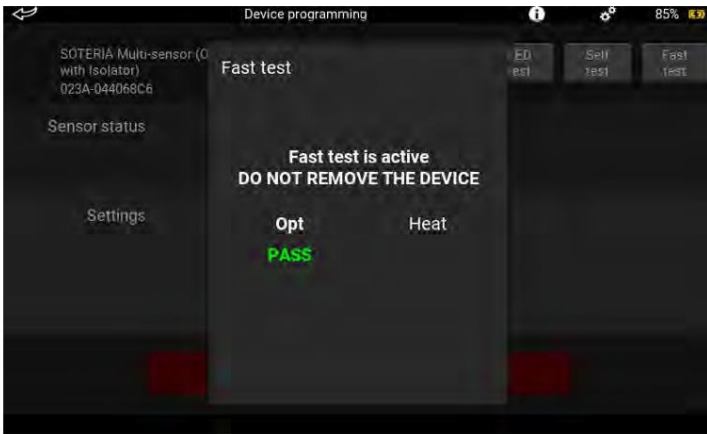

When the sensor in the detector has entered alarm, the green 'Pass' text will appear and the sensor name changes to green. The sensor name remains green until the analogue value returns to its initial value the sensor name then changes to white.

To stop the test or close the Fast Test splash screen, tap on the main screen to the left of it. The data restore operation starts.



(a)

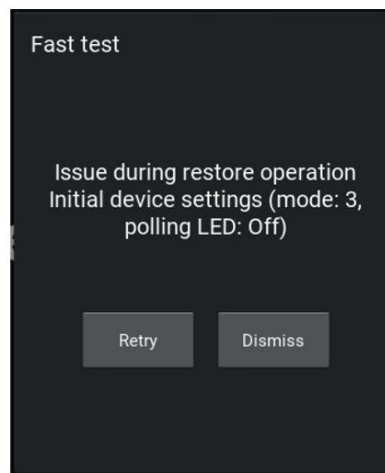

(b)

If the device successfully passes the data restore operation, the 'Data restored' splash screen (a) appears. If the data restore is not successful the 'Issue during restore operation' splash screen appears along with details of the initial device settings (mode, polling LED status).

Tap either 'Retry' or 'Dismiss' as appropriate.

'Retry' will start the test again.

'Dismiss' closes the Fast Test splash screen.

12.3 LED Test



To start the LED test, tap the LED test button. The button colour changes from grey to blue and the LED test is active.

12.4 Sensor status

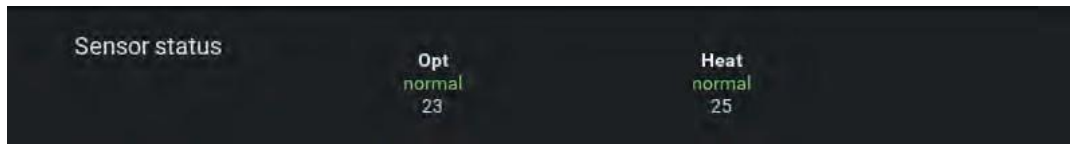

The Sensor status section of the programmer mode splash screen is divided into three rows:

- The top row shows the sensor type
- The middle row shows the last sensor status - the colour of the text indicates its current state:

Blue - Fault

Green - normal

Orange - active

Red - alarm

- The bottom row shows the raw sensor value - live temperature for a heat sensor, live optical sensor value or live CO sensor value.

12.5 Settings

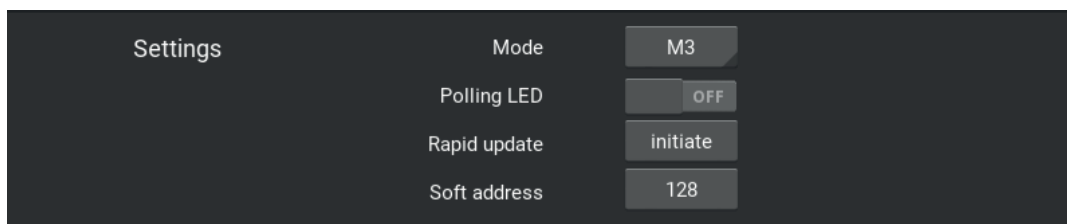

The Settings section of the programmer mode splash screen enables you to adjust the settings of a Discovery or Soteria device. The available options depend upon the type of device that is fitted to the mounting base.

12.6 Mode

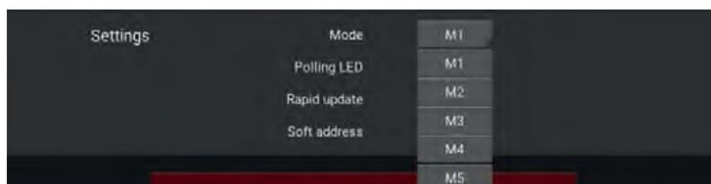

To change the device mode, tap the mode button. A drop-down list appears showing the available modes.

Tap the mode you require. The drop-down list closes and the selected mode is shown.

12.7 Polling LED



To change the polling status, tap the Polling LED button. The polling status is changed and the active status is highlighted blue.

12.8 Rapid update

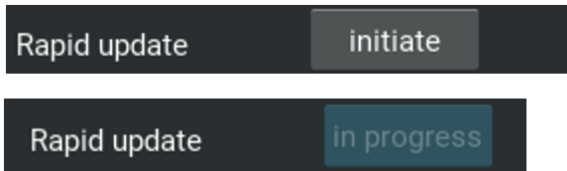

To start rapid update of the device, tap the 'initiate' button. The words 'in progress' appear, the colour changes from grey to blue and 'darkens' this means that its state cannot be changed during the update period - 30 seconds. When the update is finished the button colour returns to grey.

12.9 Soft address (function not available at present)



To change the address of a device, tap the 'Soft address' button. The numeric keyboard splash screen appears.



Tap in the new soft address for the device.

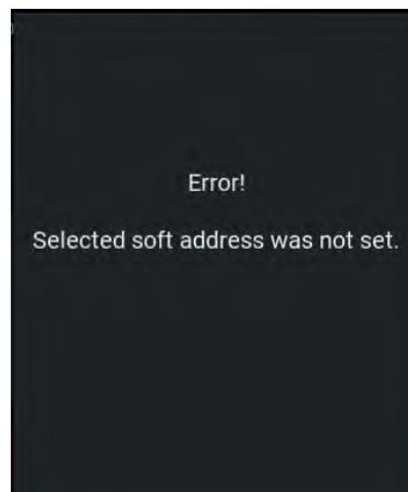
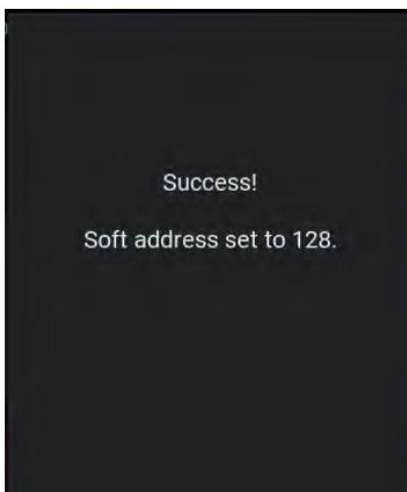

The splash screen then changes to show either a 'success' or 'Error' message.

Success - shows that the new address has been set.

Error - new address has not been set. This could be that the address is already assigned, not available on the loop or is incorrect.

12.10 Restore to factory defaults

This button restores a Discovery or Soteria device to its factory defaults. Remember that if you use this option, all non-volatile memory including the soft address will be reset.

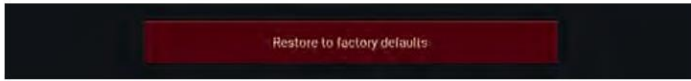

Tap the 'Restore to factory defaults' button. A warning splash screen appears.

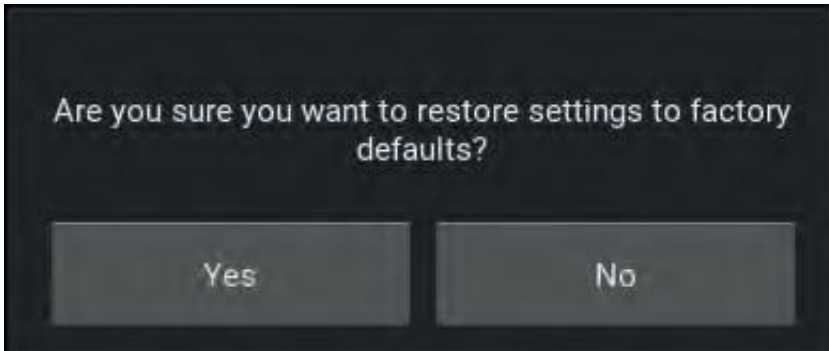

If you want to proceed with the reset, tap 'Yes'. The reset is started. The splash screen closes when it is complete.

If you don't want to reset the device, tap 'No'. The reset is not done and the splash screen closes.

12.11 Sounders

Additional fields become available if a sounder is connected to the Test Set in Programmer mode.

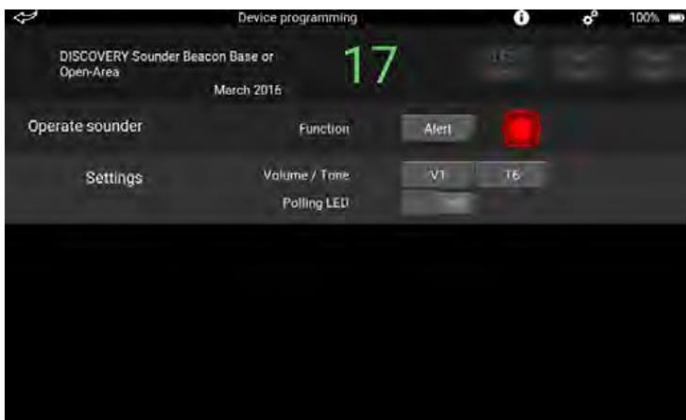

Two sounder functions are available, alert and evacuate.



Tap 'Alert', a drop-down appears that enables you to choose between the alert and evacuate functions.



Tap and hold the sounder icon. The sounder will operate until you remove your finger from the icon.

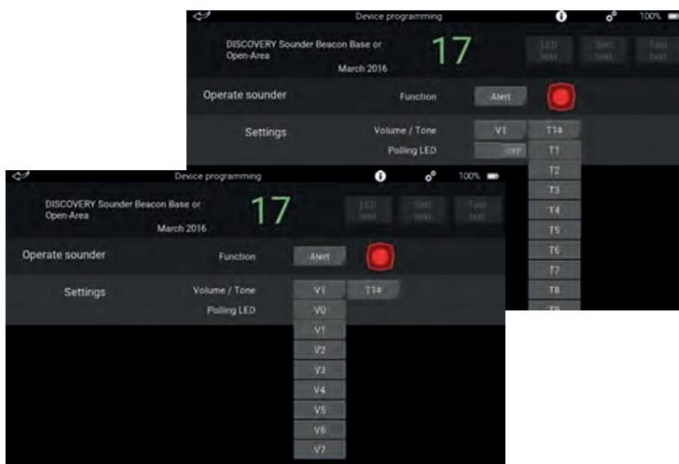

Tap the volume button, a drop-down appears. Tap to select the required volume level.



Tap the tone button, a drop-down appears. Tap to select the required tone.



To test the selected tone and volume, tap and hold the sounder icon. The sounder will operate until you remove your finger.

12.12 Operate relays

The Operate Relays field is available if an Input/Output Module is fitted to the test set unit. The number of switches available are equal to the number of relays which depends upon the device type.

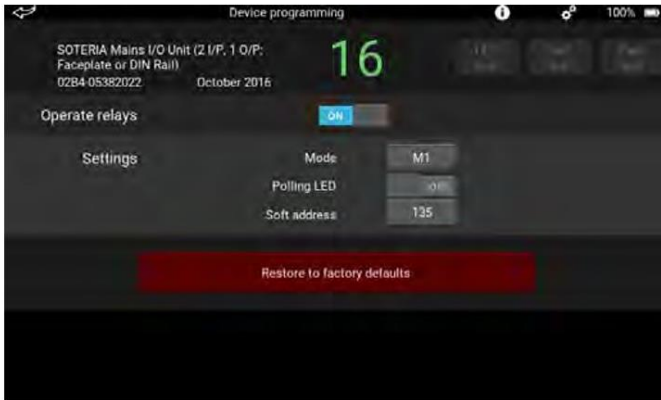

To change the status of a relay, tap the 'Operate relays' button. When the relay is enabled the button colour changes from grey to blue.



The relay settings are change by tapping the button of the setting to be changed. Tap 'Mode' a drop-down appears. Tap to select the required mode. Changing the soft address is detailed on page 23.

13 How do I use Loop diagnostics?

Loop diagnostics provide:

- Wire connection test
- Short circuit fault test
- Earth fault test
- Loop voltage and current measurement
- Loop cable impedance measurement
- Automatic detection of earth fault location

These tests and measurements are divided into four groups:

- Short circuit fault/earth fault detection
- Loop supply - from OUT - voltage and current measurement
- Loop supply - from IN - voltage and current measurement
- Earth fault location search

The pages that follow give a brief overview of each of the loop diagnostics procedures. For full details, please refer to Appendices A to E on pages 43 to 47.

Short circuit fault/earth fault detection

This is the core test of loop diagnostics. It shows the results of the wire connection test, short circuit fault test, earth fault test and loop cable impedance measurement.

It is a step-by-step process, which means only the first detected fault is shown; the Test Set then stops any further testing. Testing is not resumed until the appropriate on-screen button is selected.

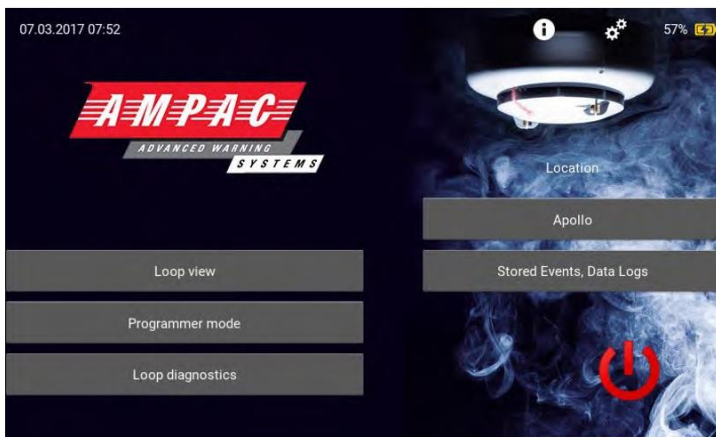

To start the short circuit fault/earth fault detection test:



On the Home Screen, tap the 'Loop diagnostics' tab. The loop diagnostics screen appears.

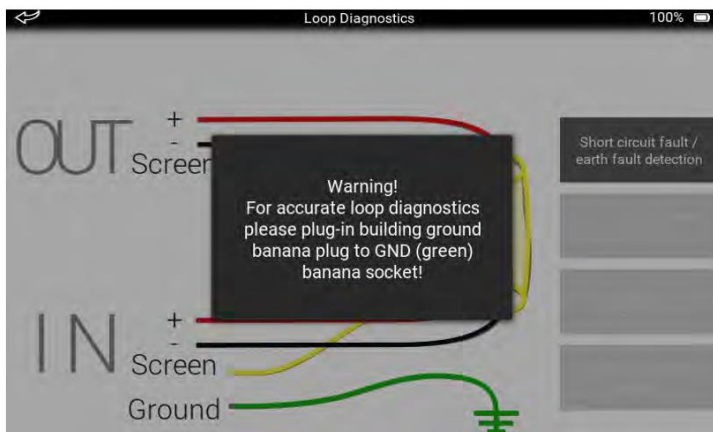

A warning splash screen appears requesting that the building ground banana plug should be plugged into the GND banana socket on the Test Set.

After doing this, tap the screen and loop diagnostics will start.

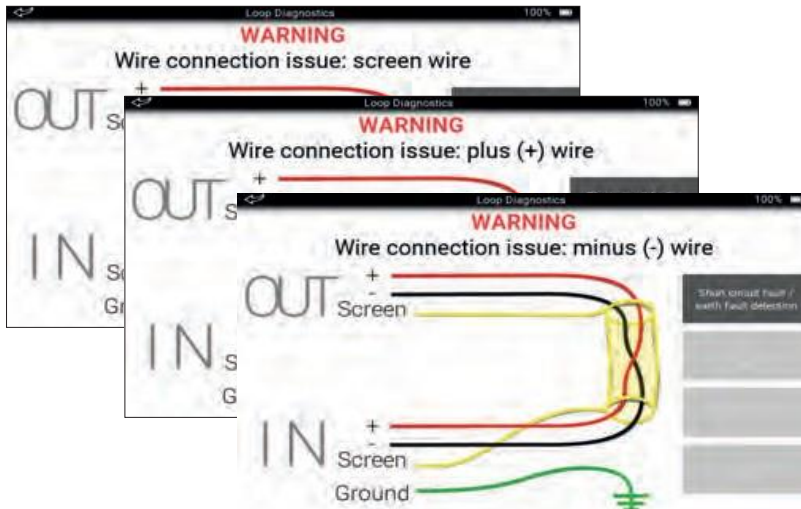

The first thing tested is the loop integrity.

If there is a broken wire or it is not plugged into a socket, a warning message 'Wire connection issue' appears below the top bar.

In addition it will tell you which wire is carrying the fault. The message will continue as appropriate with one of these statements:

'screen wire' 'plus (+) wire'

'minus (-) wire'

The fault should be investigated and corrected before continuing.

The grey box on the right of the schematic shows what test is being done.

13.1 Short circuit fault

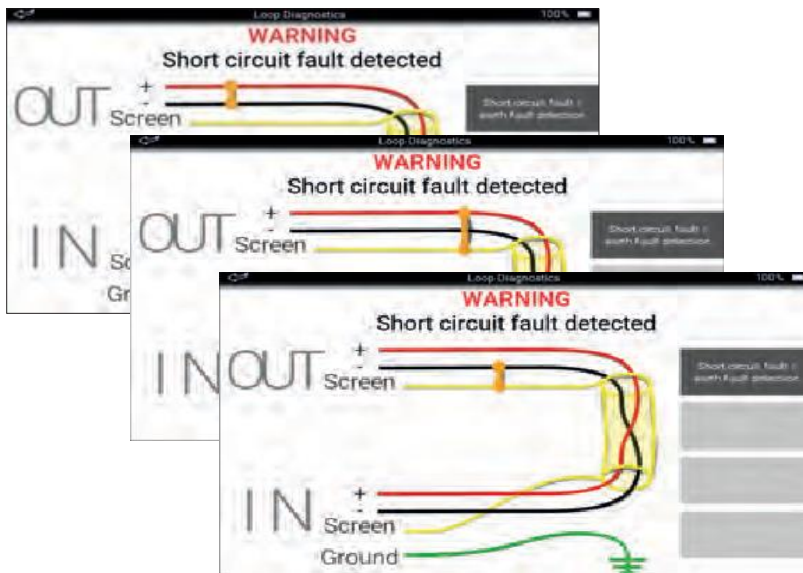

If a short circuit fault is detected between;

'+ and -'

'+ and screen'

'- and screen'

A warning message 'Short circuit fault detected' appears below the top bar and a bold orange connection line is shown between the two affected wires.

The fault should be investigated and corrected before continuing.

13.2 Earth fault

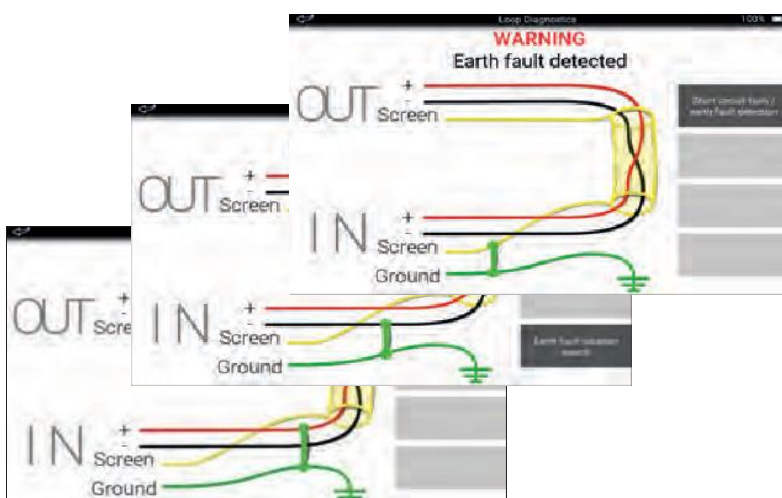

If an earth fault is detected between:

'+ and GND'

'- and GND'

'Screen and GND'

A warning message 'Earth fault detected' appears below the top bar and a bold green connection is shown between the two affected wires.

The fault should be investigated and corrected before proceeding.

13.3 Cable impedance and cable run

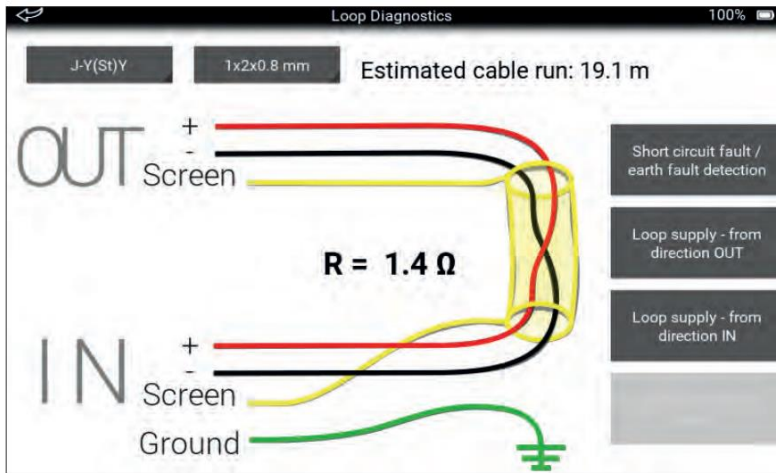

When a cable run is between one and 4178 metres, cable impedance and cable run values are shown on the screen.

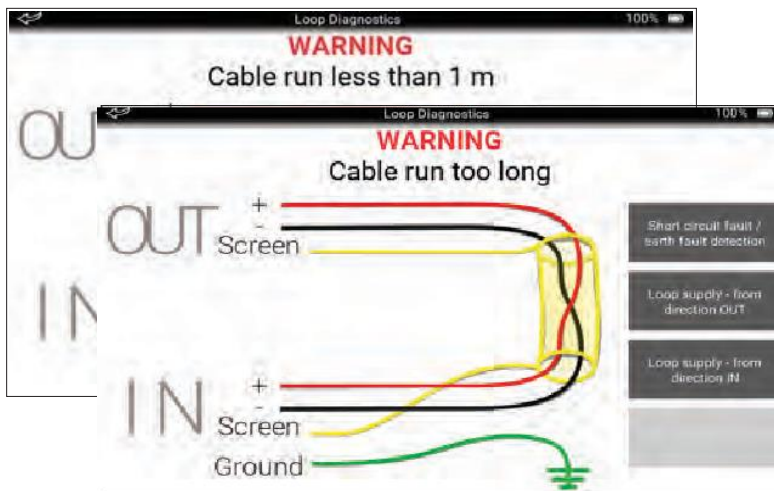

If the cable run is either less than one metre in length, or, more than 4178 metres a warning message appears below the top bar.

13.4 Loop supply - from direction OUT

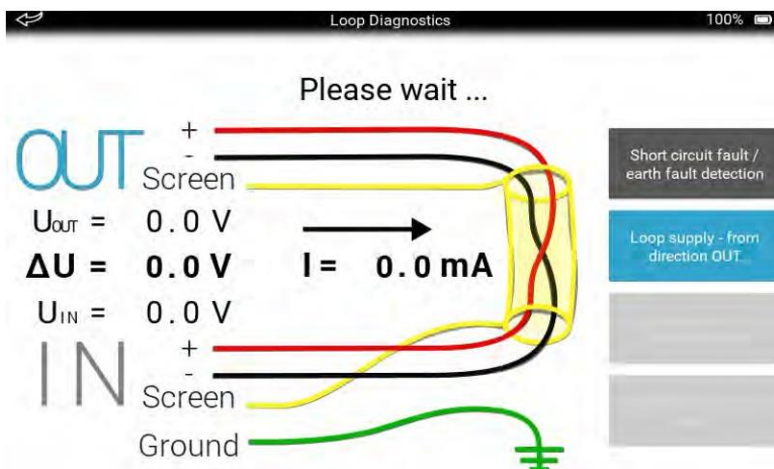

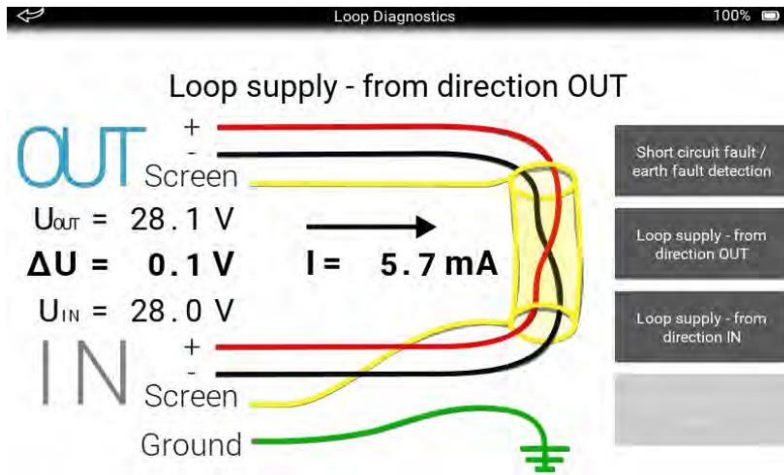

Loop supply measurements are only possible if there are no faults on the loop. The loop is supplied with 28 V dc from OUT, coloured blue on-screen. The voltage is measured on the IN side, with the direction of current flow from OUT to IN. The screen also shows the difference between the OUT and IN voltages.

13.5 Loop supply - from direction IN

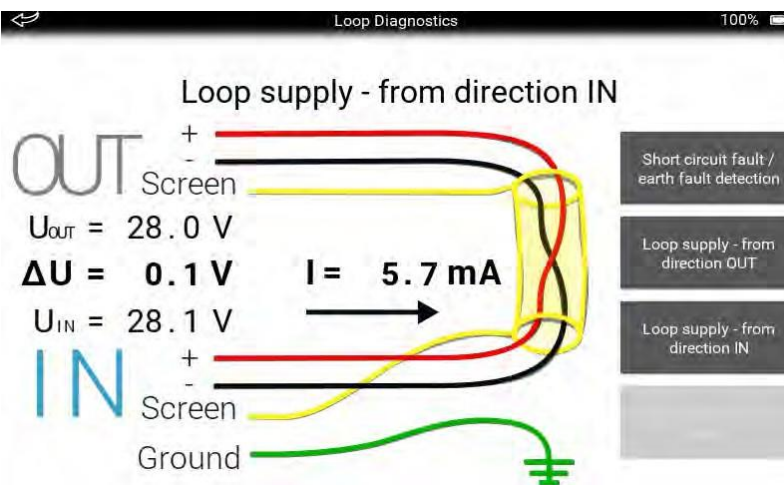
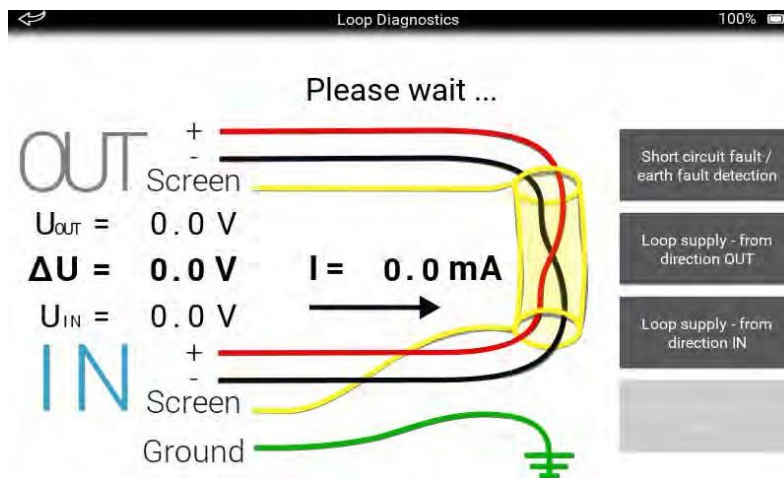

Loop supply measurements are only possible if there are no faults on the loop. The loop is supplied with 28 V dc from IN, coloured blue on-screen. The voltage is measured on the OUT side, with the direction of current flow from IN to OUT. The screen also shows the difference between the OUT and IN voltages

Earth fault location search

The earth fault location search for the automatic detection of the earth fault location on the negative loop conductor can only be done on a Soteria system with isolators. It can also only be done under certain conditions, that is, when all connections are good and there is no short circuit between the loop plus and minus wires.

The earth fault location search is made up of three steps:

1. Occupied addresses search
2. Loop devices map building
3. Earth fault location search

13.6 Occupied address search

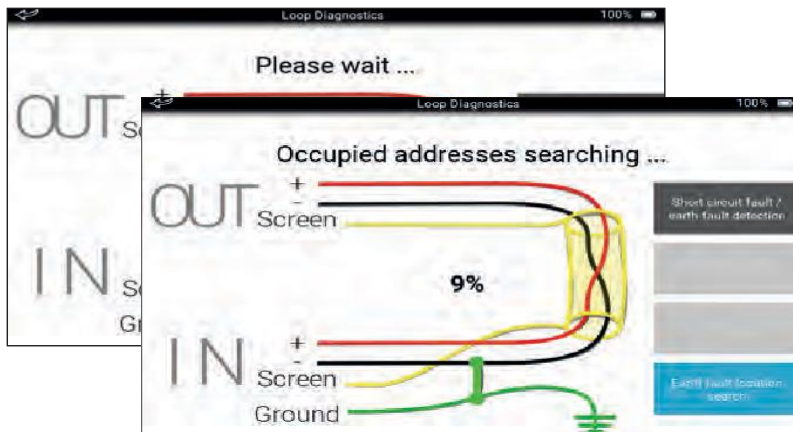
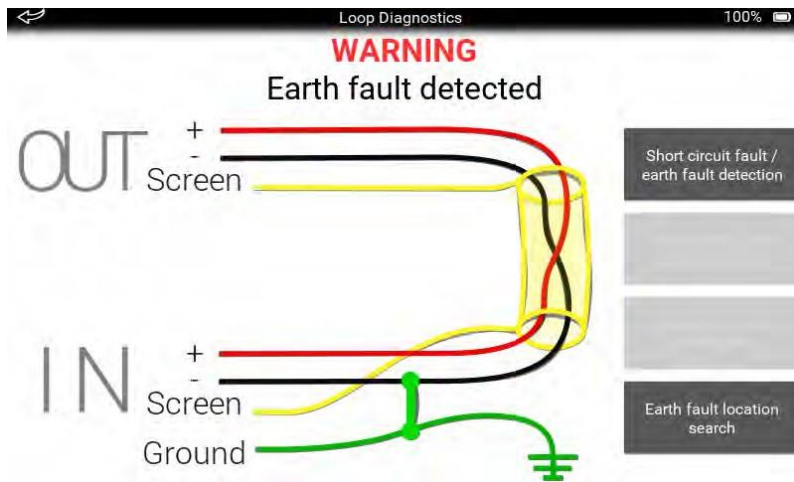

In the occupied address search, the device polls all 254 addresses. The progress is shown as a percentage on screen.

A list of occupied addresses is produced, but if there is an issue such as an empty loop, legacy device, non-isolated device or dual address, the search stops and a warning is shown.

13.7 Loop devices map building

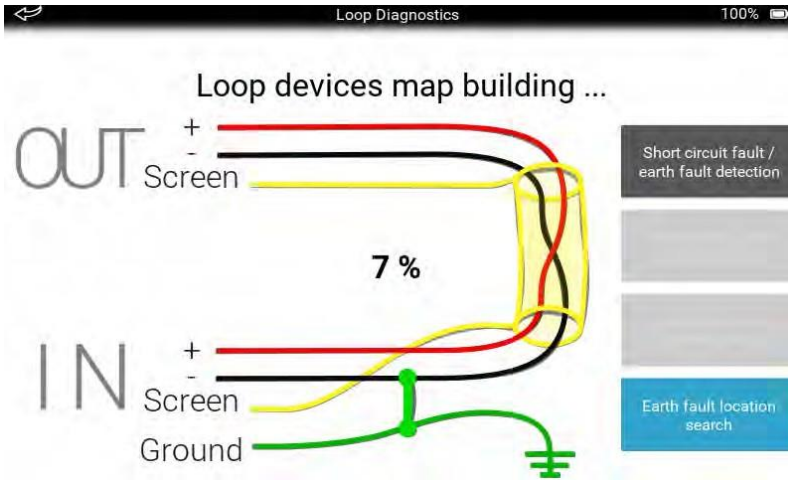

Loop devices map building function uses the Soteria isolator function to break the loop and sort.

It then sorts the addresses into an 'as fitted' order. Progress is indicated as a percentage, but if there is an issue the process stops and a warning is shown.

13.8 Earth fault location search

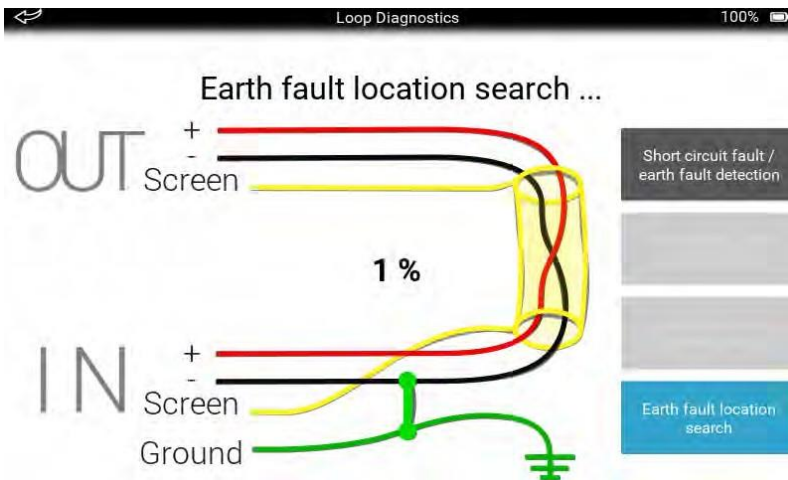

In this process, the Soteria isolator control function and the earth fault test are used to detect and report where a fault is. Progress is shown as a percentage on screen.

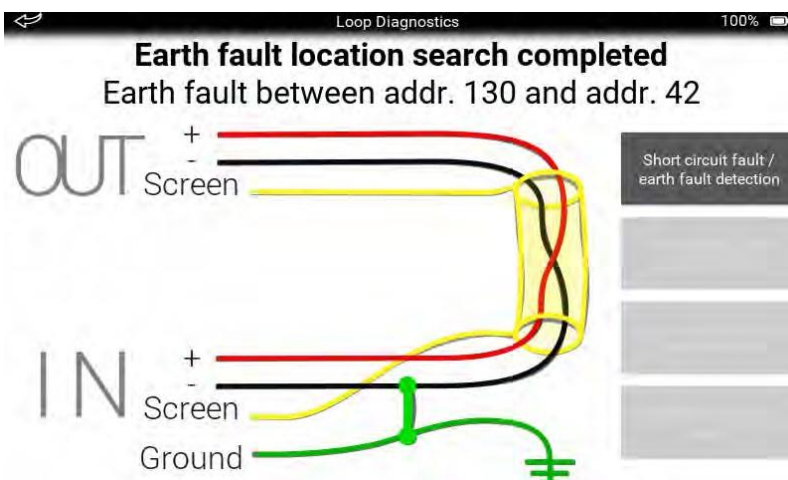

If there is an earth fault detected in a single location. The result is shown as a location between two addresses.

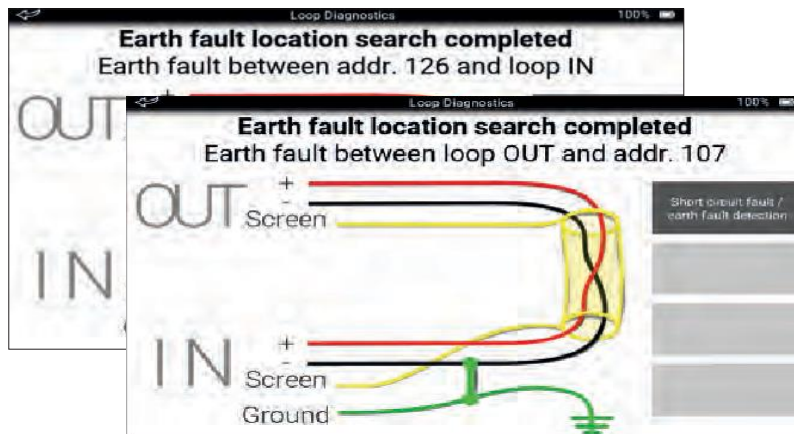

If there is more than one earth fault detected, the result is shown as either between an address and the IN loop, or between an address and the OUT loop. To find the fault you should check the loop back from the address that is given.

14 How do I enter a location?

The Location function enables you to enter a location where a test has been done.

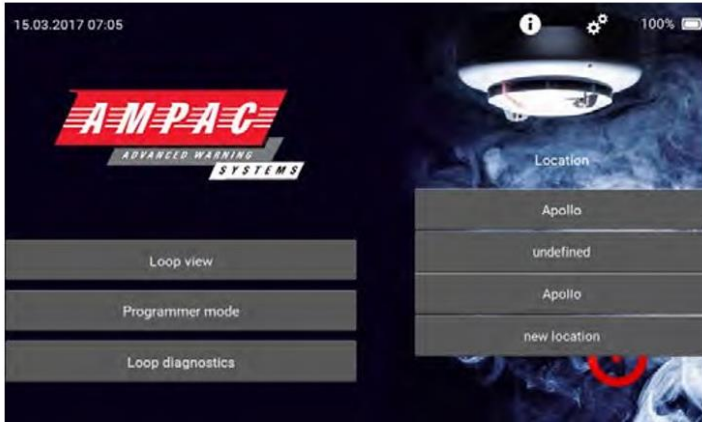

To enter a location, on the home screen tap the 'Location' tab. This is the tab immediately below 'Location' on the home screen. A drop-down appears listing all the locations.

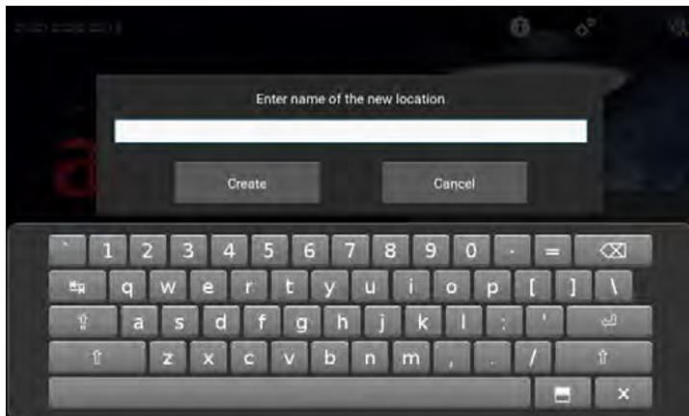

Either tap an existing location, or 'new location', an on-screen keyboard appears.

Type in the name of the new location and tap 'Create'. The on-screen keyboard closes and a tab with the new location appears in the drop-down.

When a location is added, the Stored Events, Data logs tab becomes available for that location.

15 How do I use Stored Events , Data logs?

If a location is entered on the Test Set, the Stored Events, Data logs tab becomes available.

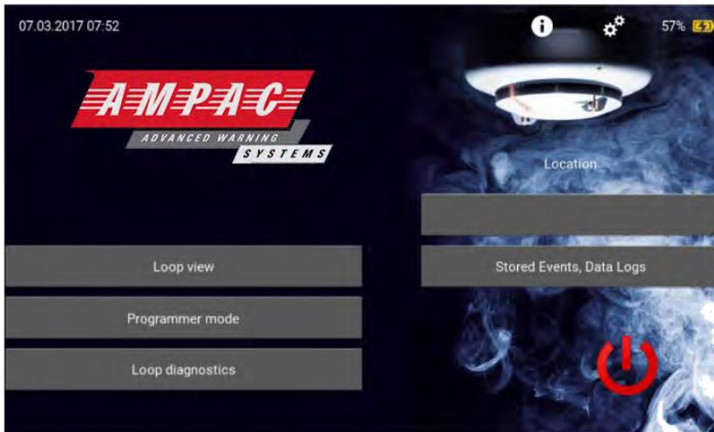

Tap the 'Stored Events, Data Logs' tab. The stored data and events screen appears.



Tap the report that you want to see in detail. The message 'Loading in progress' appears, followed by the report screen.

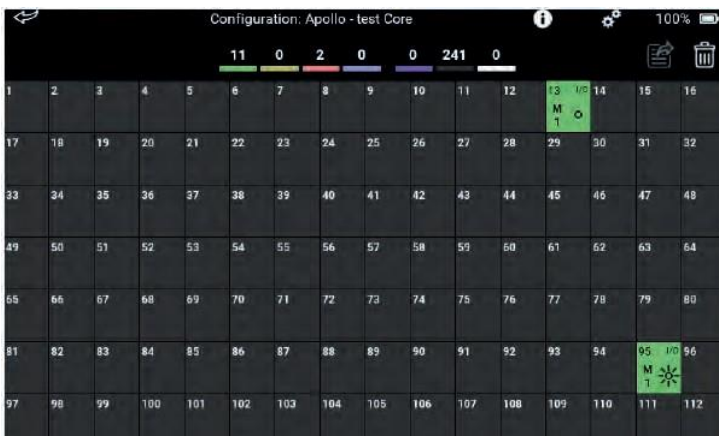

When you have finished with the report, there are now two choices:

- 1.The report can be deleted
- 2.The report can be exported to a USB flash stick as a .csv file.

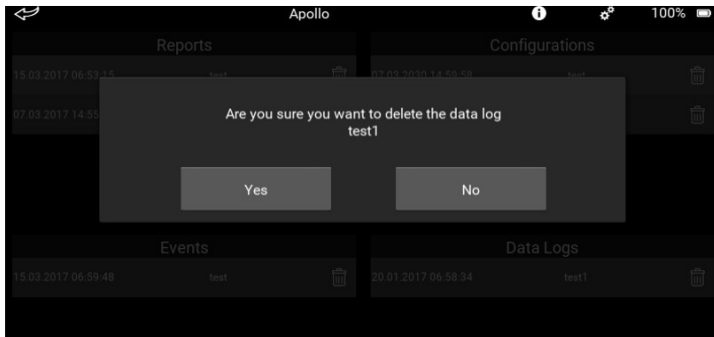

To delete the report:



Tap the dustbin icon. A splash screen appears asking you to confirm the deletion.



Tap 'Yes' to delete the report, tap 'No' to return to the report screen.

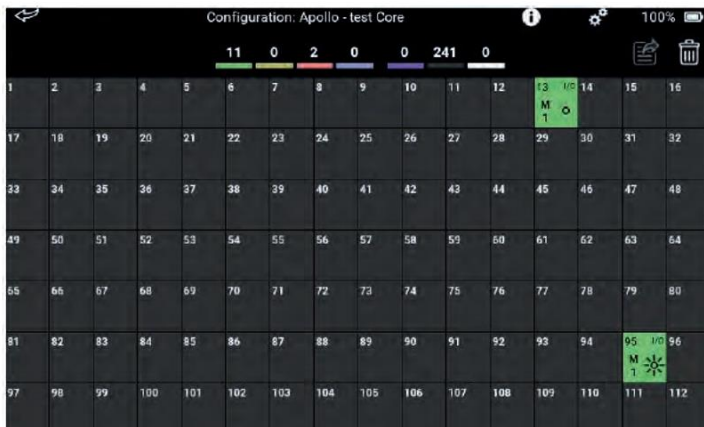

To export the report onto a USB device as a .csv file:

1. Insert a USB flash stick into the USB slot on the side of the Test Set. The export icon is highlighted.



2. Tap the highlighted icon. The on-screen keyboard appears.

3. Enter the file title and tap 'Export'

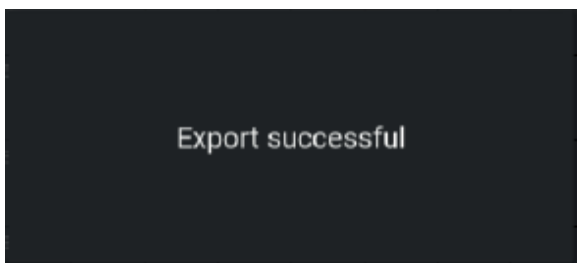

When the file has been exported a splash screen appears showing the export has been a success.

Tap the back arrow to return to the Home page.

16 How do I update firmware?

To make sure that the Test Set operates efficiently, it may be necessary to update the firmware that operates it. Firmware updates will be made available on www.ampac.net and will require loading onto a USB flash drive.

To install the firmware update:

1. Connect the power supply cable to the Test Set and a suitable power supply.
2. Plug the USB flash drive containing the firmware update into the USB socket of the Test Set.
3. Make a note of the firmware update version number.

The full Firmware Update flowchart can be found on page 47.

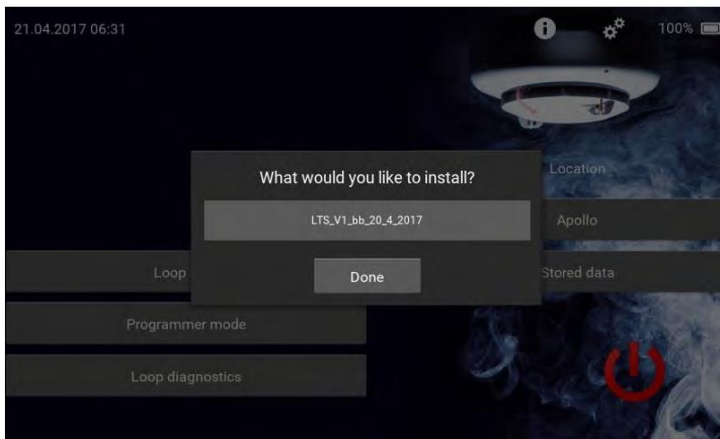

The firmware update screen appears. Tap the update to be installed.

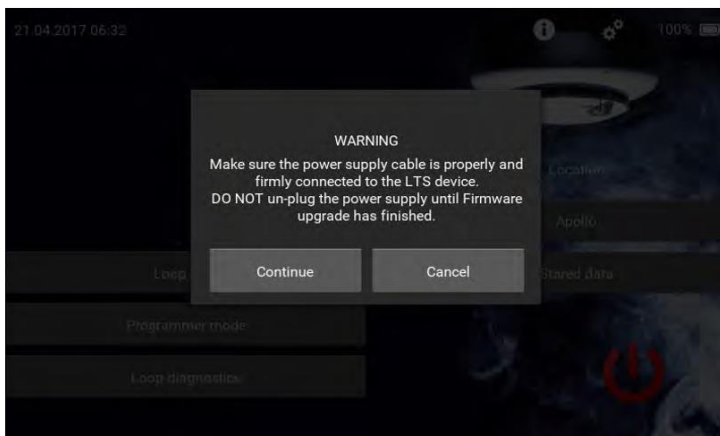

The Warning splash screen appears. Check that the power supply cable is correctly attached to the Test Set and tap 'Continue'.

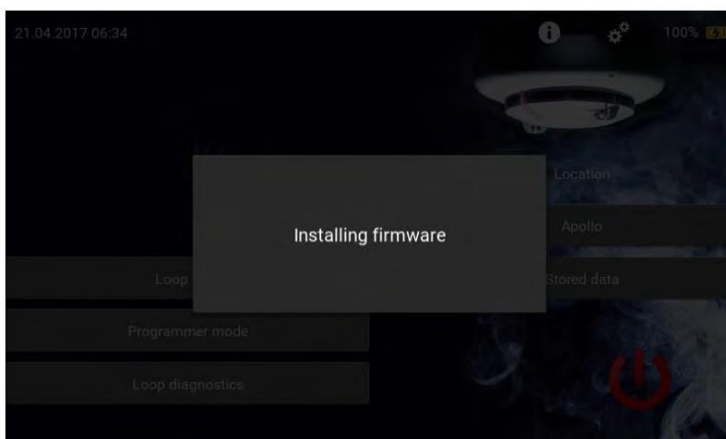

The 'Installing firmware' screen appears. DO NOT do anything with the Test Set during the update process.

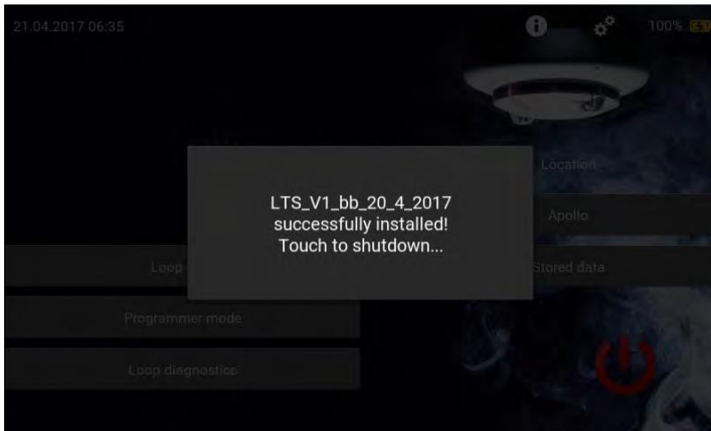

When the Firmware Update has finished uploading, the 'Successfully Installed' splash screen appears. Tap the splash screen. The Test Set powers off.

Restart the Test Set and check that the firmware has updated and the correct version has been installed. The version number can be checked by tapping the 'Settings' icon.

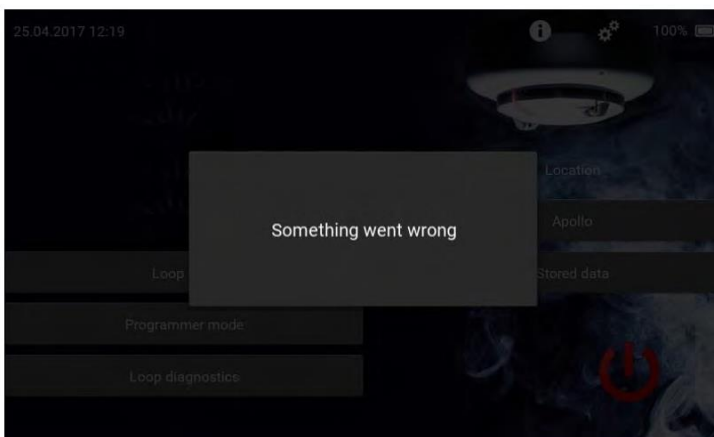

If something goes wrong during the update procedure, the message 'Something went wrong' appears.

If this happens it will be necessary to install the last stable version from the list of updates. Until the stable version is installed all menus and sub-menus (except firmware update) are disabled.

The last stable firmware update version can be found at www.ampac.net This stable version should be downloaded onto the USB flash stick and the firmware update procedure repeated using this stable version.

17 Troubleshooting

This section contains a list of potential problems and their solutions.

Q. I have pressed and held the power-on button, but the Test Set has not powered on.

A. If the power LED is illuminated, try a hard reset. If it still does not work, contact Ampac Technical Support.

Q. When I connect the charger the orange LED does not light to show it is connected.

A. a) If the charger is connected and the LED is green - the Test Set is fully charged.

b) If the LED is red or off - check the charger is plugged into the mains supply and correctly connected to the Test Set. If the LED still does not light, replace the charger.

Q. The warning message 'ERROR An internal error occurred! (001)'

A. There has been an internal communication error. The Test Set should reset and the Home Screen appear. If this happens repeatedly, try a hard reset. If this does not solve the problem, please contact Ampac Technical Support.

Q. When I open a Menu or sub-menu the Test Set does not poll or show results in Loop Diagnostics.

A. Try a hard reset, if this does not work contact Ampac Technical Support.

Q. Instead of information about a device, its type, range or description, I see either a question mark or NA. Why is the information not shown?

A. A question mark or NA appears if the device type is not recognised, meaning it is not included in the list of devices. Please provide the device information to Ampac Technical Support.

18 How do I do a hard reset?

If your Test Set is running slow, freezing, not responding or responding incorrectly, you should do a hard reset. Press and hold the Power button for approximately eight seconds, until the power LED is lit. The device will then shut down. You will then need to restart it.

19 How do I replace the battery pack?

A replacement lithium-ion battery pack, Part No. 29600-795 (Ampac Test Set Battery) is available from Ampac. To replace the battery pack:

1. Power-off the Test Set.
2. Loosen the screw on the battery compartment cover.
3. Remove the battery compartment cover.
4. Carefully remove the battery from its compartment.
5. Unclip the battery connector and dispose of the battery.
6. Clip the new battery connector in place - make sure the cable is the right way around.
7. Insert the new battery into the battery compartment.
8. Refit the battery compartment cover and secure in place using the screw.



Do not dispose of batteries in domestic waste. Correct disposal is necessary for safety and environmental reasons.

20 Appendix A - Menu tree

The test set menu tree is constructed as follows:

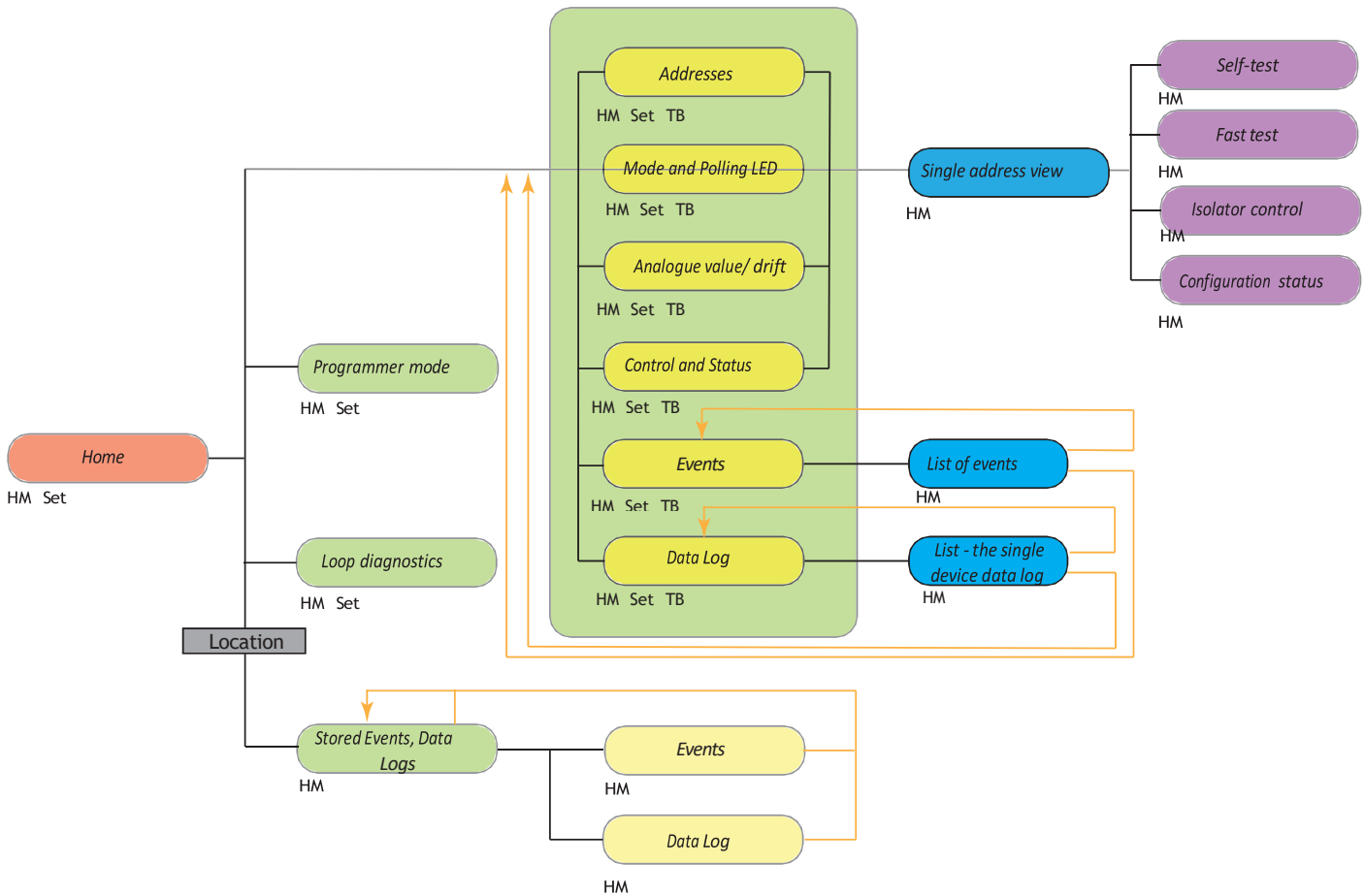

21 Appendix B - Short circuit and earth fault detection flowchart

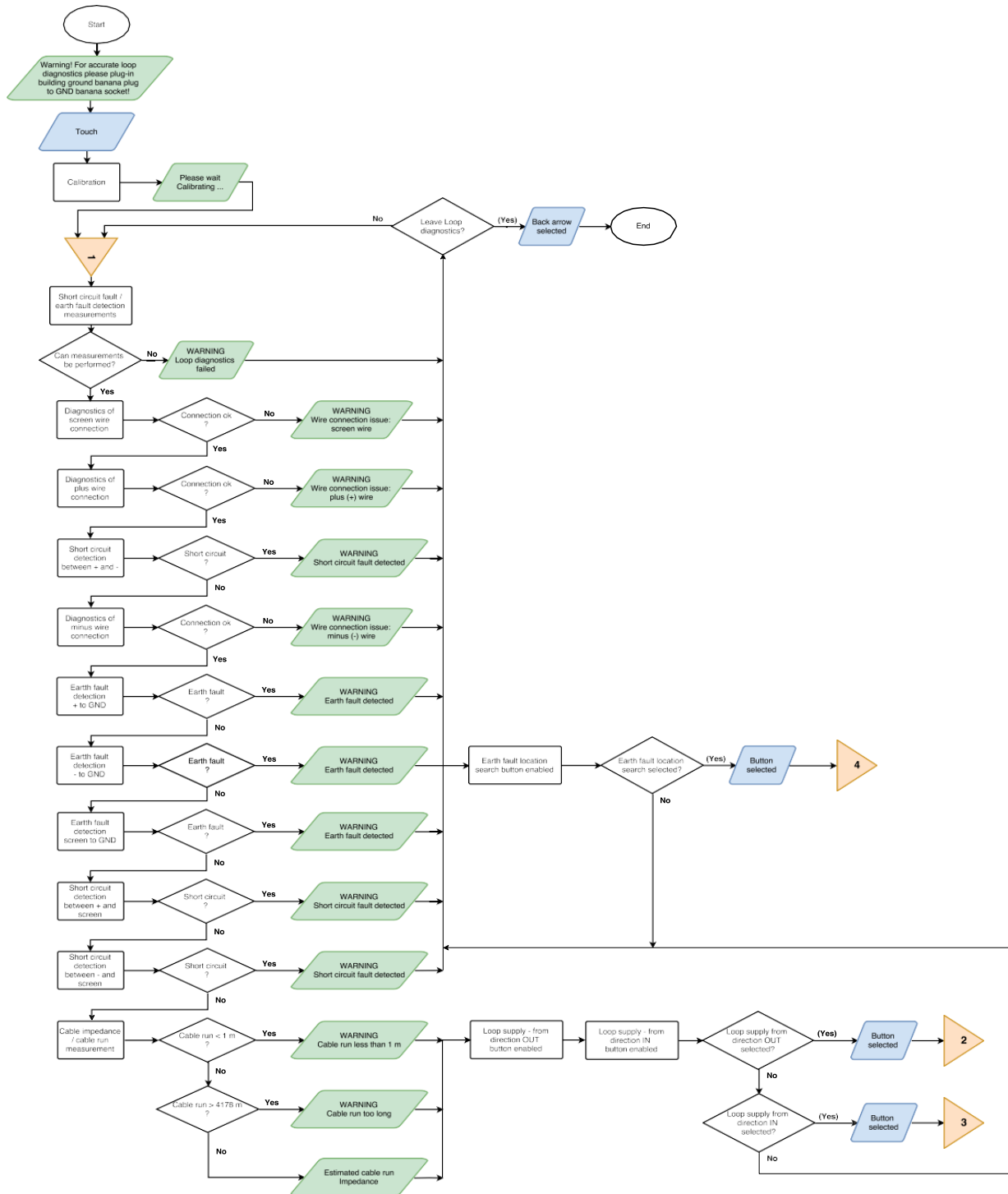

22 Appendix C - Loop supply from direction OUT

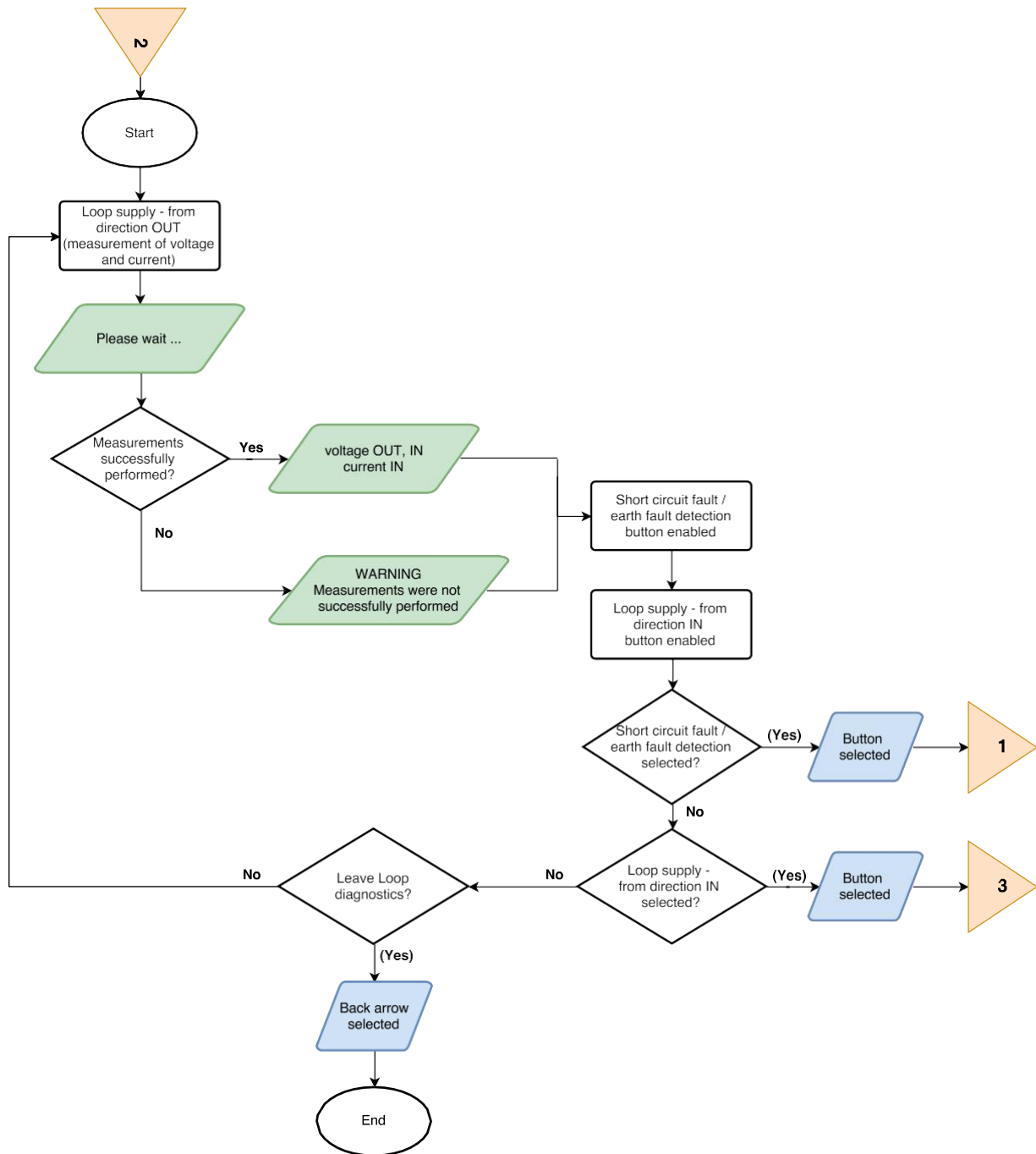

23 Appendix D - Loop supply from direction IN

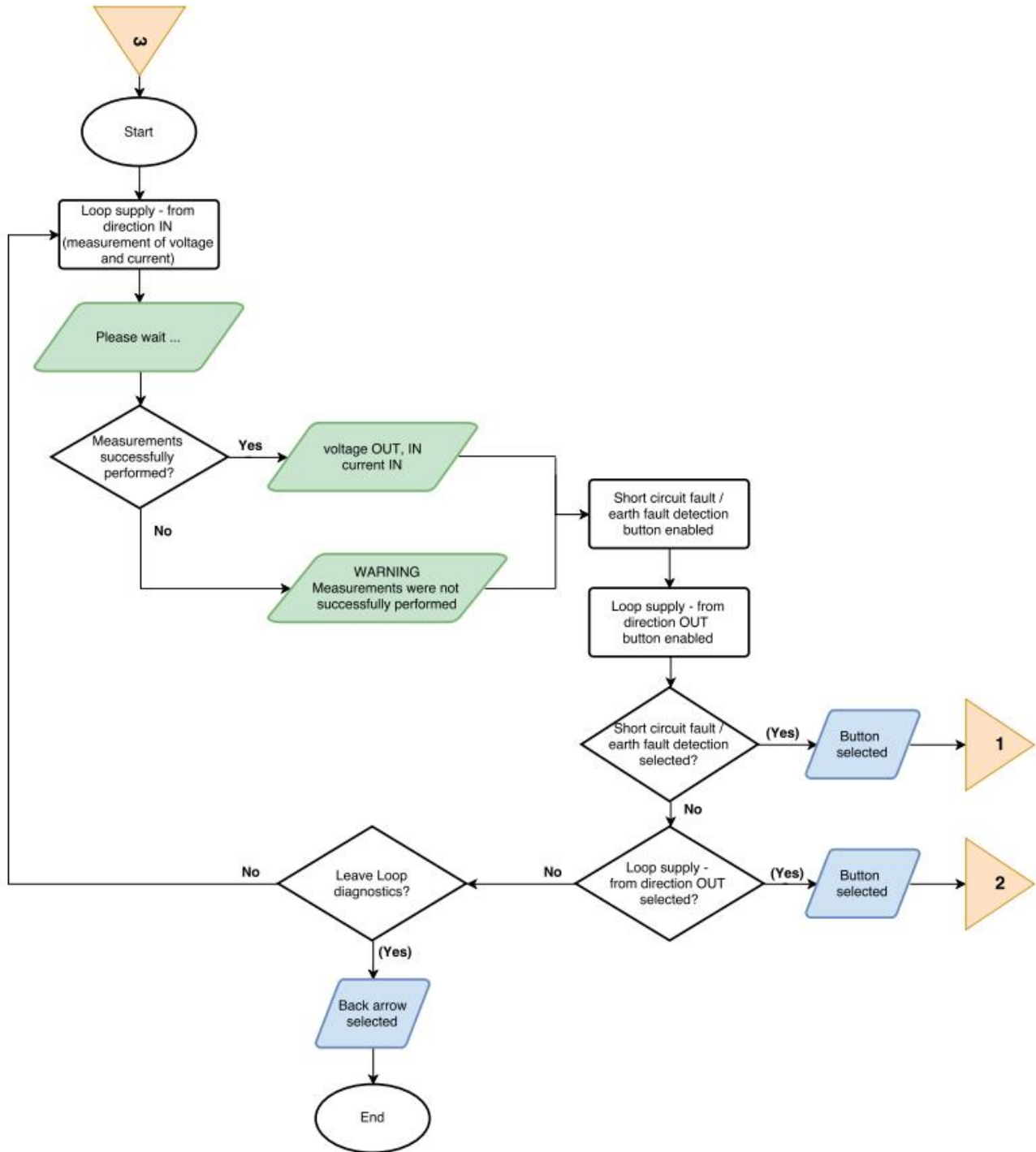

24 Appendix E - Earth fault location search

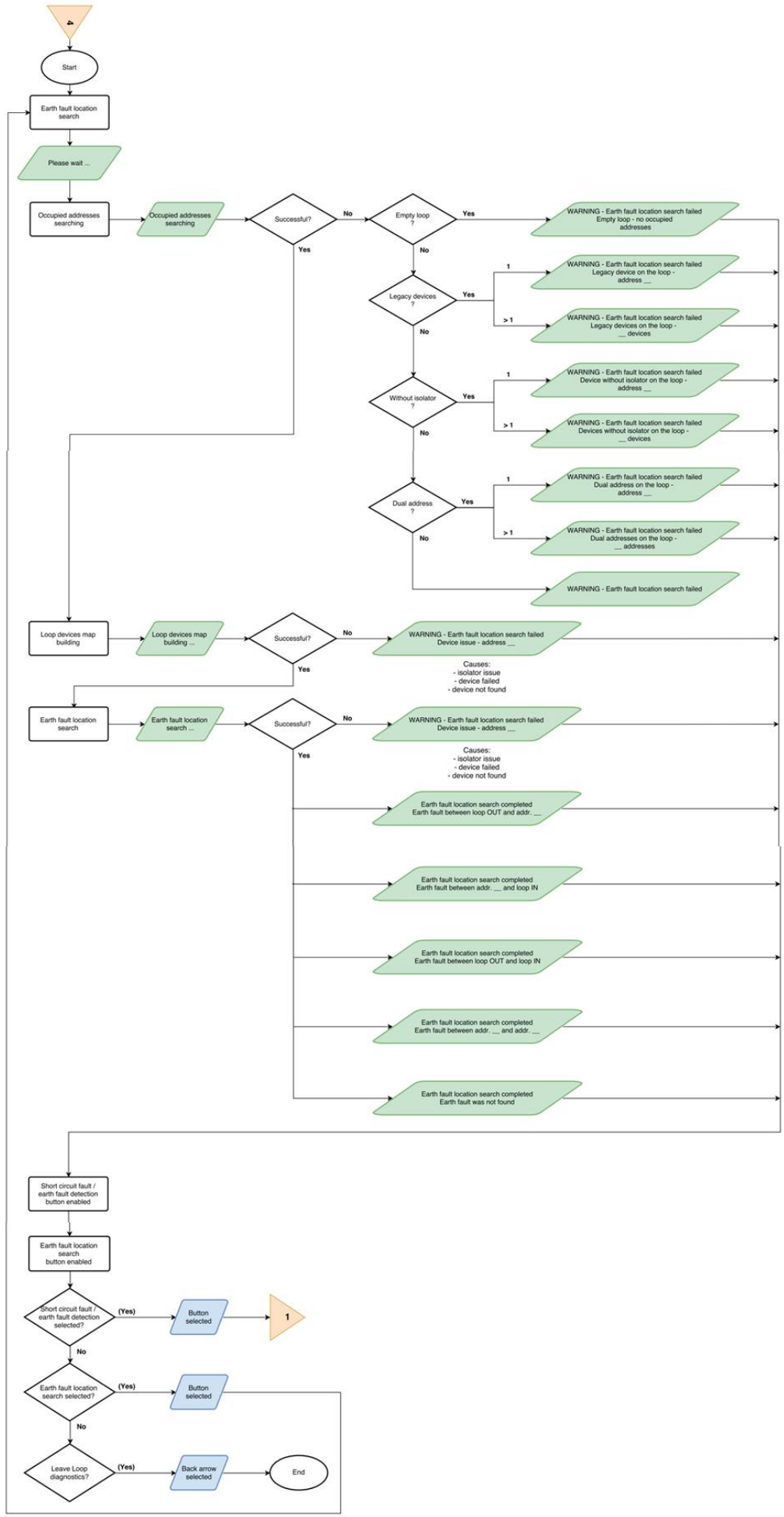

25 Appendix F – Firmware update

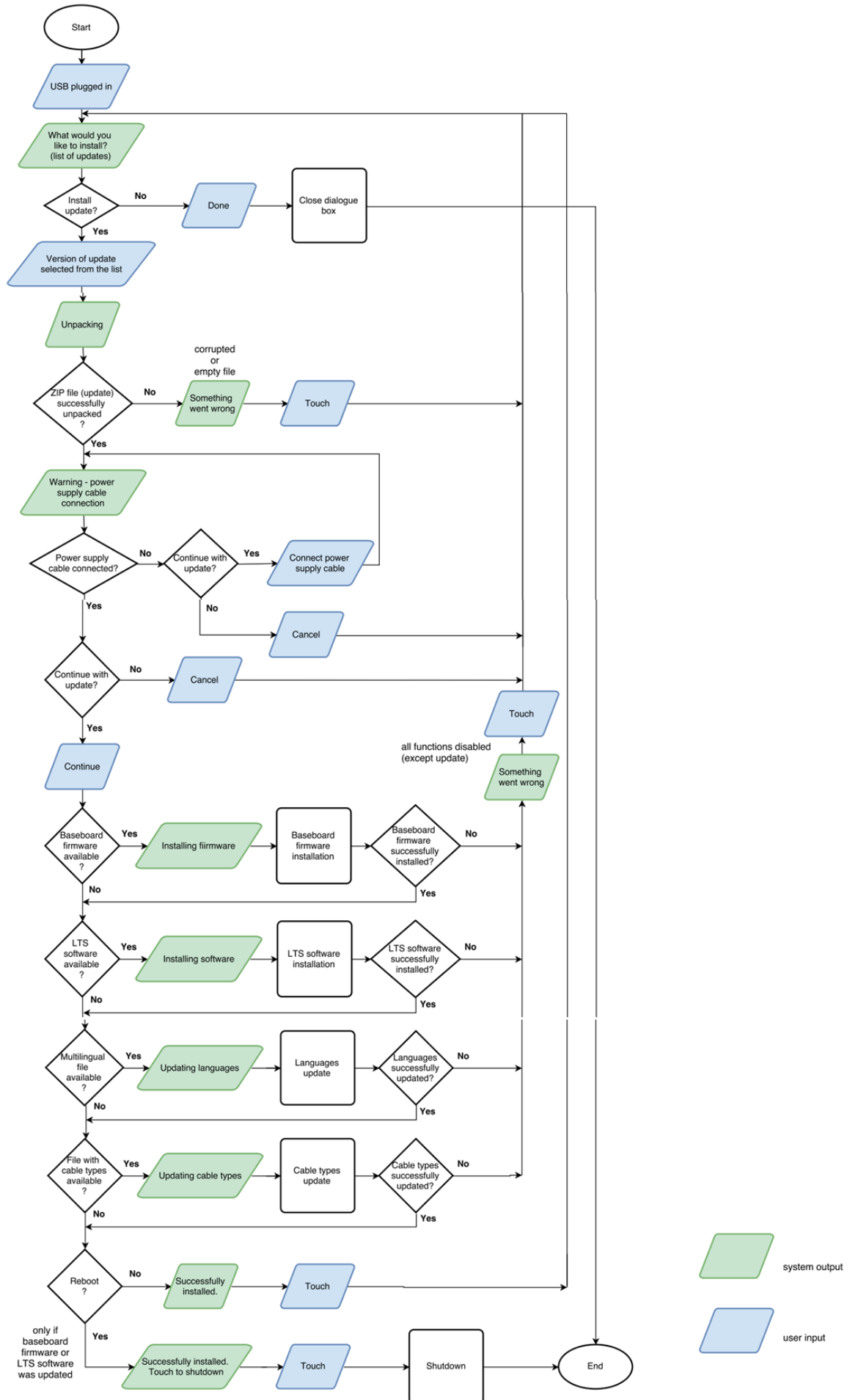

26 Appendix G – Line Voltages

Menu	Home screen	Loop view		Loop diagnostics	Programmer mode
Voltage					
35 V					
28 V					
0 V			DEFAULT		
	without line voltage	without line voltage	XP/Dis protocol line voltage CoreProtocol line voltage	full CoreProtocol line voltage	max 28 V CoreProtocol line voltage
Can user change the line voltage?	✗	✓	✓	✓	✗

