



ADVANCED WARNING

SYSTEMS

# FireFinder PLUS



## Fire Alarm Control Panel (NZS4512:2010)

## Installation, Commissioning & Operation

**MAN 2996-2**

WORLD LEADER OF INNOVATIVE SOLUTIONS  
IN FIRE DETECTION AND ALARM SYSTEMS

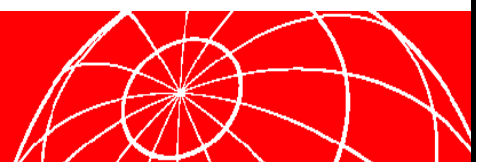

## Responding to a Fire

### Access Level 1

The  and  indicators will be illuminated

The  button is pressed to override any delays to outputs

The  button is pressed to silence the buzzer



Activating the “SILENCE ALARMS. BRIGADE USE ONLY” Key will silence all Alarm Outputs.

### Access Level 2

The  button is pressed to turn ON all alarm devices.

The  button is pressed to silence any silence-able outputs that have been activated.

The  will be illuminated to indicate that the silence-able outputs have been silenced and resound is available.

The operation of the SILENCE button will be logged.

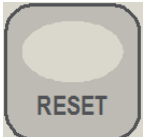
The  button is pressed to reset the fire condition. All outputs activated in response to the fire will deactivate and the panel will revert to the normal condition providing there are no other abnormal conditions present. – RESET IS LOGGED.

## Disabling a Zone / Device

### Access Level 2

The following example DISABLES a ZONE.

Place the Keyswitch in the ENABLED position.

Press  then Press  for Zone 1 selection.

```

FIREFINDER          17/12/2012 09:00:00
ZONE:1
SELECT ZONE NO. THEN TO OR DISPLAY OR
DEVICE DISABLE/ENABLE KEY
AC:2Z  ALM:0  PALM:0  FLT:0  DIS:0
    
```

Now Press the .

The Disable LED will illuminate  and the following screen will displayed

```

Loop 1 Sensor 1                      MCP
L1 D1 Z1
STAT:NORMAL                          /DISB
ZONES DISABLES 1 of 1
AC:2Z  ALM:0  PALM:0  FLT:0  DIS:1
    
```

# TABLE OF CONTENTS

Page No.

<b>1</b>	<b>About This Manual .....</b>	<b>1</b>
1.1	Introduction .....	1
1.2	General Requirements.....	1
1.3	References.....	1
1.4	Symbols .....	1
<b>2</b>	<b>Introduction.....</b>	<b>2</b>
2.1	System Overview .....	2
2.2	Overview & Key Features .....	2
2.3	FACP Configuration Examples .....	3
<b>3</b>	<b>FireFinder Plus Description .....</b>	<b>4</b>
<b>4</b>	<b>Placing The Basic System Into Operation .....</b>	<b>6</b>
4.1	Unpacking .....	6
4.2	Anti-Static Precautions.....	6
4.3	Working On The System.....	6
4.4	The Cabinet.....	6
4.5	Cable Types and Limitations.....	7
4.6	Power Supplies and AC Mains Installation .....	7
4.6.1	Connecting the Mains Earth .....	7
4.6.2	Connecting Power Supply .....	8
4.7	CORRECT Power Up / Turn "ON" Procedure .....	8
4.8	Brigade / PSU Monitor Board.....	9
4.8.1	Battery Connections .....	11
4.8.2	Auxiliary 27 Volt Power.....	11
4.8.3	Monitored Inputs .....	12
4.8.4	Monitored Outputs .....	13
4.8.5	Relay Output Connections.....	14
4.9	High Current Interface Board .....	15
4.10	Main Board.....	16
4.11	Front Panel Board .....	17
4.12	Main CPU.....	18
4.13	Slave CPU.....	19
4.14	Addressable Dual Loop Termination Board .....	20
4.14.1	Detector loop Isolator Installation .....	21
4.14.2	Loop Isolator calculator .....	21
4.14.3	Loop Open / Short Circuit.....	21
<b>5</b>	<b>FireFinder PLUS Control Panel.....</b>	<b>22</b>
5.1	System Controls.....	22
5.2	System Indicators .....	25
<b>6</b>	<b>Functions And Menus.....</b>	<b>26</b>
6.1	The Default LCD Display .....	26
6.2	LCD Contrast .....	26
6.3	Accessing Functions and Menus .....	26
6.4	Function Menu and Access Levels .....	27
6.4.1	Forgotten Passwords.....	27
<b>7</b>	<b>The Main Menu.....</b>	<b>28</b>
7.1	Alarms .....	28
7.2	Stage 1 Alarms.....	28
7.3	Pre-Alarms .....	29

7.4	Faults .....	29
7.5	Disables .....	30
7.6	Walk Tests .....	30
7.7	Status .....	31
7.8	Tools .....	35
7.9	Setup .....	35
7.10	About .....	36
<b>8</b>	<b><i>The Function Menu .....</i></b>	<b>37</b>
8.1	Date .....	37
8.2	Time .....	37
8.3	Day/Night .....	38
8.4	Logs .....	38
8.5	TESTS .....	39
8.6	I/O .....	40
8.7	Global (Network Panels) .....	41
8.8	Passwords (Level III) .....	42
8.9	Programming .....	43
8.9.1	Conv (Conventional) Zone .....	43
8.9.2	Device .....	44
8.9.3	Input .....	45
8.9.4	Output .....	45
8.9.5	Panel Based MCP .....	45
8.9.6	Sub Address .....	45
8.9.7	Watchdog .....	45
8.9.8	Zone programming .....	45
8.9.9	Extra Devices Detected .....	47
8.9.10	Mismatch Detected .....	47
<b>9</b>	<b><i>Incoming Fire Alarm Signal .....</i></b>	<b>48</b>
<b>10</b>	<b><i>Accessing a Loop, Device or Zone .....</i></b>	<b>49</b>
<b>11</b>	<b><i>Modem / Programming / Debug Interfacing .....</i></b>	<b>50</b>
<b>12</b>	<b><i>Expanding the FACP with Compatible FireFinder PLUS Boards .....</i></b>	<b>51</b>
12.1	Ancillary Services .....	51
12.2	Compatible <i>FireFinder PLUS</i> Boards .....	51
12.3	Expansion Board .....	52
12.4	8 Zone Conventional Board .....	53
12.5	32 Zone Alarm Mimic Card .....	54
12.6	8 Way Switch and Indicator Card .....	55
12.7	16 Way Input Board .....	56
12.8	8 Way Relay Board .....	57
12.8.1	Internal Relay Board .....	57
12.8.2	Remote Relay Board .....	58
12.9	8 Way Sounder Board .....	59
12.10	4 Way Fire Fan Module .....	60
12.11	4 Way Fan Termination Board .....	61
12.12	Bargraph Display Card .....	62
12.12.1	Mechanical .....	62
12.12.2	Front Panel Decal .....	62
12.12.3	Front Panel Controls .....	62
12.13	Occupant Warning Systems .....	63
12.14	Communications Extender Board .....	64
12.15	<i>SmartTerminal</i> .....	65
12.15.1	Overview .....	65

12.15.2	Mechanical.....	66
12.15.3	Installation & Cabling.....	67
12.15.4	Setting the <i>SmartTerminal</i> Address .....	67
12.15.5	Operation.....	68
12.15.6	<i>SmartTerminal</i> Controls and Indicators.....	69
12.15.7	<i>SmartTerminal</i> Screen Format .....	69
12.16	Printer.....	71
12.16.1	Indicators and Buttons.....	71
12.16.2	Maintenance .....	72
12.16.3	Printer Connections and Jumpering .....	74
12.16.4	Printer 5 Volt Power Supply.....	74
12.17	Agent Release Control.....	75
12.17.1	Operation.....	75
12.17.2	Agent Release Module .....	78
12.17.3	Local Control Station .....	79
12.17.4	Agent Release Termination Board .....	82
12.17.5	Interface Wiring.....	83
<b>13</b>	<b><i>Expanding the System Through Networking .....</i></b>	<b>84</b>
13.1	Networking .....	84
13.2	Network Interface Card .....	84
13.3	High Level Interface Expander.....	86
<b>14</b>	<b><i>Certification Information.....</i></b>	<b>88</b>
<b>15</b>	<b><i>Maintenance and Troubleshooting Chart .....</i></b>	<b>89</b>
15.1	Maintenance.....	89
15.2	Troubleshooting <i>FireFinder PLUS</i> .....	90
<b>16</b>	<b><i>Compatible Devices .....</i></b>	<b>91</b>
<b>17</b>	<b><i>Address Setting.....</i></b>	<b>93</b>
<b>18</b>	<b><i>Glossary of Terms.....</i></b>	<b>94</b>
<b>19</b>	<b><i>Definitions .....</i></b>	<b>95</b>
<b>20</b>	<b><i>Specifications .....</i></b>	<b>96</b>
<b>21</b>	<b><i>QUICK REFERENCE GUIDE .....</i></b>	<b>98</b>

## 1 About This Manual

### 1.1 Introduction

This manual contains all the information required to install, commission and operate the **FireFinder PLUS** Fire Alarm Control Panel (FACP) and is only available to and for the use of personnel engaged in its installation, commissioning and operation.

### 1.2 General Requirements

The **FireFinder PLUS** FACP has been designed and manufactured from high quality commercial components so as to comply with major world standards. To ensure these standards are not compromised in any way installation staff and operators should;

- Be qualified and trained for the task they undertake;
- Be familiar with the contents of this manual prior to the installation, commissioning or operation of a **FireFinder PLUS** control system;
- Observe anti-static pre-cautions at all times; and
- Be aware that if a problem is encountered or there is any doubt with respect to the operational parameters of the installation the supplier should be contacted.





### 1.3 References

<b>ConfigManager:</b>	Operation Manual
<b>Apollo:</b>	Detector / Device Manuals
<b>Ampac:</b>	Product Data Sheets

#### **New Zealand Standard:**

NZS4512-2010: Fire Detection and Alarm Systems in Buildings

### 1.4 Symbols

	Important operational information
 <b>Note:</b>	Configuration considerations
	Observe antistatic precautions
	Mains supply earth
	DANGER mains supply present

## 2 Introduction

### 2.1 System Overview

The purpose of the **FireFinder PLUS** Fire Alarm Control Panel (FACP) is to monitor changes in inputs, report those changes and update selected outputs as programmed.

### 2.2 Overview & Key Features

The **FireFinder PLUS** is an Intelligent Analogue / Addressable and / or Conventional Fire Alarm Control Panel capable of supporting:

- Apollo Discovery and XP95 Intelligent Detectors, Multisensor, Photoelectric, Ionisation, Thermal (heat) and CO detectors..
- Addressable Initiating Devices: Modules that monitor any conventional normally open contact such as supervisory switches and flow switches.
- Conventional two wire zone detector circuits
- Multiple input/outputs
- High Level Interfaces
- **SmartGraphics**
- EV3000
- Nurse Call
- **SmartTerminal**
- Remote LED mimics
- Peer to Peer networking
- Master Slave (Main - Sub) networking
- Main panel plus Data Gathering Panels networking

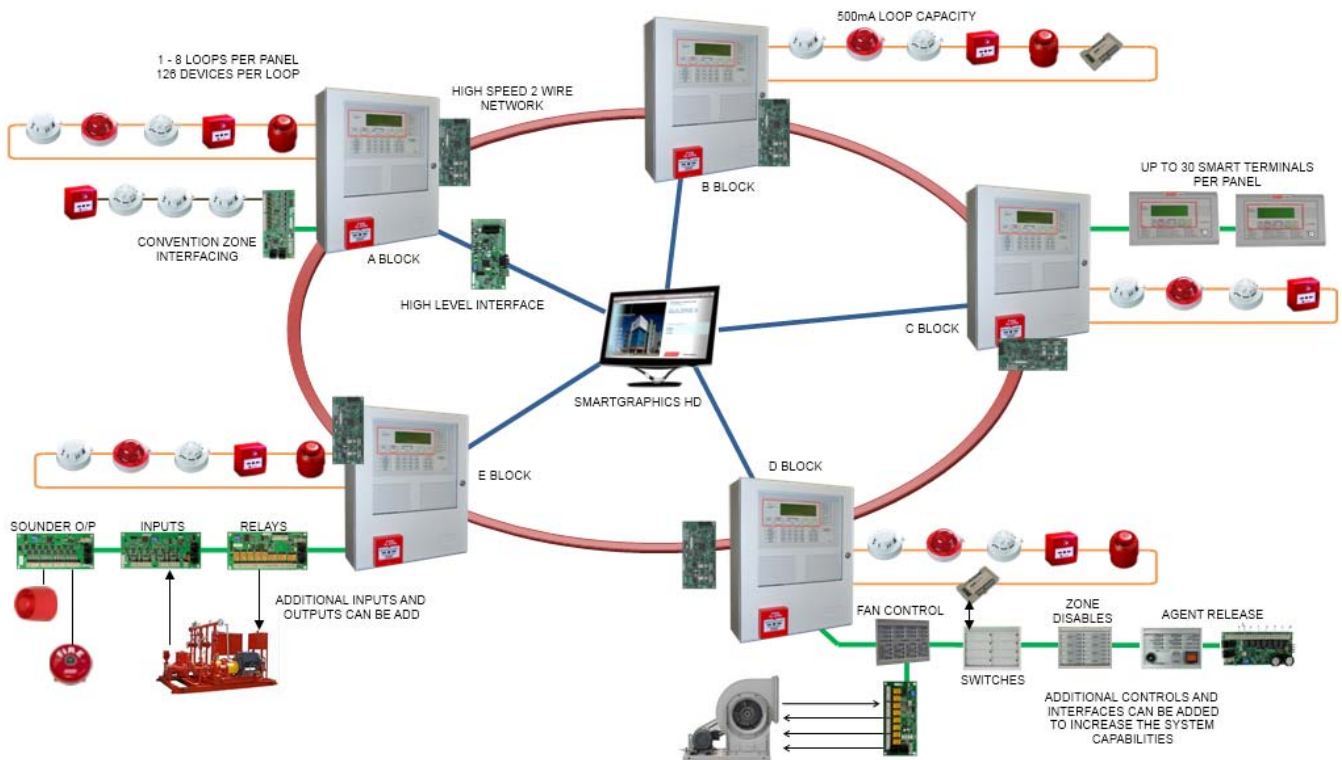

Figure 1: Typical Application



### 2.3 FACP Configuration Examples

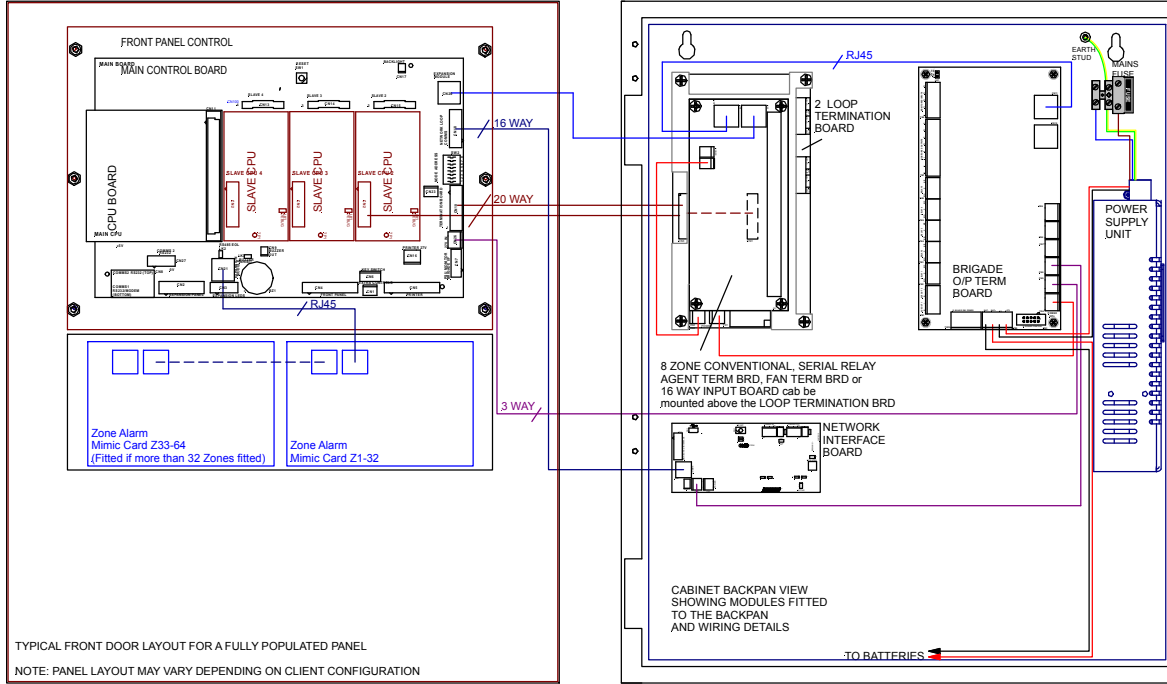

Figure 2: Typical Example of a SP1M/SP1X Layout

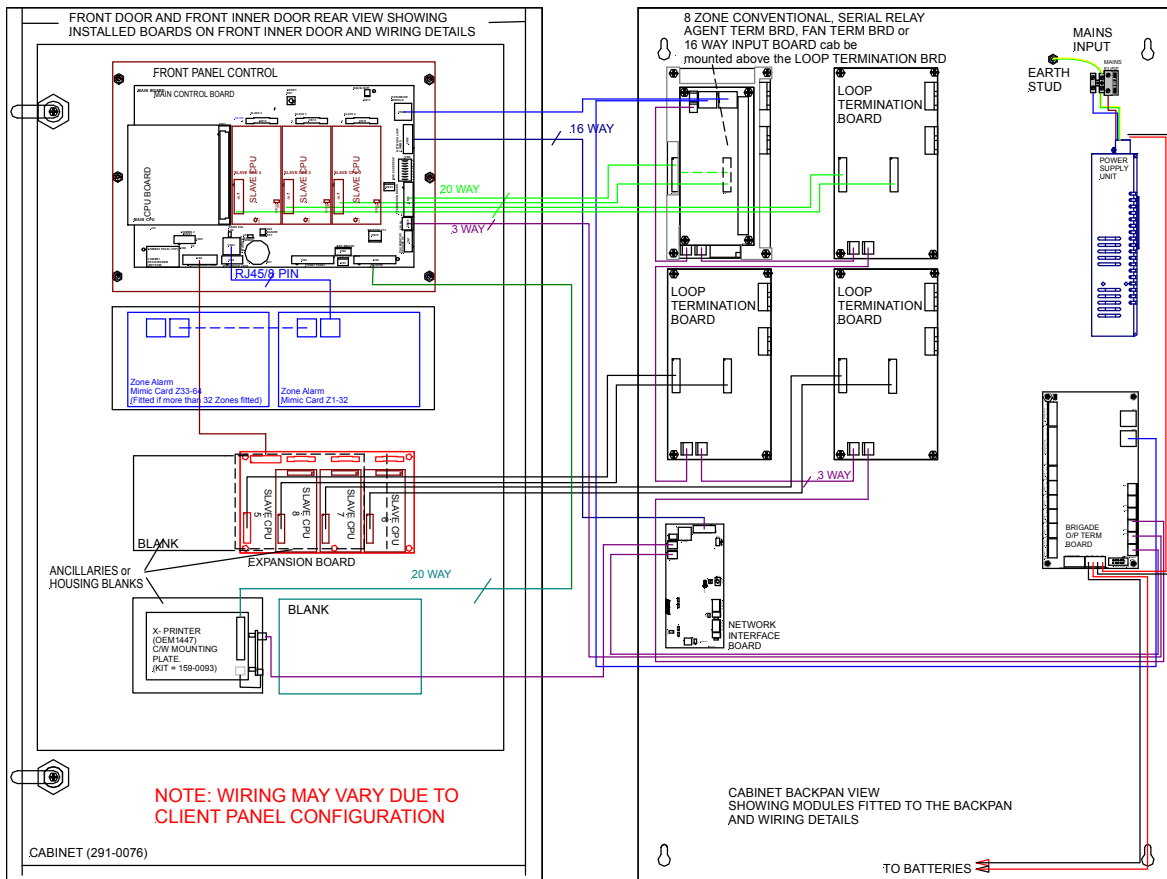

Figure 3: Typical Example of a SP8 Layout

### 3 FireFinder Plus Description

The following description does not relate to specific cabinets as the size of each cabinet will vary with the amount of hardware fitted.

The heart of the **FireFinder PLUS** consists of two boards collectively known as the **Controller**. These boards are the Main Board and the CPU board. Combining these two boards with a front panel forms the basis for a **FireFinder PLUS** FACP. A single **Controller** without an expansion board has the capacity to interface to four (4) Slave CPU's modules. These Slave CPU's can be used for Loop Termination Boards.

The Main Board has the Slave CPU Board for the first Loop Termination Board and the provision for mounting of up to three additional Slave CPU's to interface to loops 2 - 4. The Slave CPU's all have the same software installed and the manner in which they operate is automatically determined by the type of termination or interface board onto which they connect.

If the system is to be expanded to have more than four Slave CPU's an Expansion Board is required. This board contains Slave CPU No. 5 and expansion sockets for three more to interface to loops 6 - 8. This configuration allows for a maximum number of 8 Slave CPU's that any one **Controller** can accommodate.

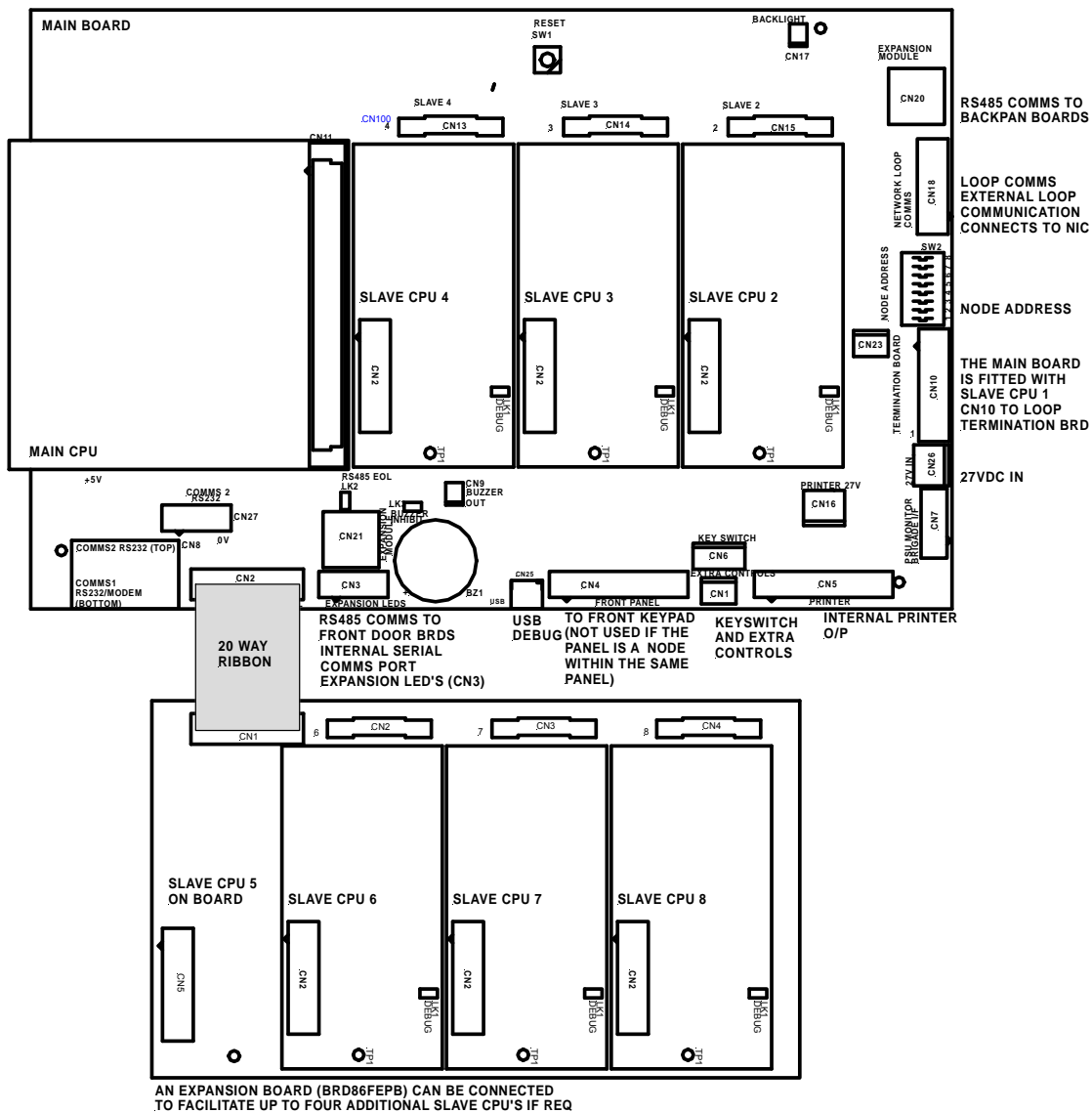

Figure 4: Single Controller Board with Expansion Board

**FireFinder PLUS** has an internal RS485 communication bus that allows for various ancillary boards (add on modules) to be connect to the panel. These boards can be used to control and monitor field plant equipment or the addition of an agent release module.

Where the system design exceeds the capability of one **FireFinder PLUS** then other **FireFinder PLUS** panels can be networked together to provide an expanded system containing multiple boards in a variety of applications.

Some of these applications include:

- A Master / Slave (Main Sub) FACP arrangement (MFACP / SFACP)
- A Peer to Peer System
- Use of Data Gathering Panels (DGP's)
- **SmartTerminal**
- **SmartGraphics**

A Network **FireFinder PLUS** System supports a combination or all these options on a single network. Each panel on the network is regarded as a "node". The NETWORK BUS is accessed using a Network Interface Card (BRD86NIC). The network configuration determines whether a NIC is required. Configurations can be;

**Master / Sub FACP:** Where there is one or more FACP's configured as local panels then each report the status of their associated zones/devices to a MFACP. There is no control between local panels as the MFACP is structured to have full control of the entire system.

**Peer to Peer:** Each FACP user can take control of the entire fire system from any FACP.

**Data Gathering Panel:** The use of this type of panel may be installed where there is a need to have field terminations only at one location and all control is performed by an FACP that is remotely located.

**SmartTerminal:** Provide the user with the ability to monitor the status of designated areas or an entire site as well as execute specific interrogation tasks.

**SmartGraphics:** Is an active graphics system connected to the **FireFinder PLUS**.

## 4 Placing The Basic System Into Operation

### 4.1 Unpacking

Carefully unpack the **FireFinder PLUS**.

The package should include:

- **FireFinder PLUS** Fire Alarm Control Panel
- An Operators manual
- 003 keys

### 4.2 Anti-Static Precautions

To prevent damage to components, modules and boards, anti-static precautions **MUST** be observed while performing any task within the FACP. The same applies to those situated in the field



### 4.3 Working On The System

**(i)** Prior to unplugging any connector, connecting or disconnecting any wiring, removing or replacing any module or board, ensure that both the Mains and Batteries have been isolated to prevent damage to panel components.

### 4.4 The Cabinet

**Features:**

- The cabinet is available in four different styles. Each style has the capability of being either surface or flush mounted. With flush mounting though a surround is required.
- Normally painted Surf Mist Ripple. Other colours are available on request.
- The inner and outer door hinges are mounted on the left-hand side of the cabinet which allow the doors open to an angle of 100°. A keyed entry is provided
- Knockouts are positioned on gland plates and a cut out is available on the rear of the cabinet to simplify cable entry. Mounting The Cabinet



**Note:** *It is recommended the cabinet should be installed in a clean, dry, vibration-free area.*

Open the front door. Use the keyhole mounting holes in the top corners and in the lower middle of the unit to mount it on the wall. Cables to connect the system to its external actuating devices are brought in through the knockouts on the top or bottom of the cabinet.

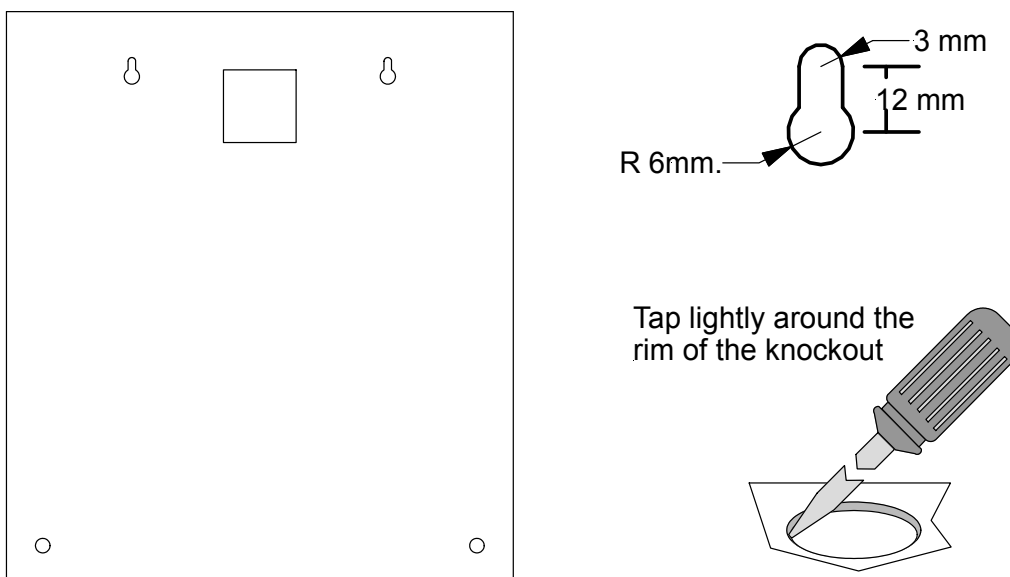

Figure 5: Example SP1 Back Pan Mounting Hole & Removing Knockouts

### 4.5 Cable Types and Limitations

All System wiring should be installed in accordance with the national wiring regulations where the panel is being installed.

To comply with EMC (Electro Magnetic Compatibility) regulations and to reduce the risk of electrical interference in the system wiring, we recommend the use of Fire-resistant screened cables throughout the installation, examples of which include the following:

Manufacturer	Cable Type	CoreSize (mm <sup>2</sup> )		
		1	1.5	2.5
Ventcroft*	No Burn Platinum	✓	✓	✓
Ventcroft	Diamond	✓	✓	✓
Prysmian cables & systems Ltd	FP200 Gold LSOH	✓	✓	✓
Prysmian cables & systems Ltd	FP Plus	✓	✓	✓
AEI Cables Ltd	Firetec Multicore LSZH	✓	✓	✓
CAvicel SpA	Firecel SR/114H	✓	✓	✓
Tratos Cavi SpA	FIRE-Safe TW950	✓	✓	✓
Eland Cables	FireForce	✓	✓	✓
Draka	Firetuf (OHLS)	✓	✓	✓
Draka	Firetuf Plus	✓	✓	✓

\*

### 4.6 Power Supplies and AC Mains Installation

Generally the AC Mains will be connected to either a 5 Amp 27 volt supply or 14 Amp 27 volt supply.

These supplies will be either mounted in the upper or lower right hand corner of the cabinet with the Brigade Board mounted above or below.

The wiring should enter the cabinet through the nearest knockout entry hole on that side.

Refer to Figures 6 - 9 for the wiring and fusing details.

#### 4.6.1 Connecting the Mains Earth

All earth cabling shall be terminated to the panel Chassis Earth Terminal in a star configuration.

The earth cable closest to the cabinet body shall have an M4 SPW beneath the lug then an M4 SPW and M4 nut.

Each additional earth cable shall be terminated with an M4 SPW and M4 nut.

An additional M4 nut and M4 SPW are fitted to the Chassis Earth Terminal for installers to connect their Mains Earth.

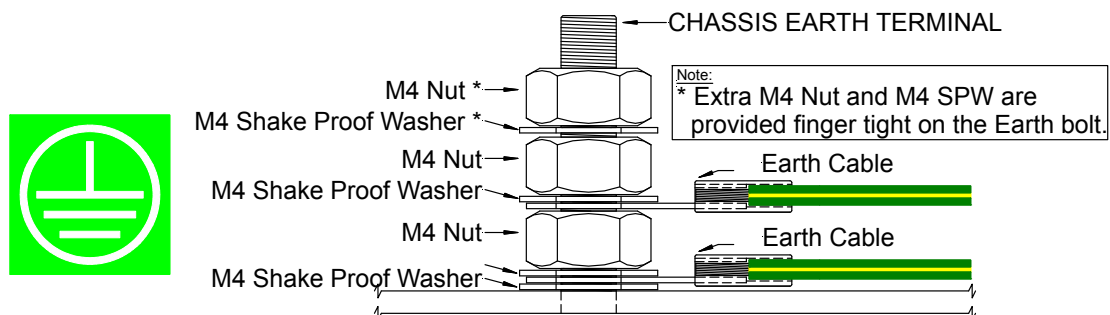

Figure 6: Panel Earthing

**4.6.2 Connecting Power Supply**

**Output Voltage:** 27.4 Volts.

**FUSE Rating 5A PSU:** 2 Amp 3AG Slow Blow

**FUSE Rating 14A PSU:** 5 Amp 3AG Slow Blow

Mains cable should be no less than 0.75mm<sup>2</sup>

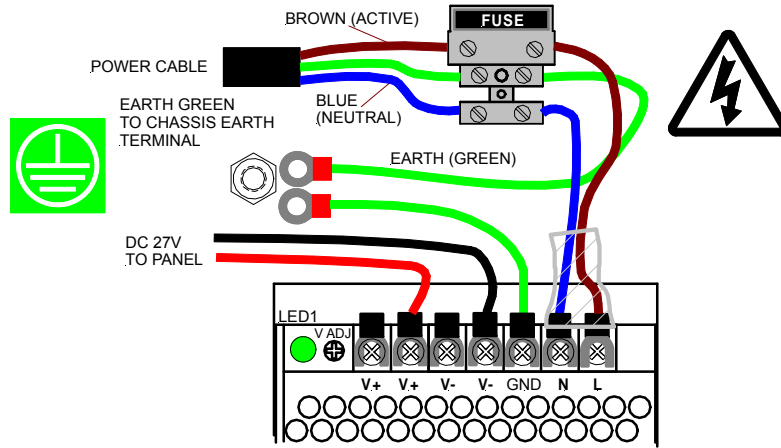

Figure 7: Mains Power Connection to the Power Supply

**4.7 CORRECT Power Up / Turn “ON” Procedure**

Once all the field devices are installed and the wiring has been correctly terminated the **FireFinder PLUS** is ready to turn on. For reliable power up it is essential the following procedure be followed:

1. Turn the Mains power on, **THEN**
2. Connect the batteries observing correct polarity.
3. The green power on LED should be illuminated.

### 4.8 Brigade / PSU Monitor Board

The Brigade / PSU Monitor Board (BRD86BPSC) monitors and controls the power supply, battery charging, monitored / un-monitored inputs, outputs and the 5 relay outputs.

#### Connections

TB(x)	Function	Type of Output
TB1	Aux Out x 2	Protected
TB2	Relay 1	1 Amp Voltage Free Contacts
TB3	Relay 2	1 Amp Voltage Free Contacts
TB4	Relay 3	1 Amp Voltage Free Contacts
TB5	Relay 4	1 Amp Voltage Free Contacts
TB6	Relay 5	1 Amp Voltage Free Contacts
TB7	Monitored Outputs x 4	24Vdc EOL
TB8	Monitored Inputs x 4	Switched Negative, EOL
TB9	Battery Out / 27VDC PSU IN	Protected
TB10	External Board / SW POWER	
CN(x)	Function	Type of Output
CN1	JTAG	
CN1	SGD	
CN3	External Board Controls	
CN4-8	Power Out	1 Amp ( protected )

#### Relay Information

Voltage Free contacts are rated at 1A @ 30V

#### Back EMF Protection

**i** Inductive loads fitted to the Brigade PSU Monitor Board **MUST** be fitted with “Flyback” diodes at the load for back EMF protection.

#### Transient Protection

**i** Recognised transient line protection methodologies at the FACP and the load **MUST** be considered when connecting any control devices to the outputs be they in close or remote.

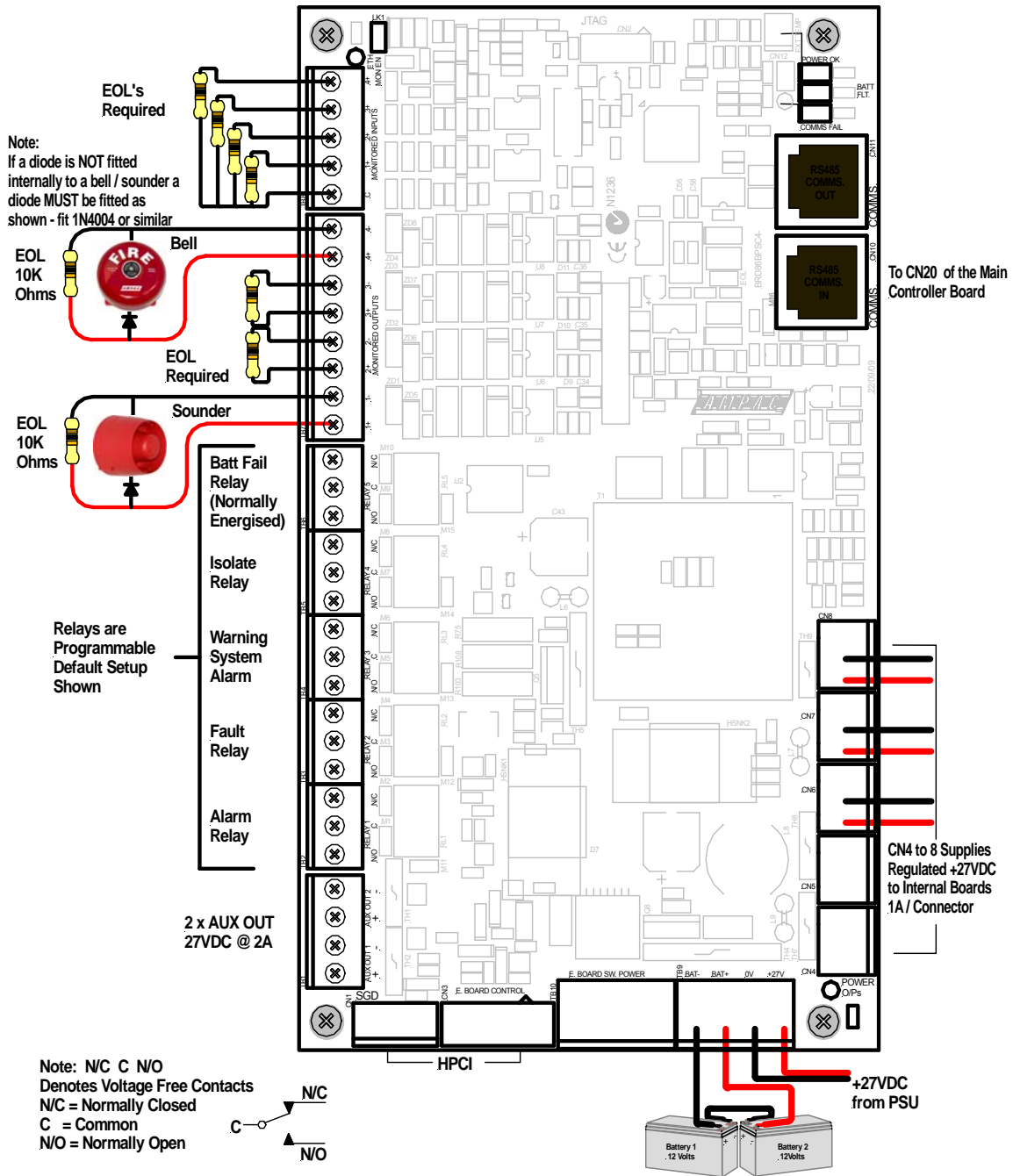

Figure 8: Brigade / PSU Monitor Board Layout

**Note:** When connecting to the Brigade PSU Monitor board transient and “Flyback” (Back EMF) protection methodologies MUST be applied.



### 4.8.1 Battery Connections

A **FireFinder PLUS** requires two (2) 12 volt batteries (TB9). The batteries should be placed into the bottom right hand side of the cabinet.

A red and black lead coming from TB1 on the Brigade Board will be clearly seen in the same area, this lead is to be connected to the batteries red to positive and black to negative once the system is operating on Mains supply.

Battery size is dependant on system configuration and can vary from 12 AHr to over 100 AHr.

**Note:** Refer to Ampac's battery calculation tool to calculate the required battery size.

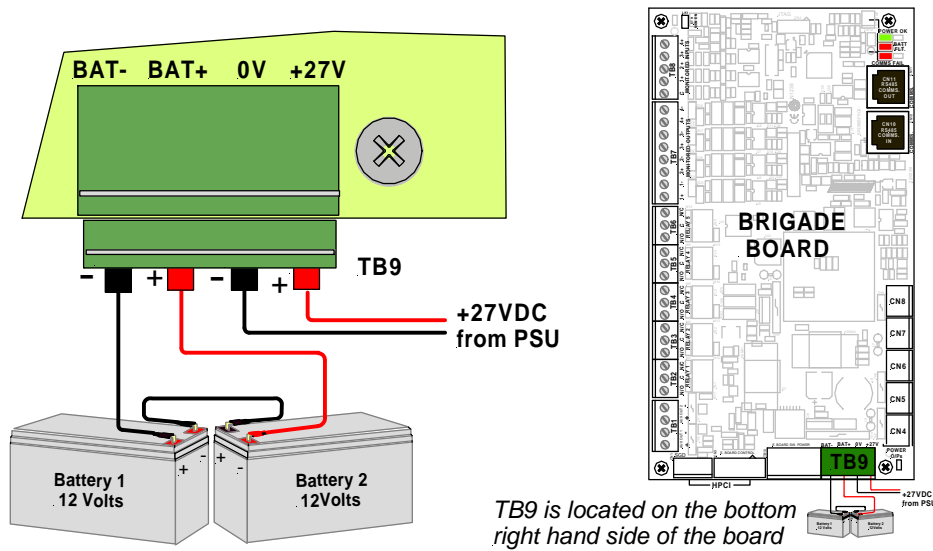

Figure 9: Battery Connections to the Brigade / PSU Monitor Board

### 4.8.2 Auxiliary 27 Volt Power

Two (2) 1 Amp outputs are available from TB1 terminals 1+ (plus) and 2- (minus) or 3+ and 4- on the Brigade Board. It is important to note these outputs are short circuit monitored.

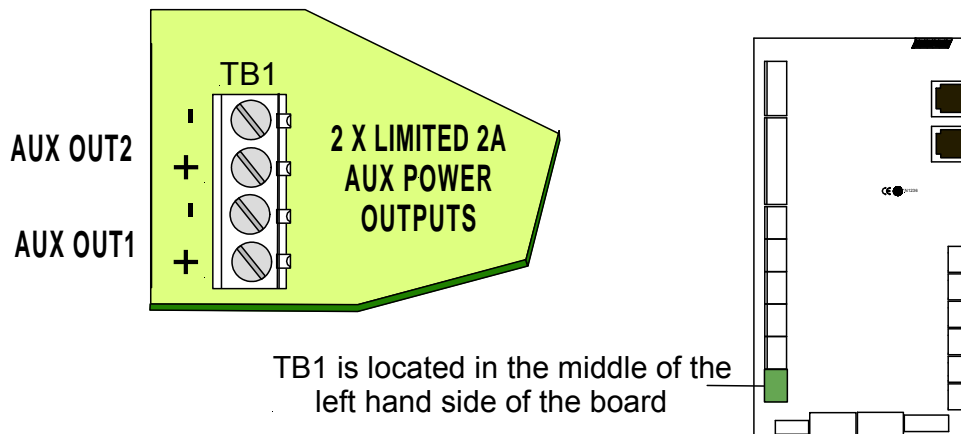

Figure 10: Auxiliary 27VDC Power Output

### 4.8.3 Monitored Inputs

Four independently monitored inputs (TB8) are provided and can be configured for a variety of uses.

- **Manual Call Point** – if activated the FACP will go into alarm
- **DBA** – if activated all Outputs configured as Sounders or EWIS and Relays configured as EWIS (NZ Only)
- **Class Change** – if activated all Sounders and Sounder Outputs in Sounder Group 1
- **External Fault** – if activated the FACP will indicate a Fault condition
- **Ancillary Disable / Door Switch** - if activated, the FACP’s “DISABLED” and ANC OUTPUT STATUS LEDs will both be turned on. Note that this event is used to indicate an ancillary/auxiliary disablement or a door-opened condition if a door switch is fitted. It also activates any Relays on the Brigade board configured as “Isolate” relays and affects the Brigade Board’s “Aux/Anc” outputs based on their “normally energised” settings.
- **Evacuate** – if activated the FACP goes into Evacuation.
- **Sounder Silence** – if activated all activated sounders are silenced.
- **Reset** – if activated a Master Reset is initiated.
- **Fire/Feedback** - if activated, the FACP’s “Fire Output On” LED will flash. Note that this is a latched condition and will only be cleared a “Master Reset” command from the FACP.
- **General Purpose** – for use in Functions (Cause and Effects)

The default configuration types for the inputs are as follows:

- Input 1 – DBA
- Input 2 – Ancillary Disable / Door Switch
- Input 3 – Reset
- Input 4 – Sounder Silence

The inputs have been designed to operate with a programmable EOL of 3K3Ω, 10KΩ 22KΩ or Unmonitored (no EOL) the 10K EOL is the default. The normal and active ranges change according to the end of line selected.

Line resistance (10K EOL)	Sensed Condition
0Ω– 150Ω	Short circuit Fault
500Ω – 4KΩ	Active condition
8KΩ – 15KΩ	Normal
20KΩ to ∞	Open circuit Fault

**Note:** Door Switch is Open for Normal Operation and not Monitored

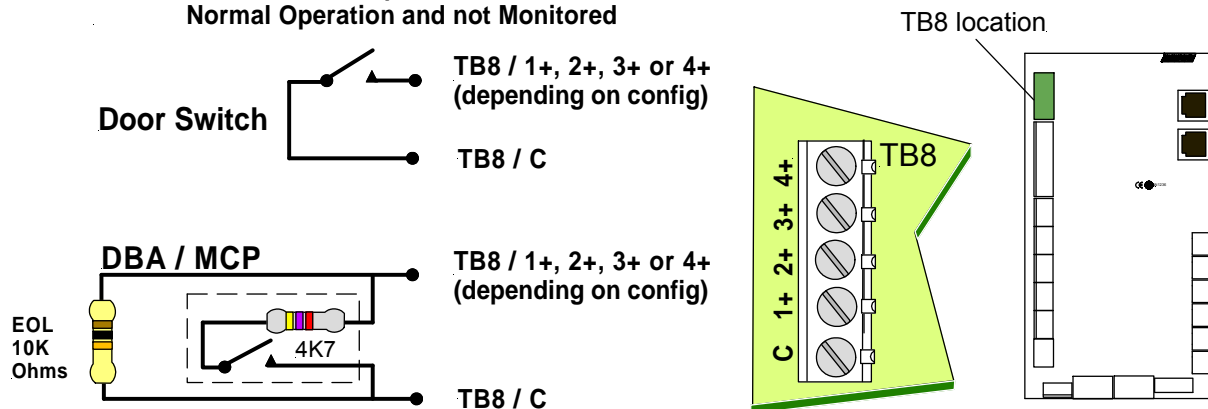

Figure 11: Inputs DBA / MCP and Door Switch Wiring

### 4.8.4 Monitored Outputs

Four independently monitored and controlled outputs (TB7) are provided and can be configured for a variety of uses.

- **Alarm Device** - activated when any of its four sounder groups is active. The output is turned off during an Alarm (sounder) disable or Alarm (sounder) silence condition.
- **Fire / FARE** – activated by alarm condition (EN54-2 Clause 7.7 and 7.9.1). The output is turned off during a FARE disable condition.
- **Ancillary** - activated on device alarm conditions. The AUX/ANC Output is turned off during an Auxiliary disable condition.
- **Warning System** - activated on evacuation and device alarm conditions. The output is turned off during an Alarm (sounder) disable or Alarm (sounder) silence condition.
- **Fault** - activated on all fault conditions (EN54-2 Clause 8.9). The output is turned off during a FWRE disable condition.
- **General Purpose** – activated via the Configmanager “Function” programmed logic.

These monitored switched outputs, supply a nominal 24VDC, at up to 1 Amperes. Monitoring is for short, open and earth faults when the output is OFF.

The outputs have been designed to operate with a programmable EOL of 3K3Ω, 10KΩ 22KΩ or Unmonitored (no EOL) the 10K EOL is the default.

Line Impedance (10K EOL)	Reported Condition
0Ω– 50Ω	Short circuit Fault
50Ω – 150Ω	Indeterminate: Maybe reported as shorted or normal
150Ω – 15KΩ	Normal
15KΩ – 40KΩ	Indeterminate: Maybe reported as normal or open circuit
40KΩ to ∞	Open circuit Fault

Warning systems such as the Ampac OWS Amplifiers and sounders are connected to the Brigade / PSU Monitor Board as shown below. If more sounders are required, the Sounder / Bell Control Board must be used.

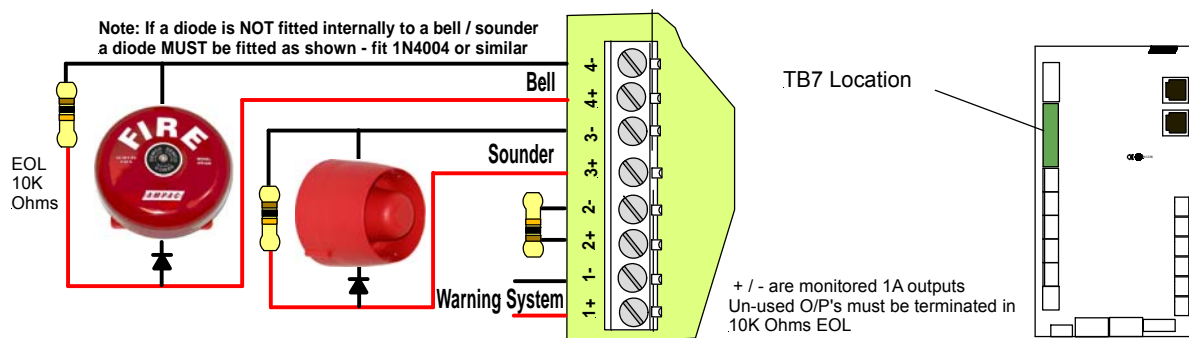

Figure 12 Connecting a Bell / Sounders



### 4.9 High Current Interface Board

When the 14Amp power supply is used in the FACP the High Current Interface Board is required to provide protection for the boards, cards and other 27VDC distribution within the FACP.

The board plugs/connects into the Brigade / PSU Monitor Board (BRD86BPSC) and the 27V DC output from the PSU is connected to TB1 of the BRD86HCI instead of TB9 on the BRD86BPSC

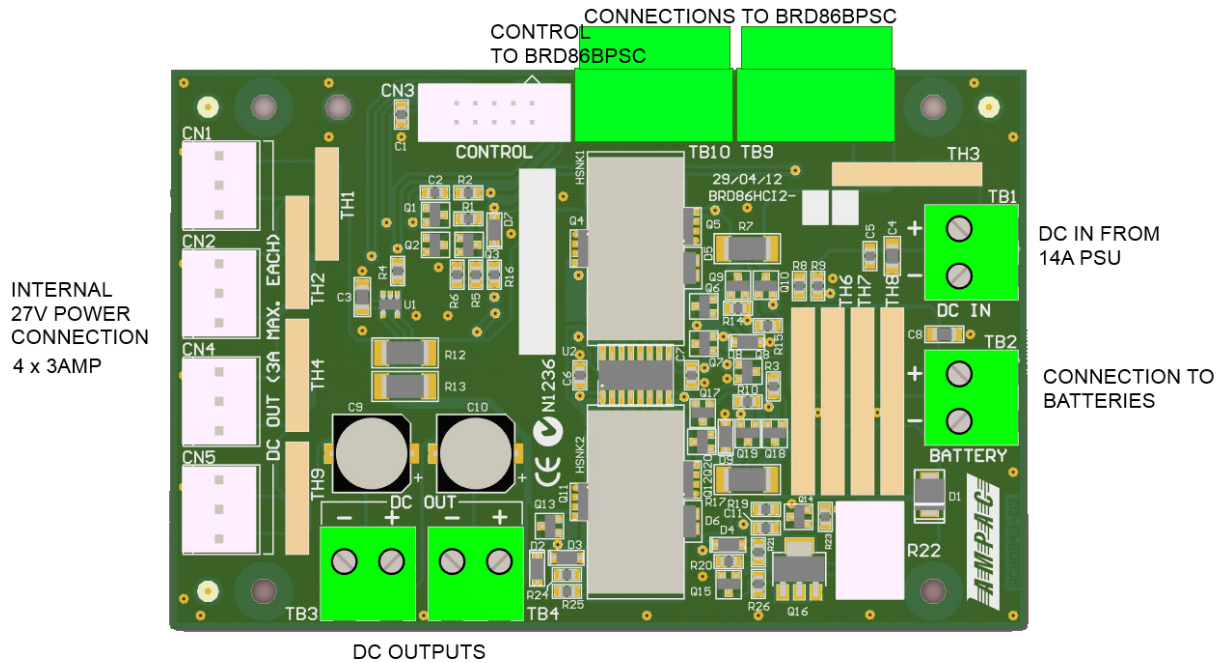

Figure 14: High Current Interface Board

**Connections**

TB	Function
1	27VDC PSU IN
2	Battery Out
3	27VDC Out
4	27VDC Out
9	Battery Out / 27VDC PSU IN
10	External Board / SW POWER
CN	Function
1 - 5	27VDC 3A Max

### 4.10 Main Board

The Main Board (BRD86MBA) carries the devices for interconnecting to all the other Boards, a buzzer for auditory indication, the backlight power supply for the LCD and CPU Reset.

The Main CPU is mounted on this board and connected to it by CN11. The main connection board then provides interfacing to

- Up to 3 Slave CPU's (Slave CPU 1 is onboard)
- A printer
- A Modem
- An Expansion Panel
- An Internal serial bus
- An External communication bus.

#### Connections

CN1	Extra Control (Not Fitted)	CN15	Slave CPU connection
CN2	Expansion Panel	CN16	Printer 27VDC Out
CN3	Expansion LED's (Not Fitted)	CN17	To LCD Backlight supply
CN4	Front Keypad	CN18	External Loop Communication
CN5	Printer	CN19	LCD Characters
CN6	Key Switch (Not Fitted)	CN20	RS485 Communications Port 1
CN7	Brigade Output	CN21	RS485 Communications Port 2
CN8	Modem and RS232 Comms	CN22	To LCD Backlight supply
CN9	External Buzzer Output	CN23	Slave CPU Debug (Not Fitted)
CN10	Slave CPU output 1	CN24	Jtag Programming Slave CPU1 (Not Fitted)
CN11	Main CPU	CN25	USB Programming
CN12	LCD Graphic	CN26	27VDC In
CN13	Slave CPU connection	CN27	Comms 2 RS232
CN14	Slave CPU connection	CN28	27VDC In (not fitted)

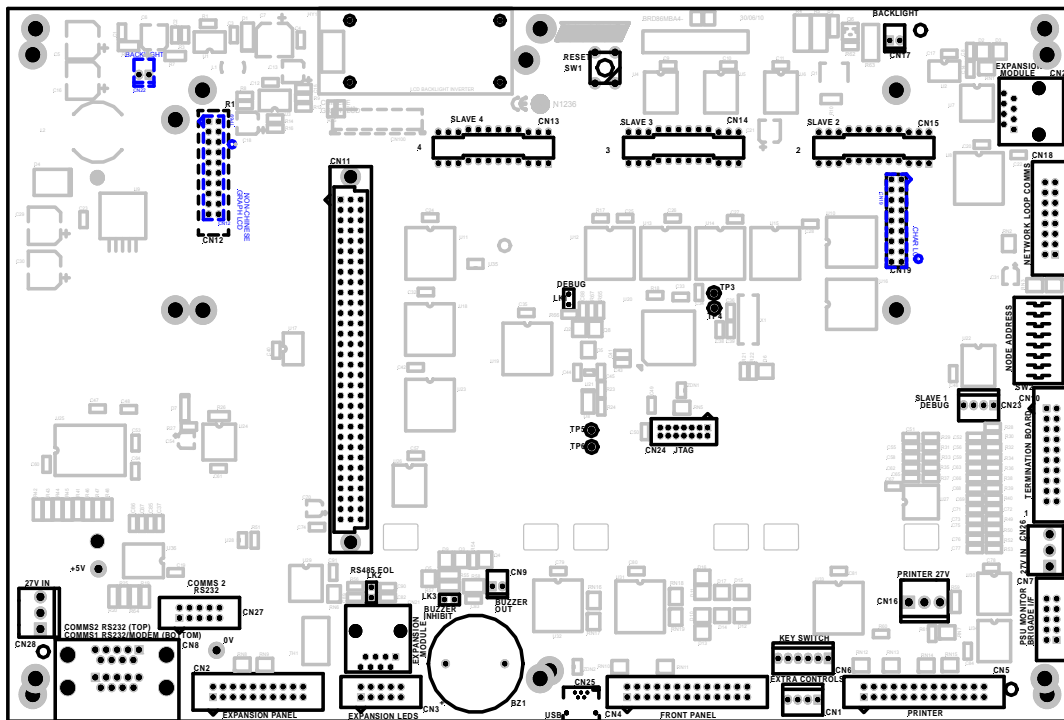

Figure 15: Main Board Layout with no Main CPU or Slave CPU's

### 4.11 Front Panel Board

The Front Panel Board (BRD86FPB) provides the buttons used to control the FACP as well as all LED indications. All LED's are surface mounted and the buttons are embedded within the board. The LCD is viewed / protected by a clear Perspex screen.

#### Connections

CN2	To CN4 Main Board
-----	-------------------

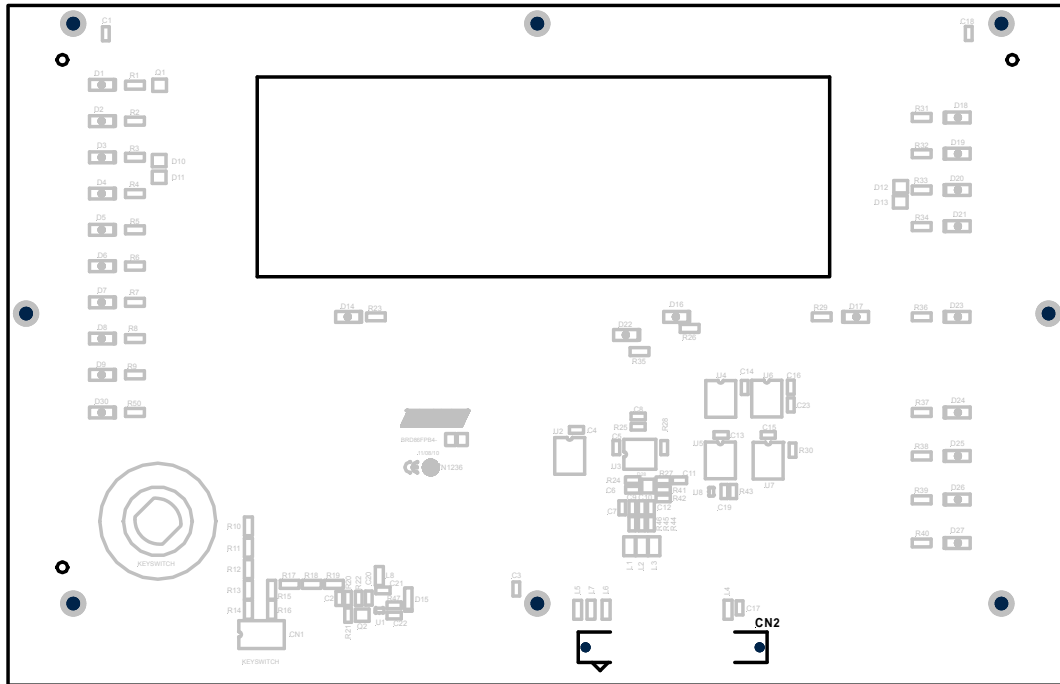

Figure 16: Front Panel Board

### 4.12 Main CPU

The Main CPU (BRD86MCP) holds the main central processing unit including the Application software and Configuration settings for the FACP.

- The Main CPU is a 4-layer surface mount board
- The processor runs at 60MHz.
- 16Mbytes of FLASH
- 32/64 Mbytes SDRAM

#### Connections

CN1	USB (Not Fitted)
CN2	To Main Board CN11

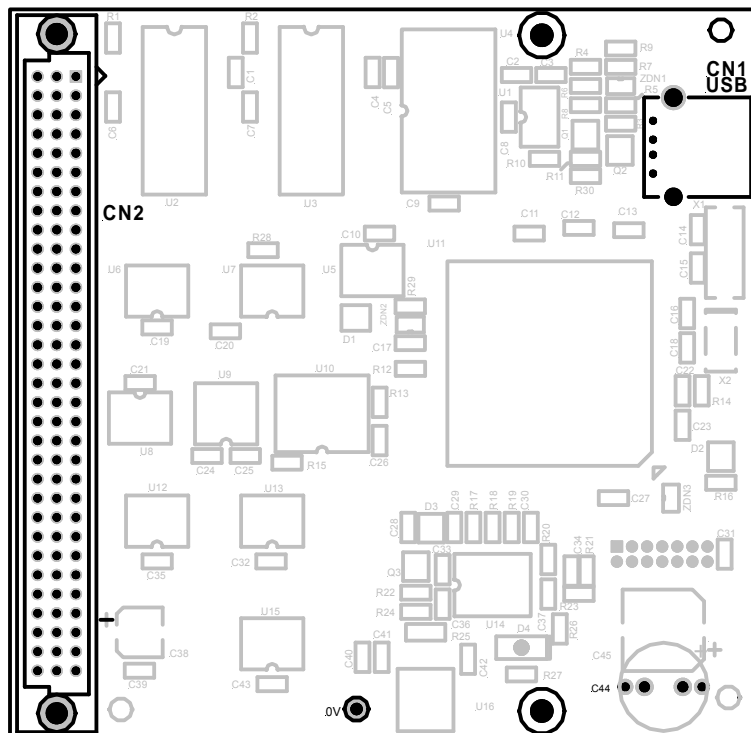

Figure 17: The Main CPU Board PCB Layout



### 4.13 Slave CPU

The Slave CPU (BRD86SCPU) provides the interfacing signals and I/O's required to allow the FACP to connect / communicate to a variety of termination boards.

A single chip micro controller U7 controls all operations of the FACP Slave CPU. This device contains the control program within Read Only Memory (ROM).

#### Automatic Termination Board Sensing

A unique feature of the Slave CPU is its ability to automatically sense the type of board it is connected to without the user having to configure the board to suit.

#### Connections

CN2	To Loop Termination Board
CN3	To Main Control Board

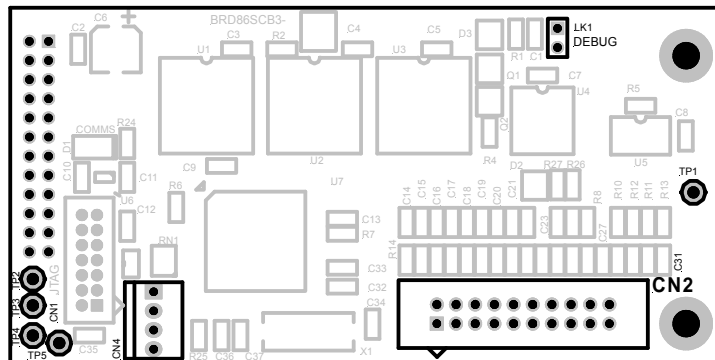

Figure 18: Slave CPU Board

### 4.14 Addressable Dual Loop Termination Board

The Addressable Dual Loop Termination Board (BRD86DLTB) acts as the interface between the external addressable devices and the control and monitoring functions of the **FireFinder PLUS**. Each board provides terminations for two loops and can be used with the Apollo range of detectors. One slave CPU is required per loop.

**Note:** Apollo devices L2 is +ve (positive), L1 is -ve (negative)

AMPAC strongly recommend that the **LoopManager** test set is used to check that the Apollo loop has been correctly installed and commissioned before connecting it to the **FireFinder PLUS**.

#### Loop Parameters

- 126 Apollo Devices (i.e. maximum address range)
- 500mA Current Max
- S/C protection circuitry activates at approximately 650mA
- Maximum length 1.2km

#### CONNECTIONS

CN1 / 2	To Slave CPU Board
CN3 / 4	27VDC in / out
TB1 / 2	To Addressable loop devices

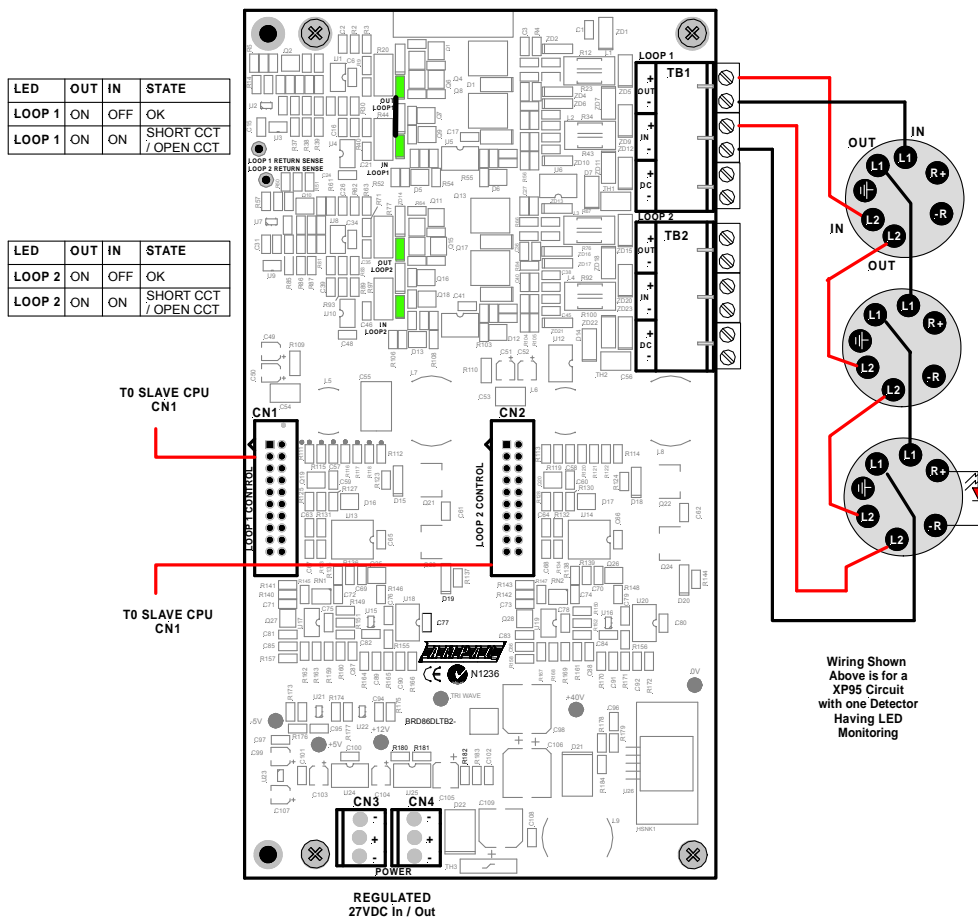



Figure 19: Addressable Loop Termination Board

**4.14.1 Detector loop Isolator Installation**

In applications where it is not necessary to use an isolating base for each detector, up to 20 detectors may be installed between isolating bases.

 **Note:** Refer to Apollo Isolating specifications and guidelines for further details.

If a short circuit or abnormally low impedance occurs, the base isolates the negative supply in the direction of the fault. When the short circuit is removed the power will automatically be restored.

 **Note:** Isolating base is polarity sensitive.

**4.14.2 Loop Isolator calculator**

The number of isolating devices on the loop can limit the maximum loop cable length depending on the type of cable used and the total loop current. Refer to the tables below for reference.

**Maximum Cable Length Using 1.5mm<sup>2</sup>. Cable**

Number of Isolators	0	5	10	15	20	25	30	35	40	45	50
Loop Current Total (mA)	<b>MAX CABLE LENGTH USING 1.5mm<sup>2</sup>.</b>										
50	1000	1000	1000	1000	1000	1000	1000	1000	1000	1000	1000
100	1000	1000	1000	1000	1000	1000	1000	1000	1000	1000	1000
150	1000	1000	1000	1000	1000	1000	1000	1000	1000	1000	1000
200	1000	1000	1000	1000	1000	1000	1000	1000	1000	1000	960
250	1000	1000	1000	1000	973	933	893	853	813	773	733
300	971	931	891	851	811	771	731	691	651	611	571
350	850	810	770	730	690	650	610	570	530	490	450
400	756	716	676	636	596	556	516	476	436	396	356
450	680	640	600	560	520	480	440	400	360	320	280
500	618	578	538	498	458	418	378	338	298	258	218

**Maximum Cable Length Using 2.5mm<sup>2</sup>. Cable**

Number of Isolators	0	5	10	15	20	25	30	35	40	45	50
Loop Current Total (mA)	<b>MAX CABLE LENGTH USING 2.5mm<sup>2</sup>.</b>										
50	1000	1000	1000	1000	1000	1000	1000	1000	1000	1000	1000
100	1000	1000	1000	1000	1000	1000	1000	1000	1000	1000	1000
150	1000	1000	1000	1000	1000	1000	1000	1000	1000	1000	1000
200	1000	1000	1000	1000	1000	1000	1000	1000	1000	1000	1000
250	1000	1000	1000	1000	1000	1000	1000	1000	1000	1000	1000
300	1000	1000	1000	1000	1000	1000	1000	1000	1000	1000	952
350	1000	1000	1000	1000	1000	1000	1000	950	883	817	750
400	1000	1000	1000	1000	993	926	859	793	726	659	593
450	1000	1000	1000	933	867	800	733	667	600	53	467
500	1000	964	897	930	764	697	630	564	497	430	364

**4.14.3 Loop Open / Short Circuit.**

In the case of an Open Circuit or Short circuit (short circuit isolators used) on the Loop Line the Loop board provides the ability to drive out from both sides of the loop (In and Out). When these Faults are repaired / cleared the panel will still report a Loop Fault until a Loop Test is performed on the appropriate loop. See section 8.5

## 5 FireFinder PLUS Control Panel

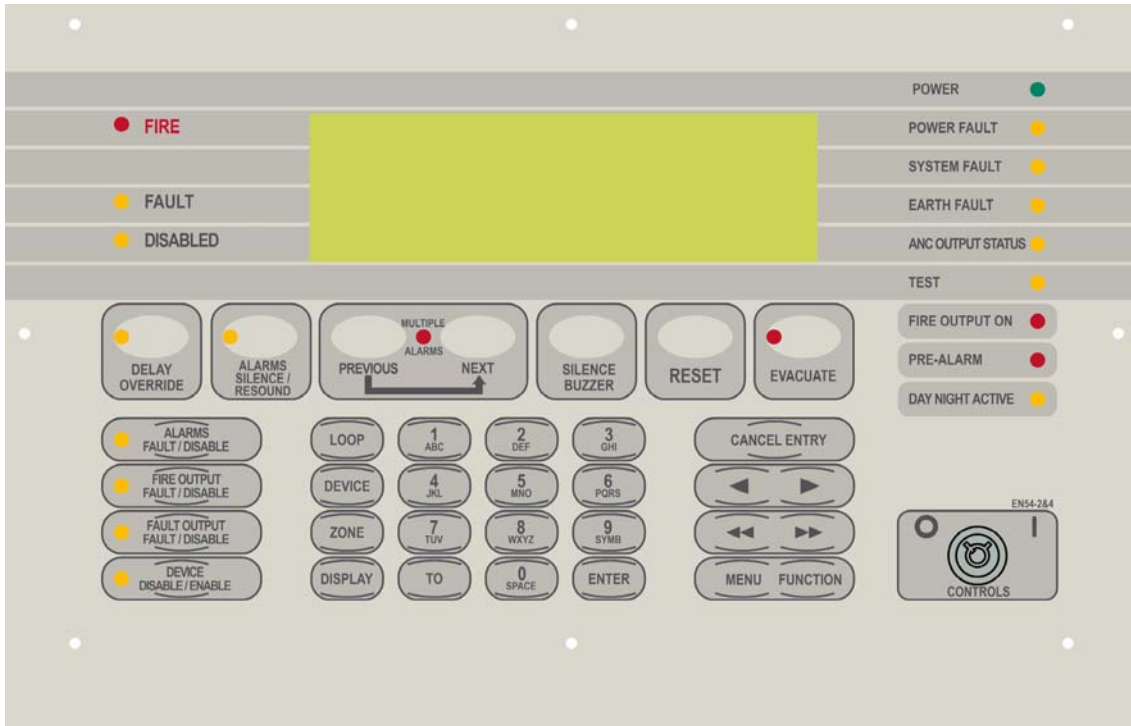
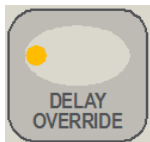

Figure 20: The **FireFinder PLUS** Control Panel with an 8 Line LCD

The LCD is used to display abnormal conditions and for interrogation, control and programming activities. When the FACP is in its normal state a default screen is displayed.

In access level 2 or higher the backlight shall always be ON. Alarm, Fault and Disable information is accessed through the Main Menu.

### 5.1 System Controls



Pressing this button (EN54-2 clause 7.11), when the Delay Mode is ON and one or more zones configured with investigation delays have their delay timer running, activating the DELAY OVERRIDE control overrides the investigation delay timer allowing the zone or zones to enter the fire condition immediately.

Indicator is illuminated steady when one or more zones are configured with Investigation delays and Delay Mode is active. The indicator will flash if any Investigation delay timer is running.

If the DELAY OVERRIDE control or EVACUATE control is activated while the investigation delay timer is running, then the indicator will go steady and the investigation zone enters the fire condition.

The LED indicator will only be OFF if:

- The Delay Mode is OFF
- No investigation delays are configured
- The panel has switched to day or night mode where no delays have been configured.



Pressing this button will silence any Bells or Sounders (activated either by a fire alarm, a manual evacuation or a manual alert) that are connected to the fire panel. If the bells or sounders are silenced the LED just beside the button will be illuminated steady indicating that the sounders have been silenced and a sounder resound is available. If a manual evacuate or manual alert condition is present when the Sounder Silence button is pressed, these conditions will remain visible

indicating the conditions are still present for resounding. A new Fire Alarm, manual evacuate or manual alert will resound all the previously silenced Bells and Sounders. Pressing ALARMS SILENCE/RESOUND a second time while the Sounder Silence LED is illuminated, will also re-sound the Bells and Sounders.

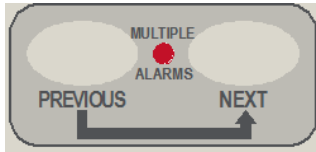

This button is used for scrolling backwards and forwards through fire alarms, faults, or disablement's displayed on the LCD. The Multiple Alarm LED will illuminate if there is more than one alarm present



Pressing this button will silence the panel buzzer, which sounds whenever there is a fire alarm or fault. The sound for a fire alarm is a steady sound where as for a fault it is intermittent.



Pressing this button will reset the panel, clearing any fire alarms and taking the LCD display back to its default screen, unless there are any un-cleared faults or disabled devices, these will continue to be displayed. Pressing reset will also clear the manual evacuate, the manual alert condition and the sounder silence condition. Note: Pressing reset will not clear any disablements including Sounder Disable.

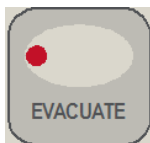

Pressing this button will activate the Sounders and Bells that have been programmed for manual evacuation and the LED just above the button will be illuminated steady. If the sounders have been previously silenced the LED above the ALARMS SILENCE/RESOUND button will turn off and the Sounders and Bells that were previously silenced will resound. This manual evacuate condition can only be cleared by a Reset and will override a manual "Alert" condition.



The LED is illuminated steady if any of the alarm devices (sounders and/or strobes) have been disabled and flashes if any of the alarm devices (sounders and/or strobes) are in fault. Disable has priority over fault

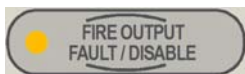

Pressing this button or if the FACP is fitted with a door switch and the door is opened the auxiliary output relay on the brigade board will be isolated. If the auxiliary fault / isolate is isolated the associated LED will light steady. Pressing the button again will de-isolate the auxiliary fault / isolate relay.



Pressing this button will disable the FWRE output relay on the Output board. If disabled the associated LED will also be illuminated. Pressing the button again will re-enable the FWRE relay. The LED will also be illuminated if the FWRE is in fault.



This button is used to disable or re-enable selected individual or groups of detectors, devices or zones.



Press this button followed by a number to select the loop you wish to access.

e.g. LOOP 4.



After selecting the Loop number press this button to enter the device number for the device to be interrogated.



Press this button followed by a number e.g. ZONE 4 to select the required zone.



Press this button after selecting the Zone number or the Loop and Device numbers to display the state of the device.



Press and hold this “display” button while using the  buttons to adjust the LCD contrast (Access level 2 required)



These buttons are used to navigate around the panel’s menus and enter data. If entering a descriptor, or some other data that contains characters as well as numbers, pressing the buttons multiple times will scroll through the available letters written on the button, in sequence. E.g. 1, A, B, C



Use this button to access a range of devices. E.g., 2 TO 7.



Press the ENTER button when using the panel, to enter data.



The CANCEL ENTRY button is used to delete data in a current field or return to the previously displayed menu.



Used to move the cursor back and forth when entering data in a field.



These buttons are used to move between fields when entering data and for adjusting the LCD contrast when the “Display” button is held on.















Pressing the MENU button will display the main menu on the LCD. Similarly pressing the FUNCTION button will display the function menu on the LCD.



NORMAL – Normal day to day operation. ENABLED – Access level 2.

*Note the key can only be removed in the NORMAL position.*

## 5.2 System Indicators

- FIRE**  This LED will be illuminated steady if any fire alarms are present on the system.
- FAULT**  This LED will be illuminated steady if there are any faults on the system, whether they are loop faults, module faults, device faults etc.
- DISABLED**  The LED will light steady if any detectors, devices or zones in the system have been disabled or if an output relay has been de-activated. The display will show the conditions as per EN54 9.2 and 9.4.2
- POWER**  This LED will be illuminated when power is connected to the FACP and switched on.
- POWER FAULT**  This LED will be illuminated when there is a supply fault. The following conditions constitute a fault.
- Mains power is not available.
  - The output voltage is too low.
  - The output voltage is too high.
  - The battery is not connected properly or has failed.
- SYSTEM FAULT**  This LED will be illuminated if the main system CPU is in fault
- EARTH FAULT**  This LED will be illuminated if there is an earth fault (+ or -) on any of the signal cables of the system.
- ANC OUTPUT STATUS**  The LED will be illuminated steady when the output is disabled and flashes when in fault
- TEST**  This LED will be illuminated when the panel is in any of the test modes.
- FIRE OUTPUT ON**  This LED is illuminated steady when there is an output configured as a Fire Output is turned on. Flashes when Fire Input On
- PRE-ALARM**  This LED will be illuminated when a device/detector is in the pre-alarm state.
- DAY NIGHT ACTIVE**  The LED is illuminated when the Day / Night facility has been enabled

## 6 Functions And Menus

**IMPORTANT NOTE:** *It is strongly recommended that all field programming changes be properly recorded.*

### 6.1 The Default LCD Display

In its normal state the **FireFinder PLUS** will display a screen similar to that shown below.

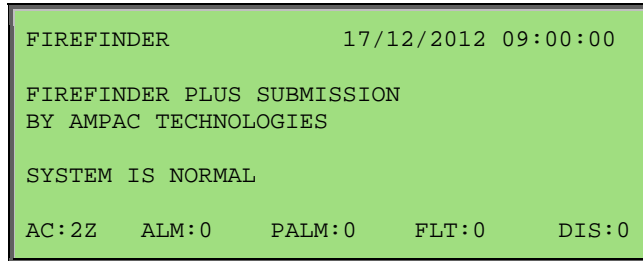

Figure 21: The Default LCD Display

This screen can be configured with the servicing company's name and phone number via a laptop or modem. The current date, time is set in the Function menu while system status is automatically displayed.

**AC:** is the current Access Level (ie 2Z is access level 2 Zone mode & 2D would be access level 2 device mode)

**ALM:** is the Alarm counter

**PALM:** is the Pre-Alarm counter

**FLT:** is the Fault counter

**DIS:** is the Disable counter

### 6.2 LCD Contrast

The Contrast can be adjusted using a combination of the button the and buttons.

Keep the 'Display' button pressed while simultaneously pressing the '<' button to take the contrast down 1 level, the '>' to take up the contrast by 1 level, the '<<' to take the contrast down by 8 levels or the '>>' to take the contrast up by 8 levels.

**Note:** *This button combination will only work in access level 2 or higher.*

### 6.3 Accessing Functions and Menus

At Levels 2 and 3, access to the panel Functions are password protected.

A new panel has a pre-programmed password of **2222** for Level 2 and **3333** for Level 3.

**Note:** *Only Authorised Service Technicians / Engineers have the ability to change passwords.*

**Note:** *All menus are provided with screen prompts and a "Quick Reference Guide" (see Section xx) guides the operator through the operation of the FACP.*



From the **DEFAULT DISPLAY**, press **MENU** or **FUNCTION**. The **FUNCTION** menu is password protected (actually a pass-number as it can only contain numbers) to prevent unauthorised changes to the panel's configuration.



## 6.4 Function Menu and Access Levels

Three levels of ACCESS are available via separate passwords so that access to certain facilities can be restricted (such as the ability to enter new passwords).

- Level I: Allows access to indications and controls to investigate and respond to a fire or fault warning.
- Level II: In addition to the level I facilities, quiescent, fire alarm fault warning, disable and test conditions.
- Level III: In addition to the level II facilities, reconfigure specific data or control and maintain the panel in accordance with the manufacturers' specifications.
- Level IV: In an addition to level III trained and authorised by the manufacturer to repair or alter the firmware of a panel.

### 6.4.1 Forgotten Passwords

Follow the following process if a password has been forgotten or misplaced;

Entering 9999 into the password field;

1. Take note of the 4 digit password number displayed on the screen; then
2. Contact the AMPAC head office and quote the above number;
3. A temporary password will be issued and a new password can then be programmed into the FACP.

 **Note:** *The temporary password becomes invalid if 9999 is entered again or if the panel is re-powered after 9999 has been entered.*

## 7 The Main Menu

The **MAIN MENU** is accessed by pressing



```

MAIN MENU

0:ALARMS  1:STAGE 1 ALARMS  2:PRE-ALARMS
3:FAULTS  4:DISABLES        5:WALK TESTS
6:STATUS  7:TOOLS           8:SETUP
9:ABOUT
SELECT NO.
AC:2Z     ALM:0  PALM:0  FLT:0  DIS:0
    
```

Figure 22: The Main Menu (No Network)

**Numbering System:** ❶ denotes the menu structure number, ① denotes the sub-menu numbering, ① denotes a sub-menu within a sub-menu and ① denotes another sub-menu within a sub-menu

Pressing the appropriate number on the keypad while in the MAIN MENU the user can view any;

### 7.1 Alarms



Pressing ❶ Displays all Alarms present on the system.

```

ZONE: 1
Zone 1
STATUS: ALARM
`DATE' `TIME'

ZONE ALARM 1 OF 1
                                DEVICE>
AC:2Z     ALM:0  PALM:0  FLT:0  DIS:0
    
```

Figure 23: The ALARMS display

Pressing the  will display the Device Information the screen, pressing the  will return it to Zone Information

### 7.2 Stage 1 Alarms



Pressing ❶ Displays all Stage 1 Alarms present on the system

```

ZONE: 1
Zone 1
STATUS: STAGE 1 ALARM
`DATE' `TIME'

ZONE STAGE 1 ALARM 1 OF 1
                                DEVICE>
AC:2Z     ALM:0  PALM:0  FLT:0  DIS:0
    
```

Figure 24: The STAGE 1 ALARMS display

Pressing the  will display the Device Information the screen, pressing the  will return it to Zone Information

### 7.3 Pre-Alarms



Pressing **2** Displays all Pre-Alarms on the system

```

ZONE: 1
Zone 1
STATUS: PRE-ALARM
'DATE' 'TIME'

ZONE PRE-ALARM 1 OF 1
                                DEVICE>
AC:2Z   ALM:0   PALM:0   FLT:0   DIS:0
    
```

Figure 25: The PRE-ALARMS display

Pressing the  will display the Device Information the screen, pressing the  will return it to Zone Information

### 7.4 Faults

Pressing **3** Displays all Faults on the system

```

FAULT MENU

0:ZONE/DEVICE      1:LOOP          2:MODULE
3:P/SUPPLY         4:BRIGADE       5:TFAILS
6:SOUNDERS         7:ADD ONS       8:SYSTEM

SELECT NO.
AC:2Z   ALM:0   PALM:0   FLT:0   DIS:0
    
```

Figure 26: The Fault Menu display (no network)

```

FAULT MENU

0:ZONE/DEVICE      1:LOOP          2:MODULE
3:COMMS            4:P/SUPPLY      5:BRIGADE
6:TFAILS           7:SOUNDERS      8:ADD ONS
9:SYSTEM

SELECT NO.
AC:2Z   ALM:0   PALM:0   FLT:0   DIS:0
    
```



Figure 27: The Fault Menu display (Network configured)

```

ZONE: 1
Zone 1
STATUS: FAULT
'DATE' 'TIME'

ZONE FAULT 1 OF 1
                                DEVICE>
AC:2Z   ALM:0   PALM:0   FLT:0   DIS:0
    
```

Figure 28: The FAULTS display

Pressing the  will display the Device Information the screen, pressing the  will return it to Zone Information

### 7.5 Disables



Pressing **4** Displays all Disables on the system.

```

ZONE: 1
Zone 1
STATUS: DISABLE
'DATE' 'TIME'

ZONE DISABLE 1 OF 1
                                DEVICE>
AC:2Z   ALM:0   PALM:0   FLT:0   DIS:0
    
```

Figure 29: The DISABLES display

Pressing the  will display the Device Information the screen, pressing the  will return it to Zone Information

**Note:** If there are no alarms, pre-alarms, faults or disables, a message, e.g. 'NO ZONES OR DEVICES IN ALARM OR SOUNDERS OR ADDONS DISABLED', will be displayed for 1 to 2 seconds and then the display will return to the Main menu.

```

NO ZONES OR DEVICES OR
SOUNDERS OR ADDONS DISABLED

AC:2Z   ALM:0   PALM:0   FLT:0   DIS:0
    
```

Figure 30: No Zone or Devices Sounders or Addons disabled screen

### 7.6 Walk Tests



Pressing **5** Displays all Walk Tests on the system

```

ZONE: 1
Zone 1
STATUS: WALK TEST

                                TERMINATE<KEY 0>
ZONE WALK TEST 1 OF 1
                                DEVICE>
AC:2Z   ALM:0   PALM:0   FLT:0   DIS:0
    
```

Figure 31: The WALK TEST display

Pressing the  will display the Device Information the screen, pressing the  will return it to Zone Information

## 7.7 Status

Pressing 6 Displays the Status of the system

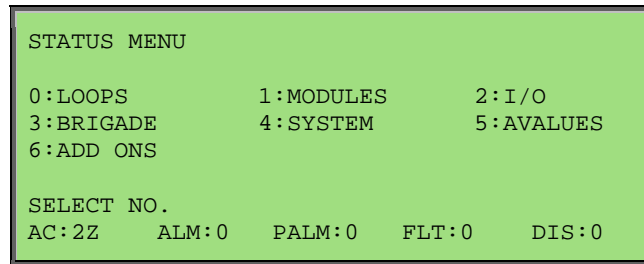

Figure 32: The Status Menu (No networking)

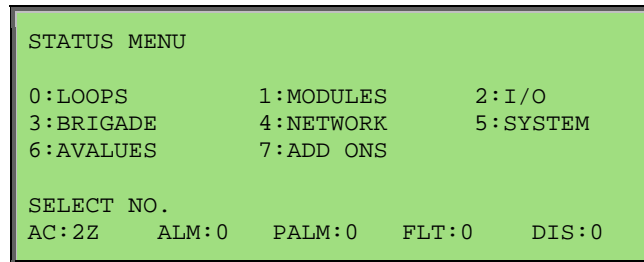

Figure 33: The Status Menu (Networking)

From the STATUS MENU the status of system components and settings can be selected and displayed as listed below.

**Note:** Different screens are displayed for a system with and without networking.

Press

① **Loops:** Enter the loop number and the LCD will display its status, e.g. normal, type of fault etc. The Loop current draw and noise levels will also be shown in panels that have Slave CPU software version V9.0 or higher

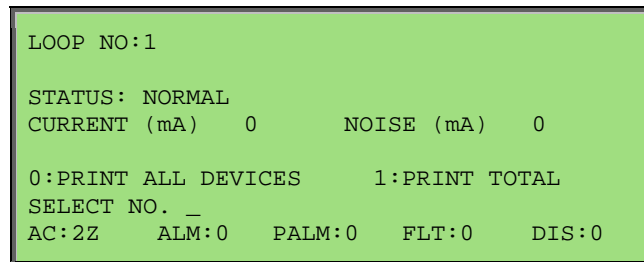

Figure 34: Display Loop Status

① **Modules:** Select the type of module, Slave ① and P/S ①

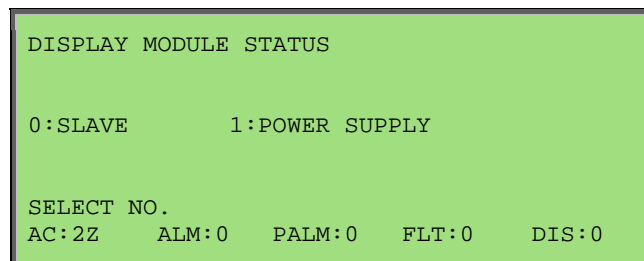

Figure 35: The Display Module Status display

② **I/O:** The LCD will display the status of an input or output in a panel or on a loop, Outputs ① and Inputs ①.

```

DISPLAY INPUT/OUTPUT STATUS

0:OUTPUTS          1:INPUTS

SELECT NO.
AC:2Z   ALM:0   PALM:0   FLT:0   DIS:0
    
```

Figure 36: The Display I/O Status display

```

DISPLAY OUTPUT STATUS

0:IN A PANEL       1:ON A LOOP

SELECT NO.
AC:2Z   ALM:0   PALM:0   FLT:0   DIS:0
    
```

Figure 37: The Display Output Status display

Once entered the LCD will then display a description of what that input or output does and its current state.

- ③ **Brigade:** Displays the Brigade Status

```

BRIGADE STATUS (NP: 1)
NIC VERSION: 0.0.00.00
OUTPUT 1: (FIRE ) OFF /NORM
OUTPUT 2: (FAULT ) OFF /NORM
OUTPUT 3: (SOUNDER ) OFF /NORM
OUTPUT 4: (SOUNDER ) OFF /NORM
PRESS > FOR INPUTS/RELAYS/AUXS
AC:2Z   ALM:0   PALM:0   FLT:0   DIS:0
    
```

Figure 38: Display Brigade Status

- ④ **Network:** Displays Network Status.

**Note:** This option is only available if the system configuration is networked.

Is pressed to gain access to NETWORK STATUS.

```

DISPLAY NETWORK STATUS
NIC VERSION: 0.0.00.00

0:NETWORK POINTS
1:REMOTE SLAVE MODULES
SELECT NO.

AC:2Z   ALM:0   PALM:0   FLT:0   DIS:0
    
```

Figure 39: Display Network Status

① Network Points:

```
DISPLAY NETWORK POINTS

0:STATUS    1:POWER SUPPLY    2:BRIGADE

SELECT NO.

AC:2Z      ALM:0    PALM:0    FLT:0    DIS:0
```

Figure 40: Display Network Points

**Network Points Screens are**

- ① **STATUS:** Press, Select network point e.g. Loop Number
- ① **POWER SUPPLY:** Press to display Charger Volts, Battery Detected and Mains OK
- ② **BRIGADE:** Press to display Operational or Non-Operational

① Remote Slave Modules:

Select from Network Status Remote Slave Modules, then Module number.

```

Apollo Loop 1
TYPE:APOLLO      LOOP NO:1      VER: 6.1
NP:1            MOD:4          STAT:NORMAL
REMOTE MODULE   STATUS

AC:2Z      ALM:0      PALM:0      FLT:0      DIS:0
    
```

Figure 41: Display Remote Module Status

 **Note:** The SYSTEM, AVALUES and ADD-ONS will increment by 1 if the network is configured

④/⑤ **SYSTEM:** Is pressed to access SYSTEM STATUS

```

SYSTEM STATUS
ALARMS:000 PRE-ALARMS:000  DISABLES:000
DEVICE FAULTS:00          MOD FAULTS:00
LOOP FAULTS:00           EXTRA DEVICES:00
WALK TEST:00             WDOG:00
APP: V 1.0   EN54
CONFIG:
AC:2Z      ALM:0      PALM:0      FLT:0      DIS:0
    
```

Figure 42: Display System Status

⑤/⑥ **AValues:** Is pressed to access AVALUES.

Select Loop Number and device number to show AVALUES

```

Loop 1      sensor 1

L1   S1   Z2
STAT: NORMAL
AVALUE:25      MODE:0      I:000      O:000

0:PRINT ENTRY
AC:2Z      ALM:0      PALM:0      FLT:0      DIS:0
    
```

Figure 43: Analogue Values

⑥/⑦ **ADD-ONS:** Is pressed to access MODULE status

```

DISPLAY ADD-ON MODULE STATUS

NODE: 000
MODULE (1-32):

SELECT ADD-ON MODULE NO. THEN ENTER KEY

AC:2Z      ALM:0      PALM:0      FLT:0      DIS:0
    
```

Figure 44: Add on Module status



## 7.8 Tools

Pressing ⑦ allows for the Testing of the following selected fields

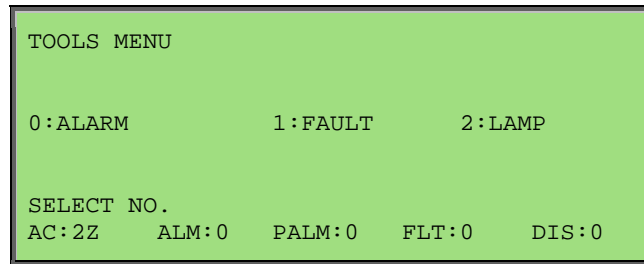

Figure 45: The TOOLS menu

Pressing ⑩ brings up a further detailed selection sub-menu for an Alarm tests.

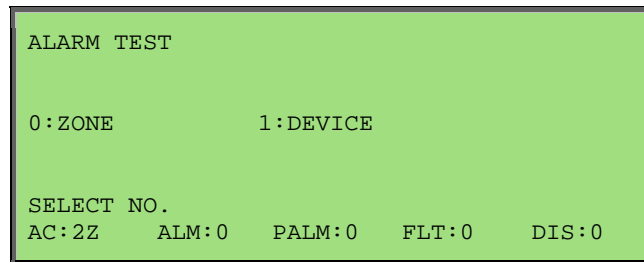

Figure 46: The ALARMS test menu

Pressing ⑪ brings up a further detailed selection sub-menu for a Fault tests.

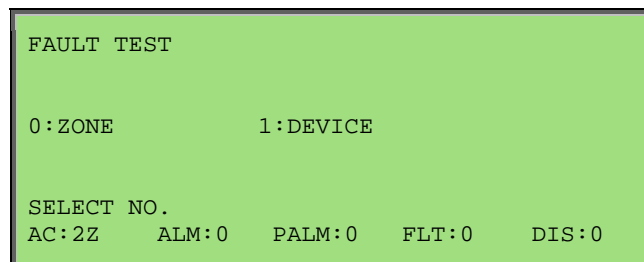

Figure 47: The FAULT test menu

Pressing ⑫ initiates a LAMP Test. Which will scroll thru and illuminate all LED's and LCD screen

## 7.9 Setup

Pressing ⑧ Displays the setup for sounders, Zone Delay and Printer

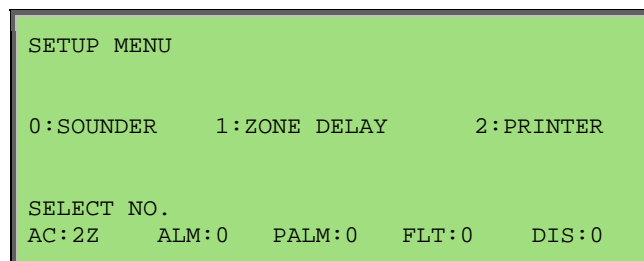

Figure 48: The SETUP menu

Pressing ⑬ brings up a further detailed selection sub-menu for Sounder O/P's.

```

SOUNDER MENU

0:SOUNDER ENABLE          1:SOUNDER DISABLE
2:SOUNDER RE-TRIGGER(ON)
3:SOUNDER RE-TRIGGER(OFF)
CURRENT STATUS: ENABLE / RE-TRIGGER (ON)
SELECT NO.
AC:2Z   ALM:0   PALM:0   FLT:0   DIS:0
    
```

Figure 49: The SOUNDER menu

Pressing ② and ③ require access level 3.

Pressing ① brings up a further detailed selection sub-menu for Zone delays

```

ZONE DELAY MENU

0:ALL ZONE DELAY ON 1:ALL ZONE DELAY OFF

CURRENT STATUS: DELAY ON

SELECT NO.
AC:2Z   ALM:0   PALM:0   FLT:0   DIS:0
    
```

Figure 50: The ZONE DELAY menu

Pressing ② brings up a further detailed selection sub-menu for Printer

```

PRINTER MENU

0:GO OFF-LINE / GO ON-LINE

1:ALARM MODE ONLY

SELECT NO.
AC:2Z   ALM:0   PALM:0   FLT:0   DIS:0
    
```

Figure 51: The PRINTER menu

The GO OFF-LINE and GO ON-LINE is a toggle option

### 7.10 About

Pressing ⑨ Displays the panel’s application software version number and the title information. Title information could be company name, contact information and so on.

```

ABOUT MENU

VERSION#:1.01.00.AS7240
AMPAC TECHNOLOGIES

AC:2Z   ALM:0   PALM:0   FLT:0   DIS:0
    
```

Figure 52: The About menu

## 8 The Function Menu

The **FUNCTION MENU** is accessed by pressing  button.

A prompt will ask for a **PASSWORD** if the control panel is not currently active. Using the keypad key in the Level 2 or 3 **PASSWORD**.

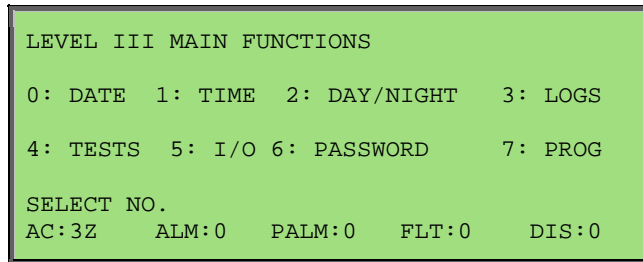



Figure 53: The Level II & III Functions Menu

### 8.1 Date

Press **0** To select the set **DATE SCREEN**. The prompt will ask for the date to be entered in this format, **DD/MM/YYYY** (EG 01/01/2011), key in and press . The screen will then return to the **MAIN FUNCTIONS MENU**.

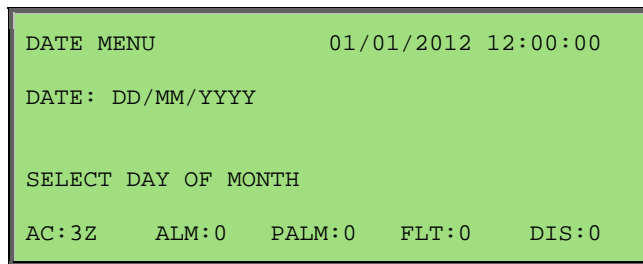



Figure 54: DATE Menu

### 8.2 Time

Press **1** To select the set **TIME SCREEN**. Then in the following format key in the time, **HH:MM** using the 24 hour mode. Press  and the screen will return to the **MAIN FUNCTIONS MENU**.

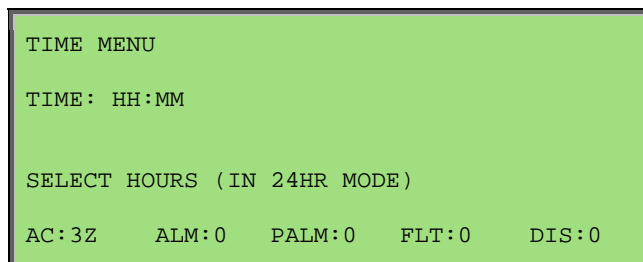

Figure 55: TIME Menu

### 8.3 Day/Night

Press ② The **DAY-NIGHT SETTINGS** screen will appear. Time entry is the same as setting the "Time" facility. Note this Function is available at Access Level 3 only.

Press ① To enter the **DAY ON** time.

Press ① To enter the **NIGHT ON** time.

Press ② To **ENABLE / DISABLE**

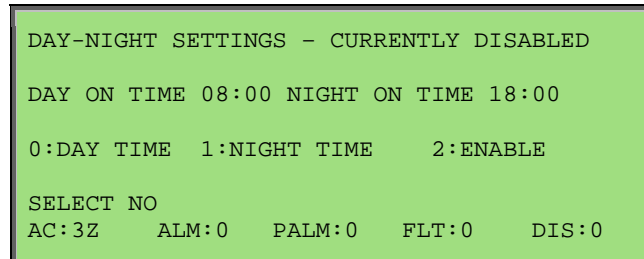

Figure 56: DAY-NIGHT SETTINGS Menu

For this Function to have control it must be **ENABLED** by press ② Re-pressing ② will toggle to **DISABLE**.

### 8.4 Logs

Press ③ to access the **EVENT LOG MENU** will be displayed.

The **LOGS MENU** allows the operator to select and view the events that have occurred.

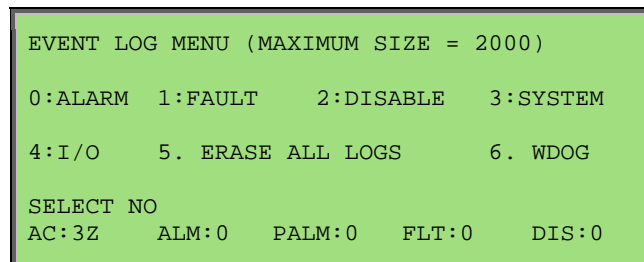
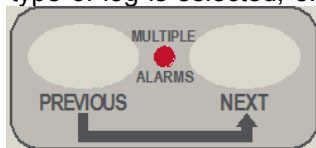

Figure 57: DAY-NIGHT SETTINGS Menu

Once the type of log is selected, e.g. **FAULT**, each entry can be viewed by stepping through them



using the buttons

Pressing ⑤ and ⑥ require access level 3.

The type of log, number and totals logged, date and time of the **ALARM**, **FAULT**, **DISABLE**, **SYSTEM** or **I/O** as well as device information will be displayed. The **SYSTEM** screen displays events and watchdog activity. From these screens the operator can select two other facilities, they are;

① **PRINT ENTRY** will print out the displayed information if a printer is installed, or

① **SHOW OPTIONS** allows the operator to select how the Logs are viewed.

① To **VIEW BY ENTRY NUMBER**, ① to **VIEW BY DATE** or ② to **PRINT MULTIPLE ENTRIES**. In each case the screen will ask for the appropriate information (**ENTRY NUMBER** or **DATE**) to be entered before the selected option will be displayed.

## 8.5 TESTS

Press **4** to access the TESTS menu. Note this is an Access Level 3 function only.

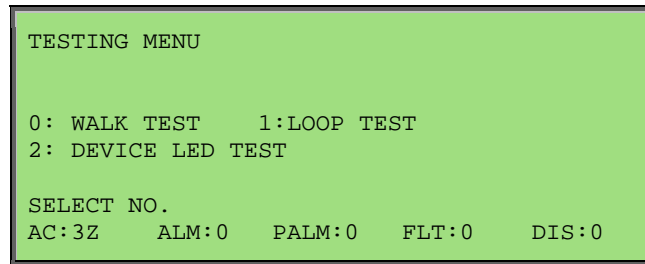

Figure 58: The Testing Menu

Press **0** Is pressed to initiate a **WALK TEST**:

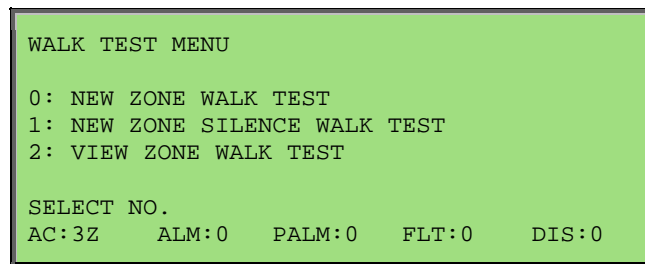

Figure 59: The Testing Menu

When in walk test the  indicator is on.

Press **1** **LOOP TEST** requires the operator to select a **LOOP** for **DIAGNOSTIC TESTING**

Entering the LOOP number and pressing  will initiate the **DIAGNOSTIC TEST**.

 **Note:** The LED's on the Brigade Board will indicate which leg is being tested.

**The tests displayed are;**

- TESTING SIDE A IDENTIFYING DEVICES on SIDE A, and
- TESTING SIDE B IDENTIFYING DEVICES on SIDE B.

Once the testing is completed the final screen will display the number of devices found and tested on the LOOP and a Reset is requested to return the system to normal.

 **Note:** If the data is not entered within 2 minutes the screen will time out and return to the **DEFAULT SCREEN**.

 **Note:** A Loop Test needs to be conducted after a short / open circuit has occurred, corrected and cleared to return the panel to its default Normal status otherwise the panel will display a loop fault.

Press **2** to initiate a **DEVICE LED TEST**:

This allows the user to turn on a device LED. Cancel out of the Device LED test screen will automatically turn off the device LED. If the device LED test screen is left on after 30 minutes the LED will turn off and the panel return to the Normal screen.

8.6 I/O

Press 5 To display the Manual I/O Control menu

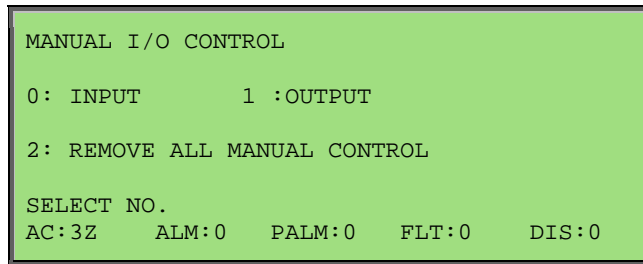

Figure 60: The Manual I/O Control Menu

Manual I/O control allows the technician to turn ON or OFF inputs and outputs off a device to facilitate testing or isolation of plant during maintenance. Removal of manual control returns control to the panel.

Press

0 Input Selected:

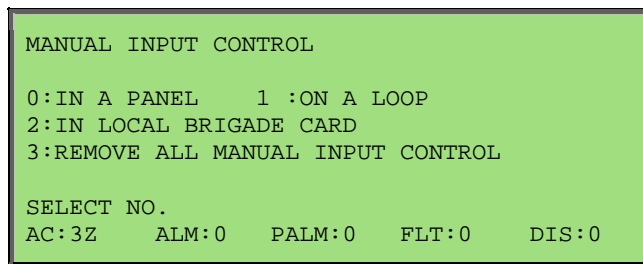

Figure 61: The Manual Input Control Menu

Press

0 IN A PANEL: Enter the I/O Controller number then the input number. This will display the description for the input and its current state, you can then turn the input ON or OFF or remove manual control.

1 ON A LOOP: Enter the loop number, the device number and the input number. This will display the description for the input and its current state, you can then turn the input ON or OFF or remove manual control.

2 IN LOCAL BRIGADE CARD: Will bring up the list and status of the Brigade card Inputs. These can then be manually turned on and off with the exception off the MCP configured input

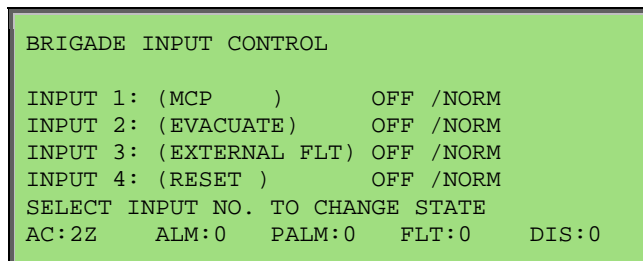

Figure 62: Brigade Input Controls

3 Remove All Manual Input Control: Will remove all manual input control.

1 Output Selected: Same sequences as above for inputs but substitute outputs for inputs.

2 Remove All Manual Control Selected: Globally removes all manual control.

## 8.7 Global (Network Panels)

Press **6** To display the Global Output Control menu

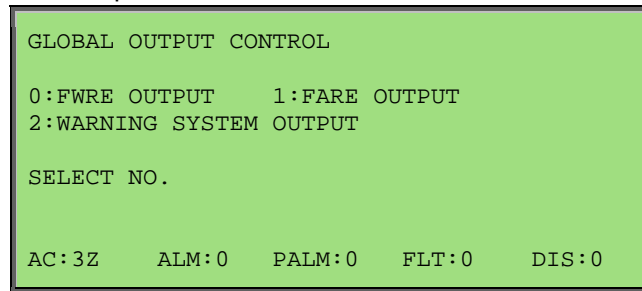

Figure 63: The Global Output Control Menu

Press

### ① FWRE OUTPUT:

Provides control to disable or enable the FWRE outputs. Press

① ENABLE

① DISABLE

### ① FARE OUTPUT:

Provides control to disable or enable the FARE outputs. Press

① ENABLE

① DISABLE

### ② WARNING SYSTEM OUTPUT:

Provides control to disable or enable the warning system outputs. Press

① ENABLE

① DISABLE

## 8.8 Passwords (Level III)

Press

⑥ While in the Main Functions menu and enter the Level III Password if in Access Level II or, if in Access Level III to display the Password Menu.

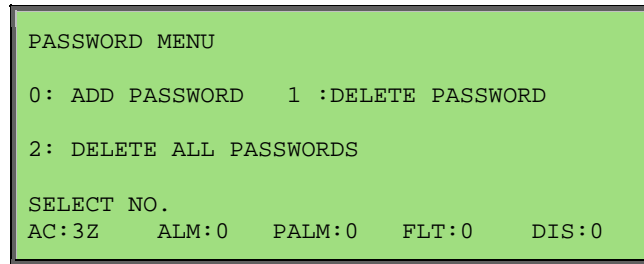





Figure 64: The Password Menu

① **Add Password:** Enter the new password, then press . The password is always a 4 digit number.

① **Delete Password:** Enter the password that you want to delete, then press .

② **Delete All Passwords:** This asks you to confirm that you want to delete all the passwords.  
Press  then  again.

③ **Zone / Device Mode:** This sets the mode in which Alarms, Faults, Pre-Alarms and Disables status information will be displayed. “Zone” is the default setting.



## 8.9 Programming

Press **7** To display the Level III Programming Menu.

```

ON SITE PROGRAMMING MENU

0: CONV ZONE 1 :DEVICE 2:INPUT 3: OUTPUT
4: PANEL BASED MCP 5:SUB ADDRESS
6:ZONE PROGRAMMING

SELECT NO.
AC:3Z   ALM:0   PALM:0   FLT:0   DIS:0
    
```

Figure 65: Programming Menu

### 8.9.1 Conv (Conventional) Zone

Press **0** CONV ZONE:



Key in the zone number and enter or change the description (**DESC**) by pressing buttons to move the flashing underline or cursor. The numeric buttons multiple times to access characters while at the same time using

```

EDIT Zx DESC AND TYPE STRINGS
DESC < ZONE >
TYPE<
ALPHA KEYS ARE ACTIVE

AC:3Z   ALM:0   PALM:0   FLT:0   DIS:0
    
```

Figure 66: Zone Description & Type Programming

Press  to move to the **TYPE** field or edit the information.

Press  to move between fields use the reciprocal button

By going through all the fields a second screen can also be accessed to show the Output options.

Press  to step through these fields.

```

EDIT ZX BRIGADE OPTIONS AND CONFIG
ALRM: Y/N BELL: Y/N AUX: Y/N SPRK: Y/N
AIF: Y/N
ALARM LED: Y/N CONFIG: LATCHING
Use < or > to change setting

AC:3Z   ALM:0   PALM:0   FLT:0   DIS:0
    
```

Figure 67: Brigade Options

The buttons  are used to set the Y/N field, which is the selected Zone that will activate the Brigade Options ALRM, BELL etc and Config.

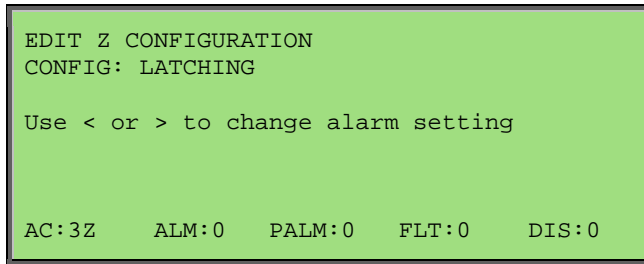

Figure 68: Zone Configuration Latching / Non-latching

Use  or  to change the setting

Configuration settings are Latching, Non-Latching, AVF, Self Reset ( 0 to 99 seconds ). After setting the Configuration the ZONE I/O GROUPS are programmed.

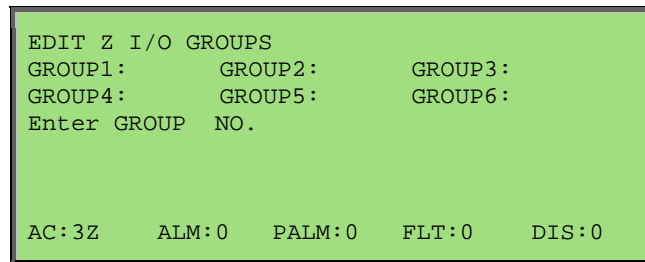



Figure 69: Zone I/O Groups

After scrolling through the groups and entering what I/O GROUPS will be turned on by what module/s or device/s in a zone/s the operator is prompted to press  to confirm the entries and / or changes.

### 8.9.2 Device



Press ① DEVICE:



Use these buttons to **EDIT** and move through wording & numbering





Use these buttons to **MOVE** between fields i.e.: DESC & TYPE and next parameter

Enter the  and  number then scroll through the following screens.

Press  or Press 

② To **EDIT** or ① to **DELETE**

1. EDIT LxSx DESCRIPTION AND TYPE STRING. Edit then. Press   
 e.g.: DESC Loop 1 Sensor 1  
**TYPE SMOKE**

2. Allocate / Edit the Device to a Zone and set the device type then. Press   
 e.g.: XP95 Photo, XP95 Heat etc-

3. Set /Edit and display the Output Configurations or options then. Press   
 e.g.: Latching, AVF, Non-latching etc

4. Set / Edits and enables / disables the day/night settings then. Press



5. Allocates / Edits the Loop and Devices Groups.







After scrolling through the groups a prompt tells the operator to press to confirm the changes.

### 8.9.3 Input

Press ② **INPUT:**

By following the screen prompts as above Edit or Delete an **INPUT** in a panel or a loop.

#### Screen: PROGRAM MENU SELECTING AN INPUT

② <b>IN A PANEL</b>	① <b>ON A LOOP</b>
<b>I/O MODULE</b>	<b>LOOP</b>
Select I/O MODULE <b>NO.</b> then 	Select <b>LOOP NO.</b> then 
<b>INPUT</b>	<b>DEVICE</b>
Select I/P <b>NO</b> then 	Select <b>DEVICE NO.</b> then 
<b>EDIT / DELETE DESC</b>	<b>INPUT</b>
	Select <b>INPUT NO.</b> then  button
ALPHA BUTTONS ARE ACTIVE	<b>EDIT Lx Sx I/Px DESC STRING DESC</b>

### 8.9.4 Output

Press ③ **OUTPUT:**

By following the screen prompts as above Add, Edit or Delete an output in a panel or on a loop.

### 8.9.5 Panel Based MCP

Press ④ to EDIT

### 8.9.6 Sub Address

Press ⑤ to EDIT

### 8.9.7 Watchdog

Press ⑥ This Function provides a counter to record any re-initialisation of the processor. If due to a software failure the panel is automatically reset then the counter will increment by 1. The maximum count is 99 after which the counter resets to 00. Pressing ① will reset the counter. When the panel is commissioned this counter **MUST** be reset to 0 as must be the **Events Logs**.

### 8.9.8 Zone programming

Press ⑦ to EDIT



Key in the zone number and select the key.

Enter or change the description ( **DESCR** ) by pressing buttons to move the flashing underline or cursor. Press the numeric buttons multiple times to access characters.

```

EDIT ZONE: 1      DESC STRING
DESCR<MY ZONE 1 DESCRIPTION

ALPHA KEYS ARE ACTIVE

[USE>> TO EDIT NEXT FIELD]

AC:3Z    ALM:0    PALM:0    FLT:0    DIS:0
    
```

Figure 70: Zone Programming - Description

Press the  key to edit the next field (Day Night Settings).

```

EDIT ZONE: 1      DAY NIGHT SETTINGS
DAY_NIGHT_ENABLE:    Y
DAY MODE SETTING:    A    TIMEOUT:  0
NIGHT MODE SETTING:  N    TIMEOUT:  0
[USE < OR > TO EDIT]
[USE << OR >> TO NAVIGATE]
AC:3Z    ALM:0    PALM:0    FLT:0    DIS:0
    
```

Figure 71: Zone Programming – Day/Night Setting 1

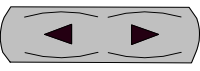
The keys  are used to set the:

- Y/N field for the "DAY\_NIGHT\_ENABLE"
- A/B/C/D/N field for the "DAY MODE SETTING" and "NIGHT MODE SETTING" where "A, B, C" refers to "Dependency A, B, C" respectively, "D" refers to "Delay to Outputs" and "N" refers to "Normal" (i.e. no mode setting).

The numeric buttons are used to edit the TIMEOUT fields.

```

EDIT ZONE: 1      DAY NIGHT SETTINGS
                                DAY / NIGHT
MCP OVERRIDE:          N /  N
DELAY ALARM DEVICE:    N /  N
DELAY FARE:            N /  N
[USE < OR > TO EDIT]
[USE << OR >> TO NAVIGATE]
AC:3Z    ALM:0    PALM:0    FLT:0    DIS:0
    
```

Figure 72: Zone Programming – Day/Night Setting 2

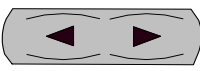
The keys  are used to set the Y/N field for the "MCP OVERRIDE, DELAY ALARM DEVICE, DELAY FARE".

```

EDIT ZONE: 1      CONFIRMATION

SELECT ENTER TO SAVE

AC:3Z    ALM:0    PALM:0    FLT:0    DIS:0
    
```

Figure 73: Zone Programming – Confirmation

Select the  key to confirm the changes.

### 8.9.9 Extra Devices Detected

The **FireFinder PLUS** LCD will indicate extra devices have been detected by displaying the screen below and the FAULT LED will be illuminated.

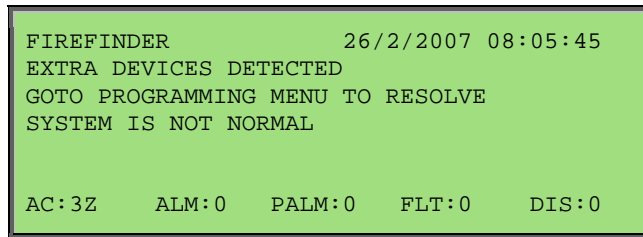

Figure 74: Resolving Extra Modules and Devices

To resolve select **FUNCTION**, enter **PASSWORD**, press **6** and the screen below will appear

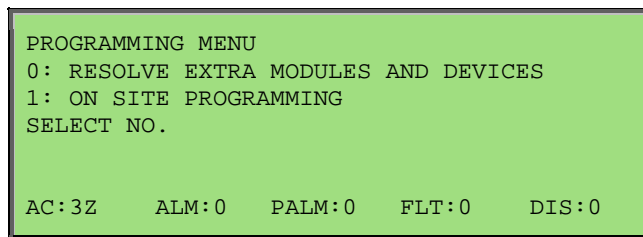

Figure 75: Added Module or Device

Select **0** (Selecting **1** presents the PROGRAMMING MENU) then **0** or **1** (as seen below) then ENTER to ADD the module or device to the configuration, or skip to resolve the changes manually in the Programming Menu.

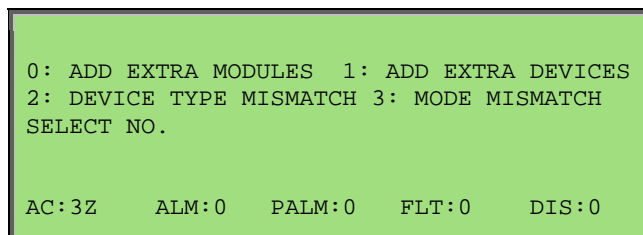

Figure 76: Resolving Extra Modules or Devices

### 8.9.10 Mismatch Detected

If a mismatch is detected the Normal Default Screen will change to that shown below. Go to the Programming Menu and select either **0** *Resolve Extra Modules and Devices* then **2**

(*Device Type*) or **3** (*Mode*) to resolve the mismatch, OR On Site Programming to resolve manually.

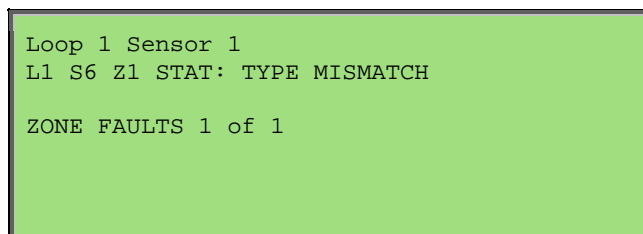



Figure 77: Resolving a Mismatch

Self Learn is enabled / disabled in the EEPROM programming. If enabled **FireFinder PLUS** has the ability to detect extra or missing modules or devices, (that is devices or modules that have been added or removed) or there has been a change of the type of module or device.

 **Note:** If a change does occur the FACP will take 30seconds to register the event on the LCD and illuminate the FAULT LED.

## 9 Incoming Fire Alarm Signal

- Will operate the red common LED fire indicator
- Will display location of fire alarm origin on the LCD
- Will activate external alarm.
- Will activate the internal FACP buzzer.
- Will activate any ancillary equipment so programmed.
- Will abort any test in progress.

The LCD will always display the first fire alarm signal received in the top section of the LCD. The lower section of the LCD will also permanently display the most recent zone in alarm. Other essential fire alarm information and fault or disablement information is available via the

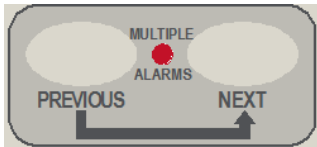

buttons. After 30 seconds if no button is pressed the top section of the display will revert to displaying the first zone in alarm.

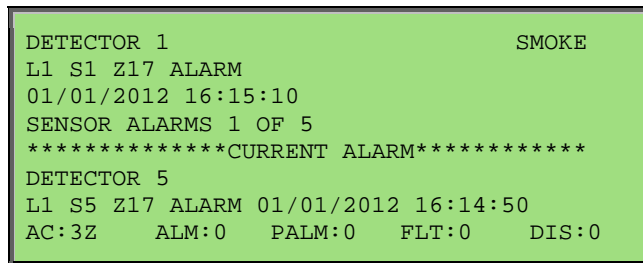
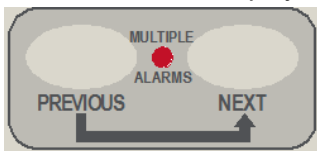

Figure 78: LCD Screen with 5 Devices in Alarm



**Note:** The displayed information changes to that associated with the device as the









push buttons are pressed. If there is a fault condition or a fire alarm and





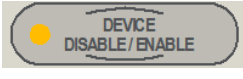

the buzzer is sounding, press the button to stop it sounding

## 10 Accessing a Loop, Device or Zone

### LOOP OR DEVICE

- From the default display, press .
- Enter the loop number you wish to interrogate then press .
- Press the button for the device number.
- Press the  button if you wish to access a range of devices on the loop,
- Press the  button if you wish to display the status of a device,
- Press the  button if you wish to disable a device
- Press the  button to re-enable a device.

### ZONE

- From the default display, press .
- Press the button for the zone number.
- Press the  button if you wish to access a range of zones,
- Press the  button if you wish to display the status of a zone,
- Press the  button if you wish to disable a zone
- Press the  button to re-enable a zone.

## 11 Modem / Programming / Debug Interfacing

The modem I/O port is a Dual DB9 connector (CN8 situated on the lower left hand corner of the Main Board BRD86MBA) that is normally used for programming of the FACP via the serial port of a PC or Laptop. There is also a USB connector (CN25) provided to allow programming of the FACP from a USB port of a PC.

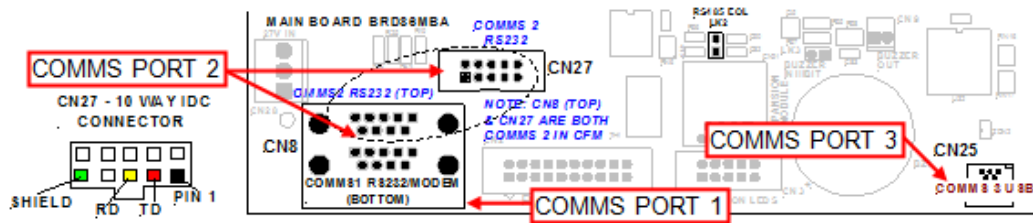

Figure 79: DB9 Connector CN8 as Mounted on the Main Board

The Controller also has the required hand shaking to support connection to a Modem, thus allowing the FACP to be programmed from a remote site that has an established telephone connection. This allows the system software to be upgraded by simply transmitting a file via the serial port of the PC or Modem external to the FACP. Diagnostic facilities are also available via the same connection.

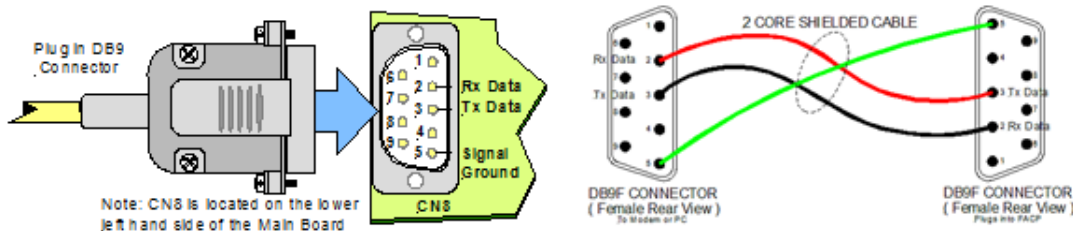

Figure 80: Modem / Programming / Debug Cabling



Figure 81: USB cable Type A Male Plug - Type B 5-Pin Mini Plug

**Note:** Debug/Notebook cables are available from AMPAC

**Note:** the DB9F to DB9F cable is not sensitive to which end is plugged in to the **FireFinder PLUS** or serial port of the PC or vice versa.

The connections between the PC/Modem and the panel are crossed. i.e. TD connects to RD.

Make sure the **ConfigManagerPlus** program is set to use the port you have connected the cable to and set up the configuration as follows:

<b>Bits per second:</b>	115200
<b>Data bits:</b>	8
<b>Parity:</b>	None
<b>Stop bits:</b>	1
<b>Flow Control:</b>	None



## 12 Expanding the FACP with Compatible FireFinder PLUS Boards

### 12.1 Ancillary Services

The FACP has been designed such that detectors and/or call points, in addition to giving an alarm and calling the fire brigade, will close or open circuits of ancillary services by means of relays or similar devices.

Examples of these services are:

- Actuation of fixed fire-extinguishing systems
- Closing of windows, smoke and fire doors
- Control of ventilating systems
- Covering of tanks containing flammable liquids and controlling their valves to isolate the contents from direct contact with the fire, etc.

To facilitate safe maintenance of these services an option is available that allows for the isolation and visual indication of the disablement of ancillary services that does not affect the normal operation of the fire alarm system.

To ensure power to the fire alarm system is not prejudiced in any way, power for the ancillary services must be included in the calculation of the power supply and battery capacity.

### 12.2 Compatible FireFinder PLUS Boards

Add- On Module / Board	Max No
Brigade Board	1 Per Controller
8 Zone Conventional Card	15 per Controller
32 Zone Alarm Mimic Card	15 per Controller
8 Way Relay Board	15 per Controller
Smart terminal	31 per Controller
Agent release module	8 per Controller
4 way Fire Fan Module with Reset	15 per Controller
4 way Fan Control (Loop driven)	15 per Controller
8 way Switch and Indicator Card	15 per Controller
16 Way Input Board	15 per Controller
High Level Interface Expander	3 per Controller
8 Way Sounder Board	15 per Controller
Zone Control Card	15 Per Controller
Conventional Network Board	1 Per Controller
Printer	1 per Controller
Expansion Board	1 per Controller
Network Interface Card	1 per Controller
Apollo / Dual Loop Termination Board	8 Per Controller
Communication Extender Board	1 per Controller

 **Note:** The Max Numbers of modules/boards that can be installed and configured within the FACP depends on the cabinet size and the number of Panels in the System.

 **Note:** Refer to individual Product datasheets and installation guides for complete details.

### 12.3 Expansion Board

The Expansion Connection Board (BRD86FEPB) is used to increase the capacity of the controller from 4 Slave CPU's to 8 allowing Loops 5 – 8 to be configured. Connection from the Controller to the Expansion Board, which must be mounted within 200mm of the Controller, is made via a 20 way flat cable Slave CPU number 5 is an integral part of the Expansion Board, only Slave CPU's 6, 7 and 8 are plug ins.

#### Connections

<b>CN1</b>	To Main Connection Board
<b>CN2</b>	To Slave CPU 2
<b>CN3</b>	To Slave CPU 3
<b>CN4</b>	To Slave CPU 4
<b>CN5</b>	On board Slave CPU

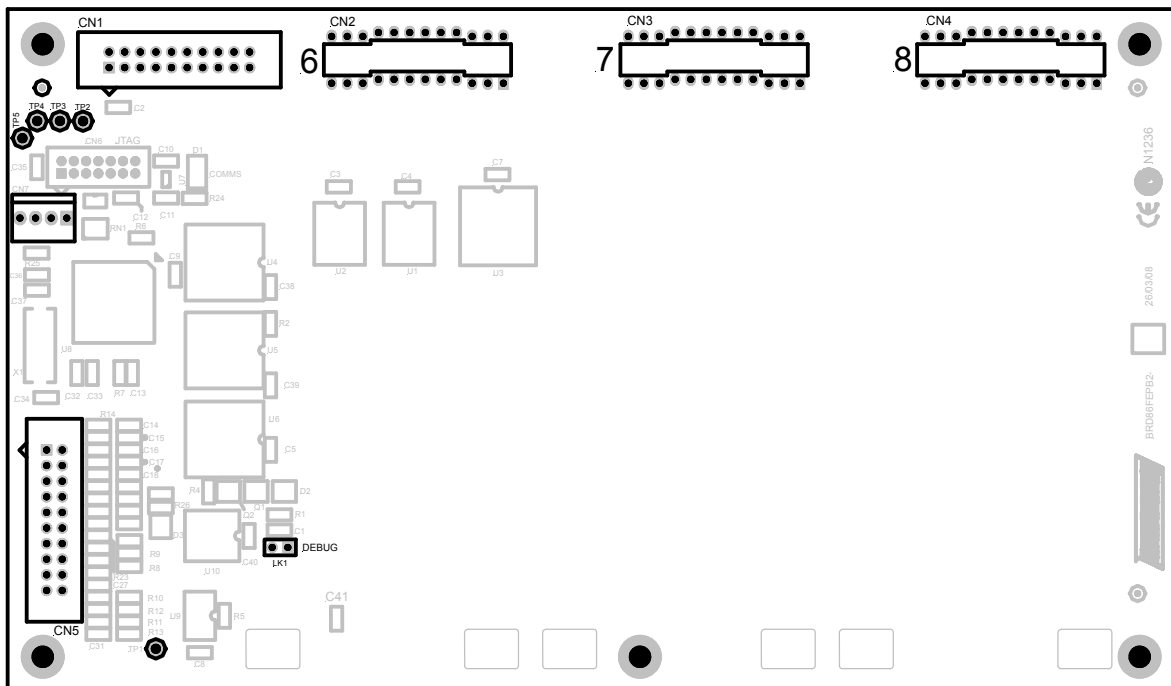

Figure 82: Board Overlay

### 12.4 8 Zone Conventional Board

This board (BRD43Ezc) has 8 conventional zones. Up to 999 zones max may be configured.

The zones may be used in panel programming and Input / Output programming.

The end of line type used for the board is configurable to be any one of the following:

- 3k3 resistor
- 10uF bipolar capacitor (EN54 Default)
- 4k7 resistor
- 6k8 resistor
- 10k resistor

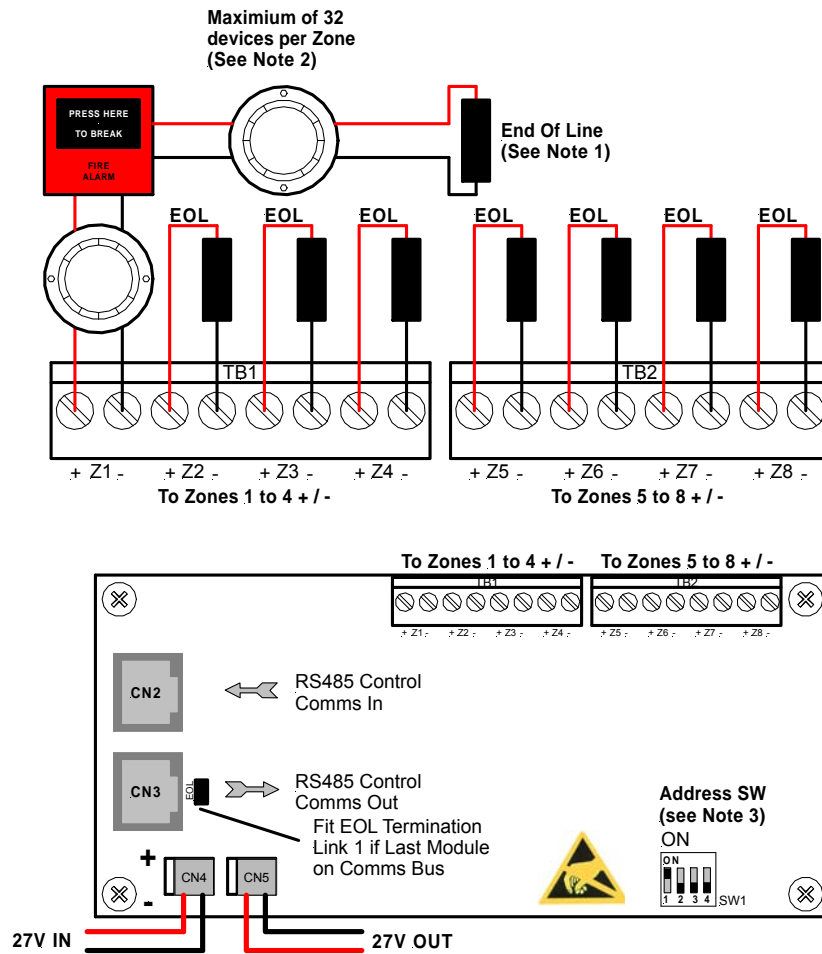

Figure 83: 8 Zone Conventional Board

#### Connections

Terminal/s	Function
TB1 to 2	ZONE + ZONE -
	Zones1 to 8

**Note 1:** Each Zone circuit MUST be terminated with either a 3K3, 4K7, 6K8, 10K Ohm resistor or 10uF 50V Bi-Polar Capacitor EOL

**Note 2:** If Diode Bases are used ONLY the 10uF CAP can be used.

**Note 3:** See Section 18 for Addressing Details (SW1)

### 12.5 32 Zone Alarm Mimic Card

Each card (BRD43ZAMC) has 32 bi-coloured LED's which can be used to display the status of up to 32 Zones. The zone numbers assigned to each LED are configurable and the LED's will operate in the following manner for the respective zone statuses:

ZONE STATUS	LED STATE	LED COLOUR
FIRE	ON STEADY	RED
DEPENDENCY B	FLASH	RED
DISABLED	ON STEADY	YELLOW
FAULT	FLASH	YELLOW
ALL OTHER	OFF	n/a

The card will also respond to a lamp test when instigated on the panel to which it is connected.

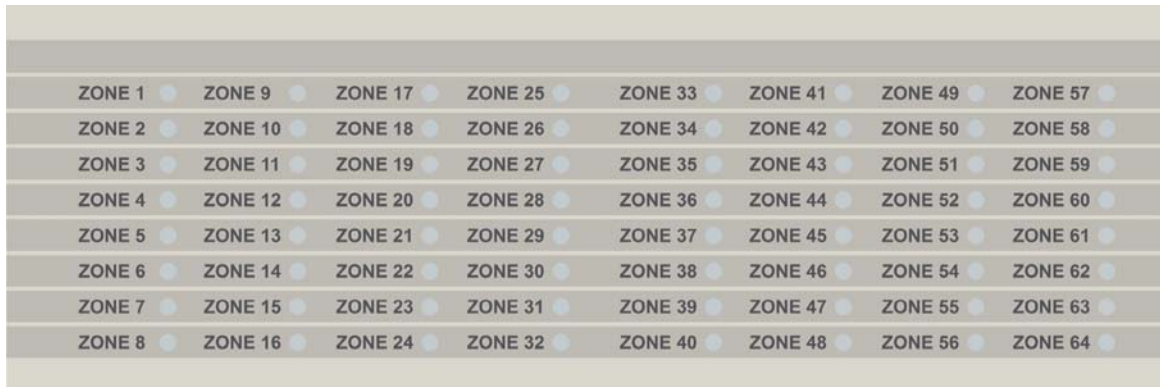

Figure 84: 64 Zone Indicator Decal

When more than 64 zone indicators are required the Zone Mimic Card board will be fitted to ENC1824 and fitted to the individual Cut Outs provided on the SP8 front door

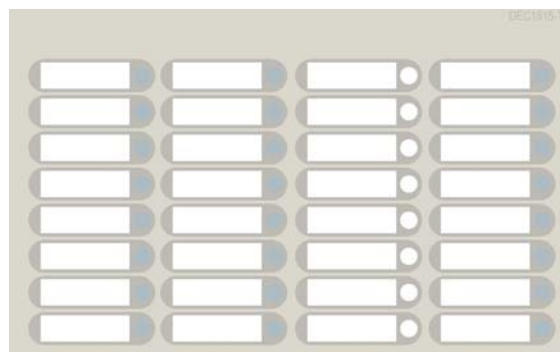

Figure 85: DEC1515-T2 Zone Indicator Decal (See LAB1516.doc for Slip in Label)

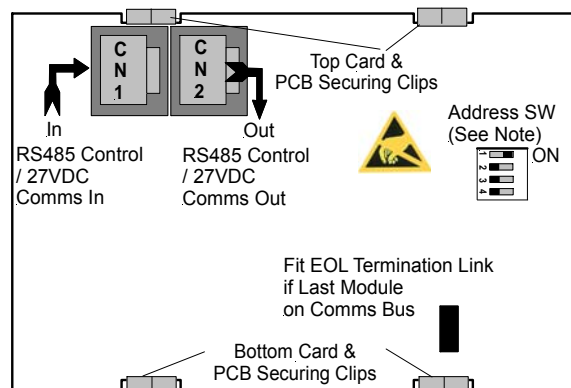

Figure 86: Zone Alarm Mimic Card Rear View showing connectors and Address Switch

**Note:** See Section 18 for Addressing Details (SW1)

### 12.6 8 Way Switch and Indicator Card

This card (BRD25GIB-B) has 8 switch inputs and 8 LED indicator outputs.

The switch inputs and LED outputs may be used in Input Output programming.

The switches are configurable as either momentary or toggle switches. When configured as momentary pressing the button once will cause an event to occur as programmed in I/O and the LED's can be programmed to operate as an output.

When configured as toggle, pressing the button once will cause a condition to be held until the button is pressed again. The associated LED is not available as an output in and shall always be illuminated when the toggle condition is active. Also, when configured as a toggle, there shall be an option for a timer override. If the toggle switch is activated it shall be de-activated automatically after the timeout period.

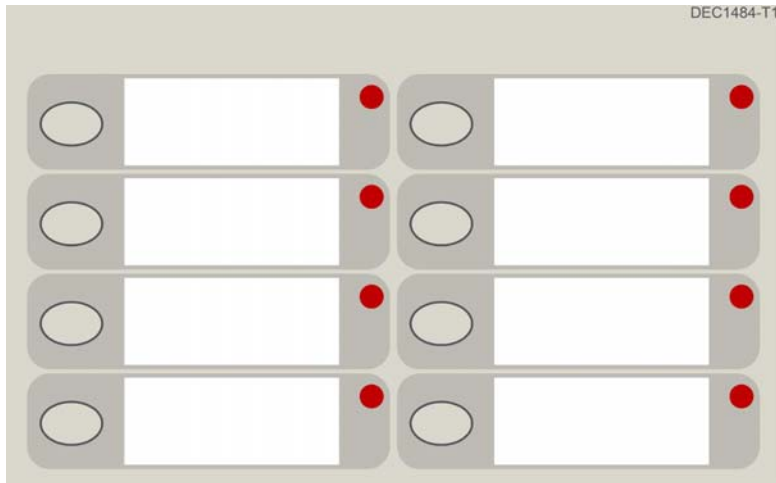

Figure 87: DEC1484-T1 8 Way Switch and Indicator Card Decal (See LAB1483.doc for Slip in Label)

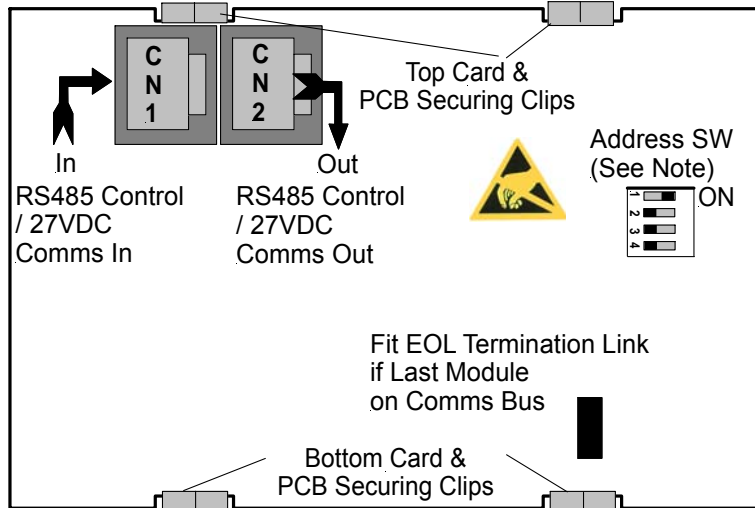

Figure 88: 8 Way Switch and Indicator Card Rear View showing connectors and Address Switch

**Note:** See Section 18 for Addressing Details (SW1)

### 12.7 16 Way Input Board

The 16 Way Input Board (BRD25SIP) makes provision for 16 voltage free contacts to be terminated to 16 optically coupled inputs. Its application is primarily for the monitoring of controlled ancillary equipment or to initiate an action / event due to a change of state from what is accepted as the norm.

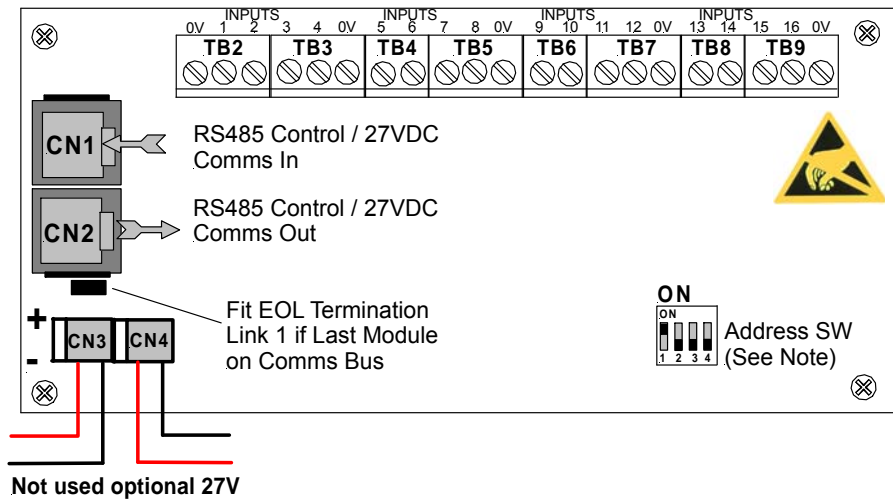
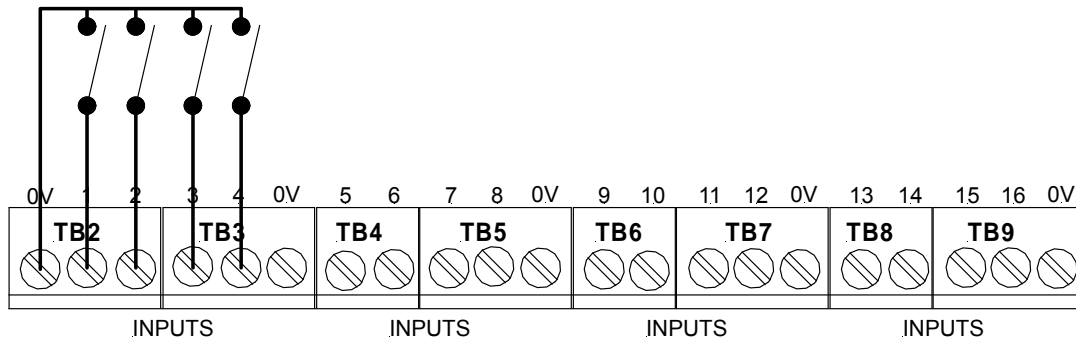

Figure 89: Typical Input Wiring and Board Layout Front View showing connectors and Address Switch

#### Connections

Terminal/s	Function
TB2 to 9	Taking note of the Common 0v terminals connect the voltage free contacts as shown above. Inputs 1 to 16

**Note:** See Section 18 for Addressing Details (SW1)

### 12.8 8 Way Relay Board

The Relay Board (BRD25EWRB) provides 8 programmable relays with 30VDC 1 Amp voltage free change over contacts for control or monitoring purposes and comes fitted for internal or external FACP use.

The functionality and programming of the relays is similar to the relays on the main board of the FACP. By default the relays default to Common Alarm functionality.

All terminal points are protected.

The board switches the relays as determined by the panel. The relays can be controlled by:

- Zones Alarm
- Group Alarm
- Device Alarm
- Internal Output
- Panel Output
- Loop Output
- Panel Input
- Loop Input
- Reset – relay is activated for 3 seconds when reset depressed

#### 12.8.1 Internal Relay Board

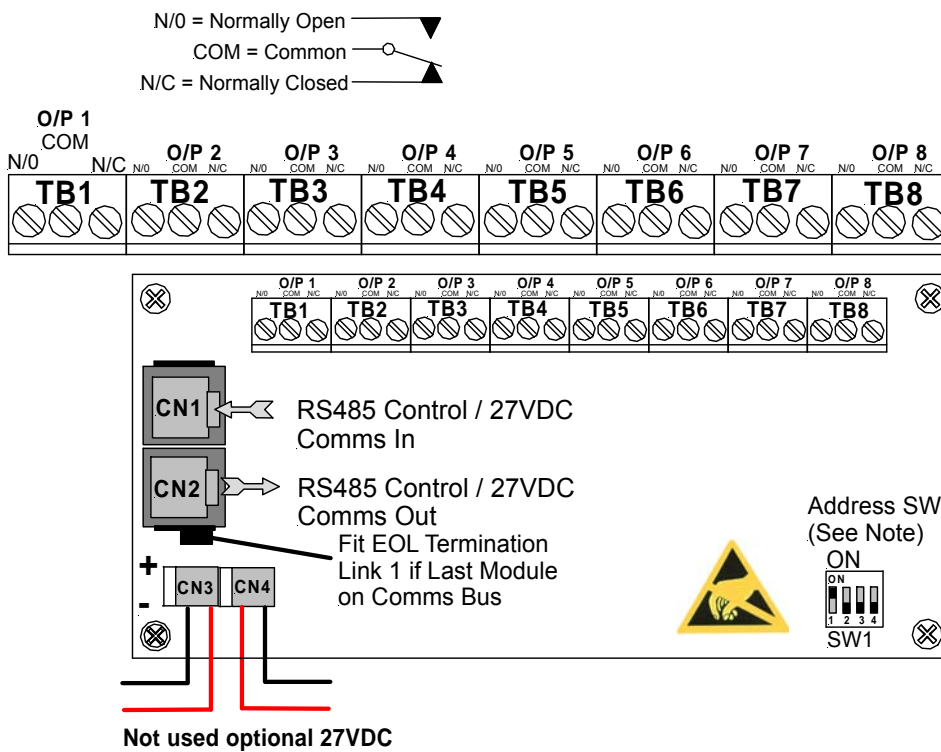

Figure 90: Internal 8 Way Relay Board Front View showing connectors and Address Switch

#### Relay Connections

Terminal/s	Function
TB1 to 8	N/O = Normally Open, C = Common N/C = Normally Closed
	Relay 1 to 8

**Note:** See Section 18 for Addressing Details (SW1)

### 12.8.2 Remote Relay Board

In the remote version the Comms In and Out Terminal Block TB9 is cabled to the RS485 Comms terminal block TB1 on the Communications Extender Board (see section 5.12) and can be installed up to 1.2kms from the FACP.

**Note:** Can be powered from the panel or an external 27 volt source.

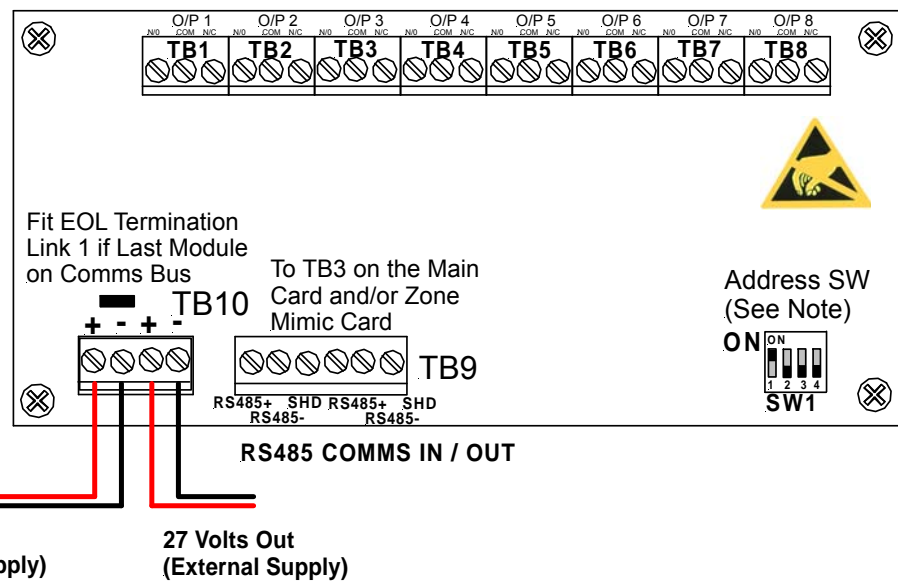
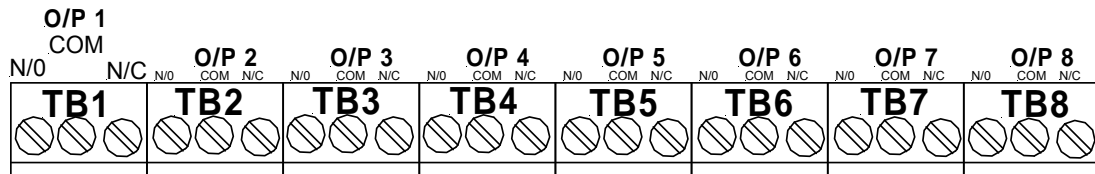
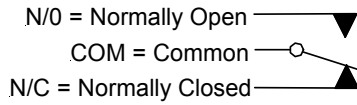

Figure 91: Remote 8 Way Relay Board Front View showing connectors and Address Switch

#### Relay Connections

Terminal/s	Function	
TB1 to 8	N/O = Normally Open, C = Common N/C = Normally Closed	Relay 1 to 8

#### Communications Connections

Terminal	Function	
TB9	RS485+ RS485- Shield	Communications In
TB9	RS485+ RS485- Shield	Communications Out

**Note:** See Section 18 for Addressing Details (SW1)



### 12.9 8 Way Sounder Board

The Sounder Board (BRD25SOP) expands the number of sounders that can be used on an FACP by 8. Each output is of a solid state design, rated at 24VDC / 750mA and requires a 10KΩ End of Line (EOL) resistor regardless of whether or not a sounder is wired to the circuit.

The sounder board will switch ON the sounders as configured (output off, continuous or pulsed) at the FACP and supervise the sounders for their open circuit, short circuit & line fault conditions.

**Note:** Sounder polarity MUST be observed.

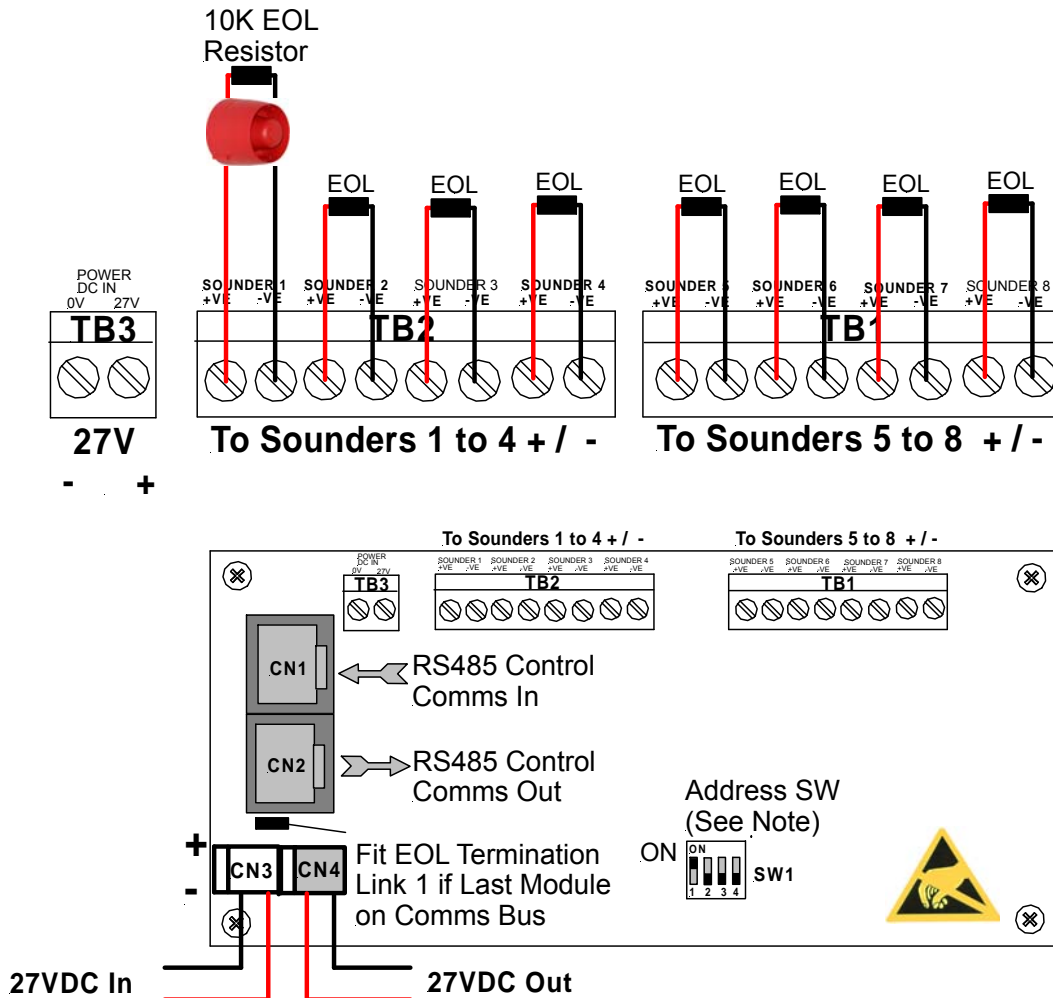

Figure 92: 8 Way Sounder Board Front View showing connectors and Address Switch

Maximum Current per Output: 750mA.

A +27VDC external power supply feed is required

In addition filtering and protection devices are used to reject transients.

**Connections**

Terminal/s	Function	
TB1 to 2	+ve -ve	Sounder 1 to 8
TB3	0V 27V	Power DC IN

**Note:** See Section 18 for Addressing Details (SW1)

### 12.10 4 Way Fire Fan Module

The Fire Fan Module (BRD25FCB) has four (4) separate fan controls each having an On, Auto and Off function switch and a set of three (3) monitoring LED's. The LED's indicate the status of the equipment e.g. Run, Fault or Stop. The two (2) arrow head buttons are used to step up and / or down through the three (3) conditions. A slip in label can also be inserted into the hinged cover for identification purposes.

The "Plant Trip" Reset is used to locally restart plant and equipment that has been automatically shut down because the FACP has initiated an alarm once that alarm has been cleared.

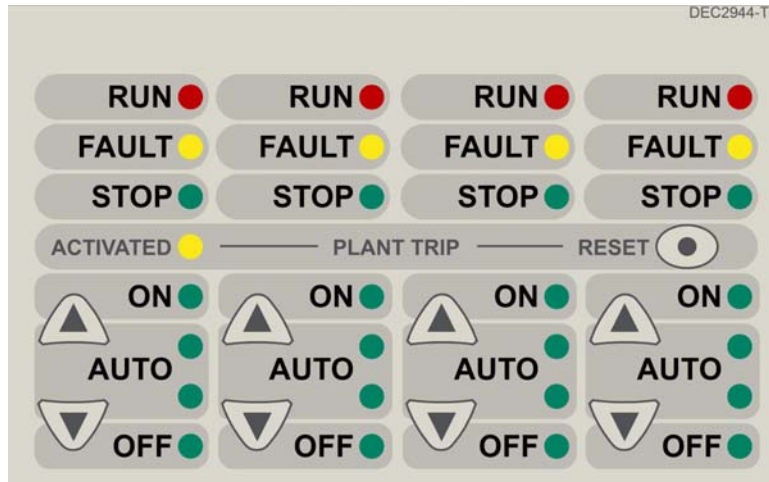

Figure 93: DEC2944-T1 4 Way Fire Fan Module (Slip in label fitted see LAB1486.doc)

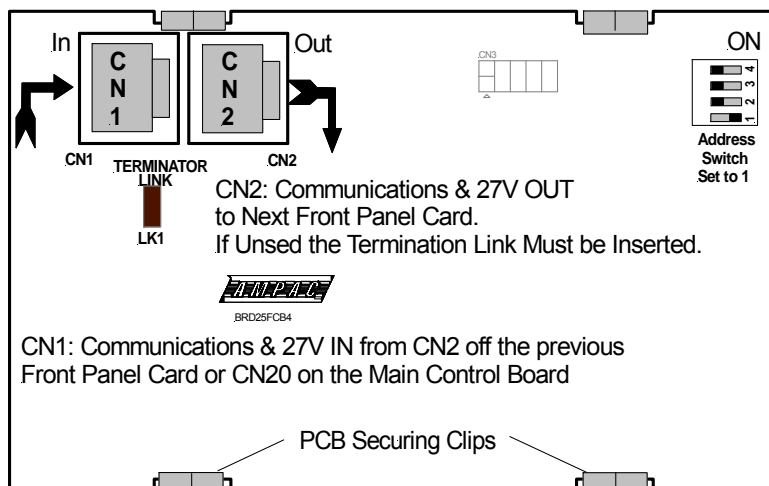

Figure 94: 4 Way Fire Fan Module Rear View showing connectors and Address Switch

**Note:** See Section 18 for Addressing Details (SW1)

### 12.11 4 Way Fan Termination Board

The Fan Termination Board (BRD25FTB) interfaces between the Fire Fan Module and the plant/equipment it controls via the 24 volt 250mA Start, Stop, current limited, relay outputs and monitor inputs. Programmable monitoring of the field equipment is achieved using 0 volts as an input level to indicate run, fault and stop conditions of that equipment. Monitoring is programmed in the Function Menu for a 3, 4 or 5 Wire Start / Stop, Run, Fault, Stop & Common functions. The inputs are protected by way of resettable transorbs and resistive / capacitive networks.

#### Connections

Terminals	Function	
TB2 to TB5	Start Stop Run FLT Stop Com	FANS 1 to 4

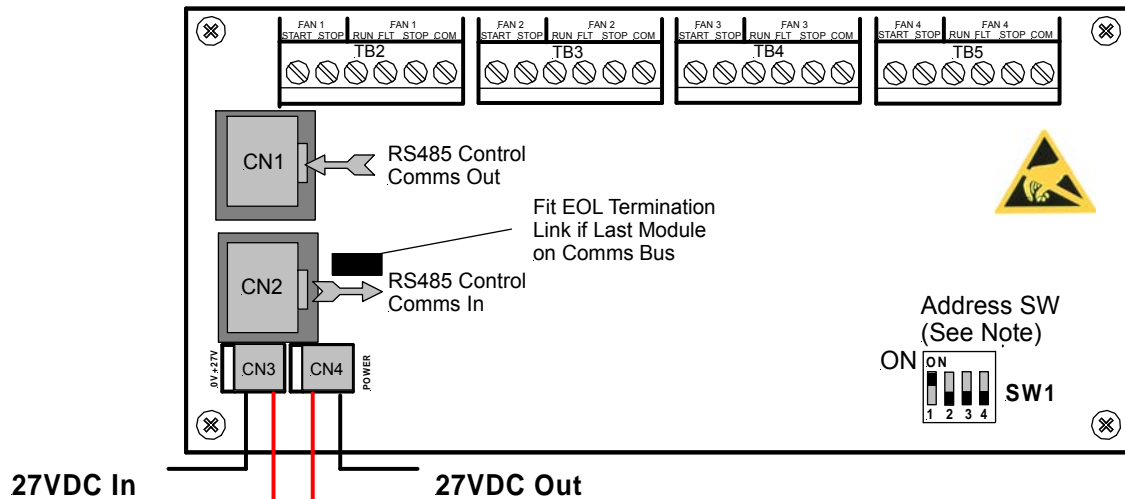
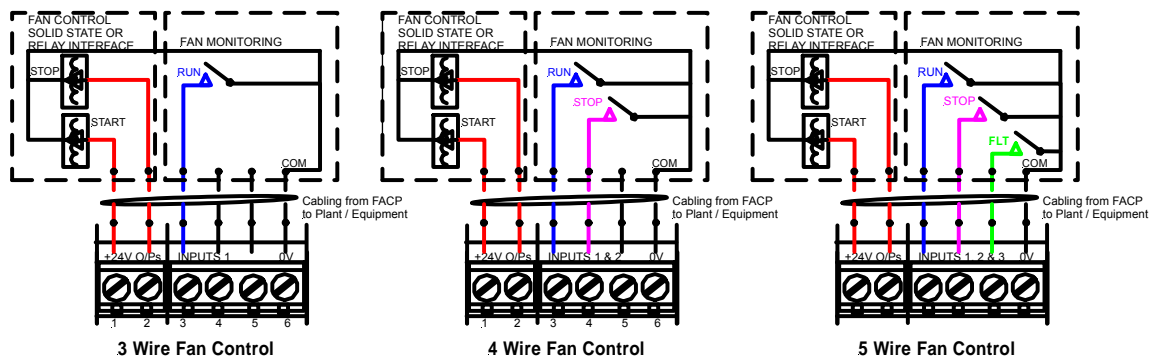

Figure 95: Fan Termination Board Layout and Typical I/O Wiring

**Note:** See Section 18 for Addressing Details (SW1)

### 12.12 Bargraph Display Card

The Bargraph display card (BDC) provides a smoke obscuration bargraph, alarm indicators, a reset and disable facility for a Pro-Sens fitted with an Ampac version of an APID fitted.

The BDC supports two detectors, which can be located in the same Pro-Sens unit or separate Pro-Sens units.

#### 12.12.1 Mechanical

The BDC is an Add On, so can be mounted locally into a standard FACP into the cabinet door cut out (as per SP1X, SP8X etc) or remotely using an enclosure

#### 12.12.2 Front Panel Decal

The following is the propose decal for the BDC

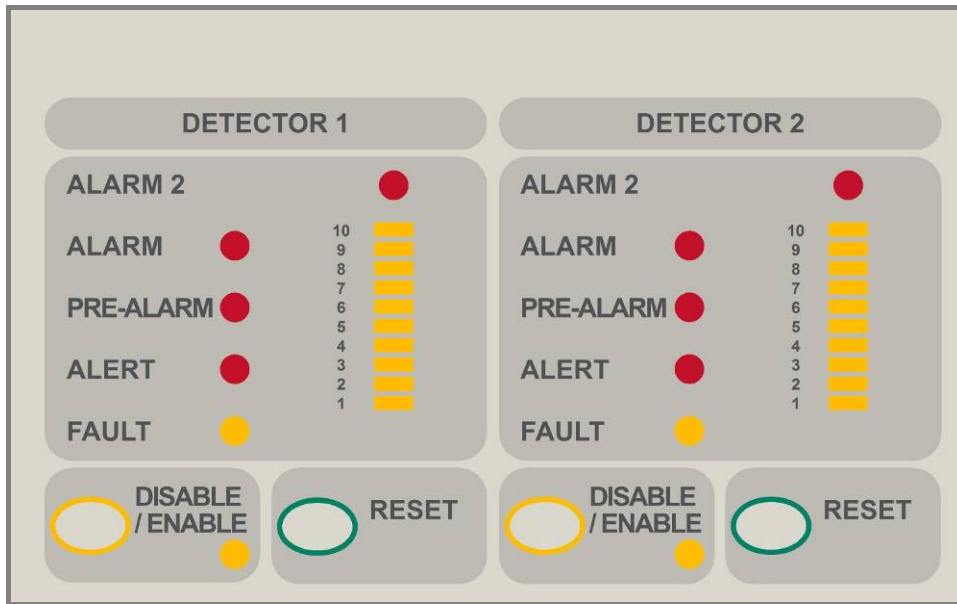

Figure 96: Bargraph Display Card Decal

#### 12.12.3 Front Panel Controls

##### RESET

This control is used to send a reset command to the linked (configured) APID device.

**Note:** This control does not reset the FACP.

##### DISABLE/ENABLE

This control is used to disable / enable the linked (configured) APID device.

**Note:** This control can't be invoked if the system's sounders (Alarm Devices) have not been silenced by means of FACP's ALARMS SILENCE/RESOUND key.

### 12.13 Occupant Warning Systems

The OWS system is intended to broadcast information (voice announcements for emergency purposes, alert signals, evacuate signals, visual and tactile warning devices) to provide warning to the occupants within one or more specified areas in an emergency, to effect a rapid and orderly mobilisation of occupants in an indoor or outdoor area.

Below are some of the features the OWS contains. For detailed specifications and functional information refer to MAN3072 OWS Technical Manual.

#### 12.13.1 Amplifier Board (25W and 50W)

The Amplifier features 4 digital inputs, 3 relay outputs (1A), a strobe output and a 100V line output.

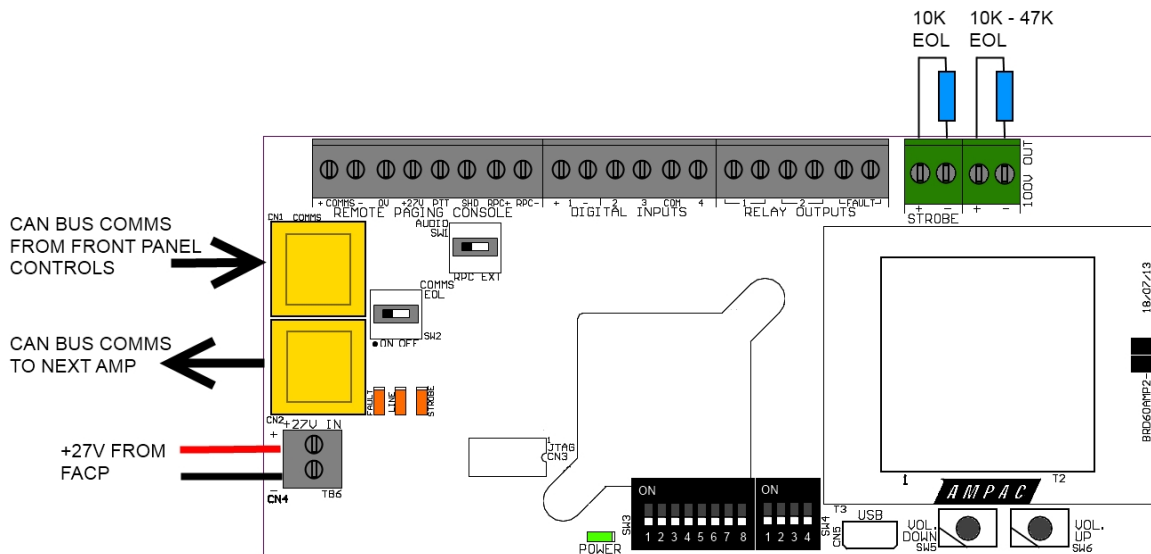

Figure 97: Amplifier Board

The Digital input functions are as follows:

<b>Input 1(+/-)</b>	Bell Input (FIB)	Active high input. Tie to 24V to activate (non-latching); 10kΩ load opens on fault; (Connect to FireFinder and ZoneSense Plus FACP's Warning System Output)
<b>Input 2</b>	Reset or Evacuate (Default = Reset)	Active low input. Short to 0V to activate (non-latching).
<b>Input 3</b>	Silence or Alert (Default = Silence)	Active low input. Short to 0V to activate (non-latching).
<b>Input 4</b>	External Fault or Custom Tone 400/450Hz @ 0.5Hz (Default = External fault input)	Active low input. Short to 0V to activate (non-latching).



**Note:** The digital inputs are not necessary when using the Front Panel Switch & Indicator board in the FireFinder Plus.

The Relays are rated to 1A and function as follows:

<b>Relay 1</b>	Emergency Warning Condition	Emergency: Relay Closed (energised) Quiescent: Relay Open (de-energised) No Power: Relay Open (de-energised)
<b>Relay 2</b>	Test Mode	Disabled: Relay Closed (energised) Enabled: Relay Open (de-energised) No Power: Relay Open (de-energised)

<b>Relay 3</b>	Fault Relay	Fault: Relay Closed (energised) No Fault: Relay Open (de-energised) No Power: Relay Open (de-energised)
----------------	-------------	---

The Strobe Output functions as follows:

<b>Strobe</b>	Provides a Bi-polar output for driving Visual Warning Devices. The output is monitored and requires 10kΩ 5% 1/3Watt EOL. Allows for 8 x Ampac Xenon Strobes (208-0011) or 40 x Ampac LED strobes 4107-1005/6)
---------------	---

The 100V line Output functions as follows:

<b>100V Out</b>	Provides an isolated 100VAC Audio Output. Supports up to 3 branches. The output is monitored. EOL value is 47kΩ 5% 1/3 Watt. For 2 branches use 100kΩ 5% ¼ Watt on each branch, and for 3 branches use 150kΩ 5% ¼ Watt on each branch.
-----------------	---

### 12.14 Communications Extender Board

The Communications Extender Board (BRD82LTB-C) is mounted inside the FACP and provides protected RS485 communications and 27VDC to the **SmartTerminal** Termination Board/s and LCD/s and LED Mimics.

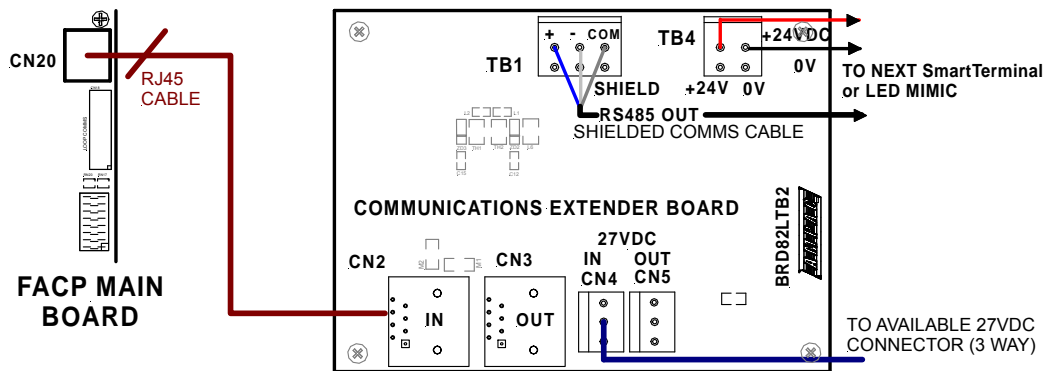

Figure 98: Communications Extender Board PCB Layout

## 12.15 SmartTerminal

**SmartTerminal** connects to the **FireFinder Plus** Fire Alarm Control Panel (FACP) via the RS485 Communications Extender Board. Generally it is designed to be used anywhere where the status of the FACP is required to be monitored by local personnel and limited control is required.

**SmartTerminal** has been designed for use with the **FireFinder PLUS** series of FACP's.

- 4 line by 40 character LCD with backlight and navigation buttons ▲ ▼ buttons allow the SmartTerminal to be used for FACP operation and interrogation. Note the backlight is only energised when alarms are present, a key has been pressed or controls enable key switch is enabled
- Buzzer and system Reset.
- System expansion capabilities / options:
- A wide range of secure user functions. This includes the ability to disable / re-enable a large number of system functions.
- Flush or surface mountable enclosure.
- Controls have tactile and audible feedback of operation.
- All terminals cater for 2.5mm cables.

### 12.15.1 Overview

**SmartTerminal** consists of two PCBs;

1. SmartTerminal Termination Board. A Termination Board is mounted in each SmartTerminal to protect and interface the RS485 communications and 27VDC supply to the LCD Board
2. BRD82ZICC – Control, LCD Communications and LCD Driver Board

 **Note:** A maximum of 30 **SmartTerminal's** may be connected to the communications bus over a distance of approximately 1.2Kms

12.15.2 Mechanical

**SmartTerminal** is supplied in an ABS cabinet and consists of;

The Main Card, with all controls and indicators mounted directly onto it

- 1 X Termination Board
- 2 X ABS door keys
- 2 X 003 Enable / Disable keys
- 2 X Jumper links
- 2A Power Supply only if internally powered

The front door of the ABS version is locked by way of two clips on the right hand side of the cabinet. A special locating key which has two raised pins that are inserted into the side of the cabinet unlocks the door.

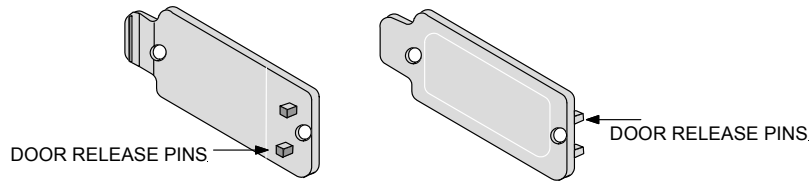

Figure 99: ABS Door Key and Front Panel Add On Card Surround Release Clip

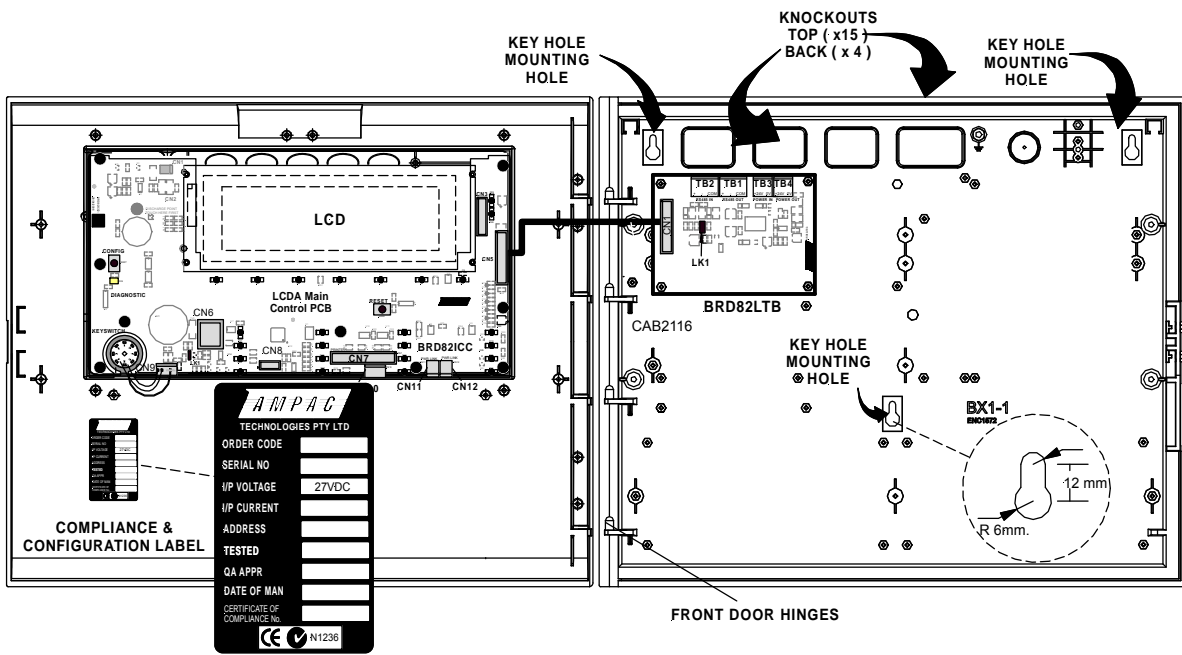

Figure 100: Typical Layout (Externally Powered) and Location of Keyholes



### 12.15.3 Installation & Cabling

*SmartTerminal* is connected to the FACP as shown below.

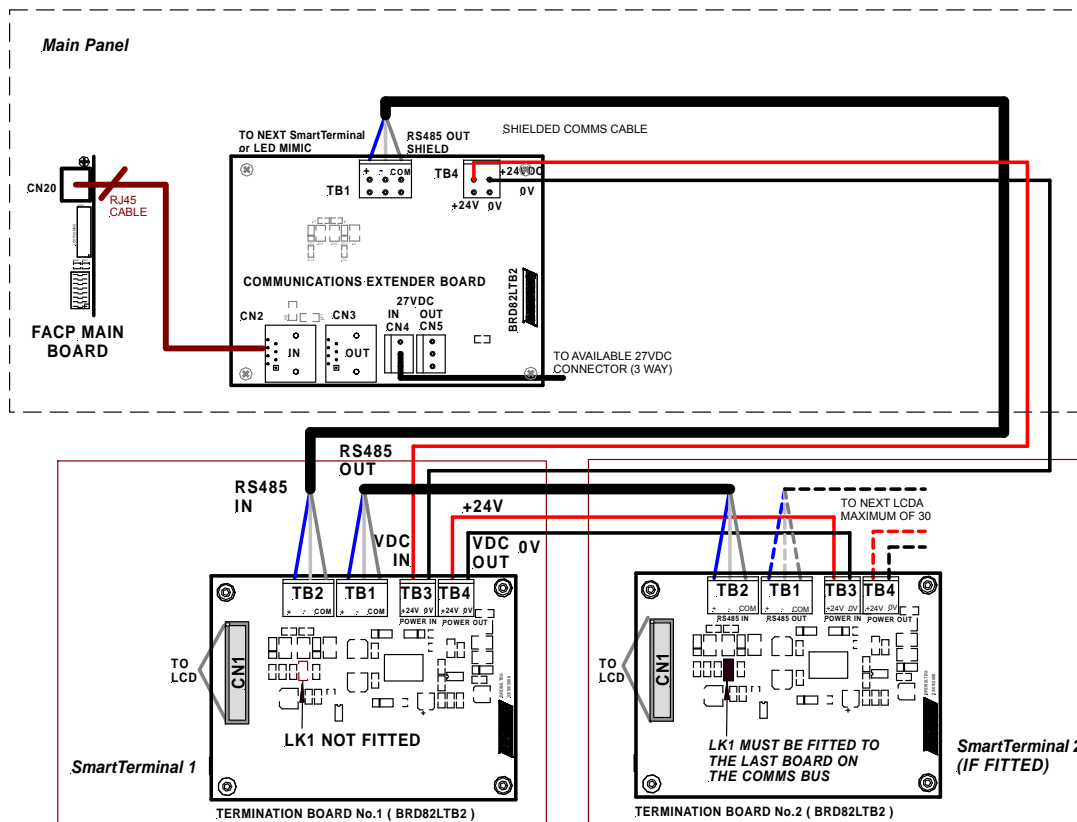

Figure 101: Connecting *SmartTerminal*'s to the FACP

### 12.15.4 Setting the *SmartTerminal* Address

Open the front door; locate the “CONFIG” button situated on the left hand side of the PCB and press for 3 seconds. The buzzer and “Config” LED will double beep and flash respectively to indicate that the Configuration mode has been entered. The LCD will now display the Configuration screen. This screen consists of the code version number, current address and four adjustment markers. These markers A-, A+, C-, and C+ are used to indicate the buttons that adjust the address and LCD contrast.

Use the “PREVIOUS (A-) and NEXT” (A+) buttons to select the desired address. The default value for this address is 255 which is not a valid *SmartTerminal* address. The user must then select an address value from 1 to 30, i.e. the same address as that set in the FACP. The buttons corresponding to C- (SILENCE BUZZER) and C+ (RESET) are used in a similar manner to decrease and increase the LCD contrast level. There is audible feedback for all button presses.

Once the address has been set press the “CONFIG” button again for 3 seconds and the screen will return to its default and the “DIAGNOSTIC” LED will return to a slow flash. This slow flash indicates *SmartTerminal* and the FACP are communicating normally i.e. the LED flashes if communications data is being received from the FACP.

**Note:** If the address is not set within the time out period of approximately 75 seconds *SmartTerminal* will return to its previous state.

### 12.15.5 Operation

The operation of **SmartTerminal** can be considered to be in one of three states, these are;

1. Power up - when the **SmartTerminal** is initialising
2. Normal - when the **SmartTerminal** address has been set and is communicating with the FACP, reporting normal / abnormal conditions and controlling the FACP via the front panel controls
3. Fault where the **SmartTerminal** is in fault and/or is unable to communicate with the FACP.

#### Power Up

The LCD displays a message telling the operator **SmartTerminal** is being powered up and that the hardware is being initialized. Once the hardware has been successfully initialized set the address and **SmartTerminal** should automatically transition to the normal state. Should a failure occur on power up press the “RESET” button located on the LCD PCB and check the address is correct.

#### Normal

The Normal state is entered from the “Power-up” or a return from the “Fault” state and is displayed on the LCD if the **SmartTerminal** is communicating with the FACP and operating correctly. In this state the front panel Power indicator is illuminated.

#### Fault

**SmartTerminal** enters the Fault state upon;

- A hardware failure
- LCD module failure or
- A loss of communications with the FACP (indicated by the “DIAGNOSTIC” LED – not flashing and the “no communications “ message being displayed)

In a Fault condition the front panel NORMAL indicator is extinguished and the details of the fault are displayed on the LCD. The FACP will also indicate a fault in a similar manner.

#### Access levels

There are two levels of access.

**Access level 1** only the silence buzzer, previous, next and override front panel controls are operative. All other controls operate in access level 2.

**Access level 2** is entered when the key-switch is in the ENABLED position.

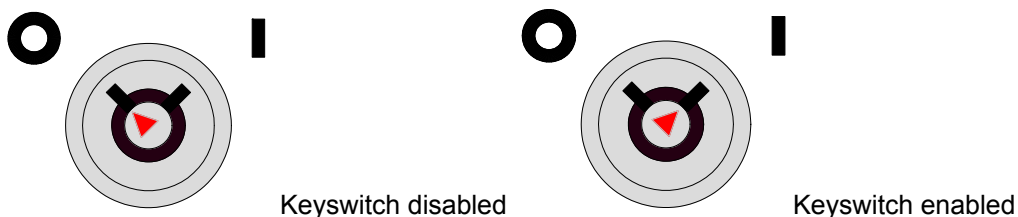

Figure 102: Keyswitch showing Disabled / Enabled Positions

12.15.6 **SmartTerminal Controls and Indicators**

All controls, except for the controls Enable / Disable Keyswitch, are of a momentary push button style and operate in exactly the same way as does the FACP itself.

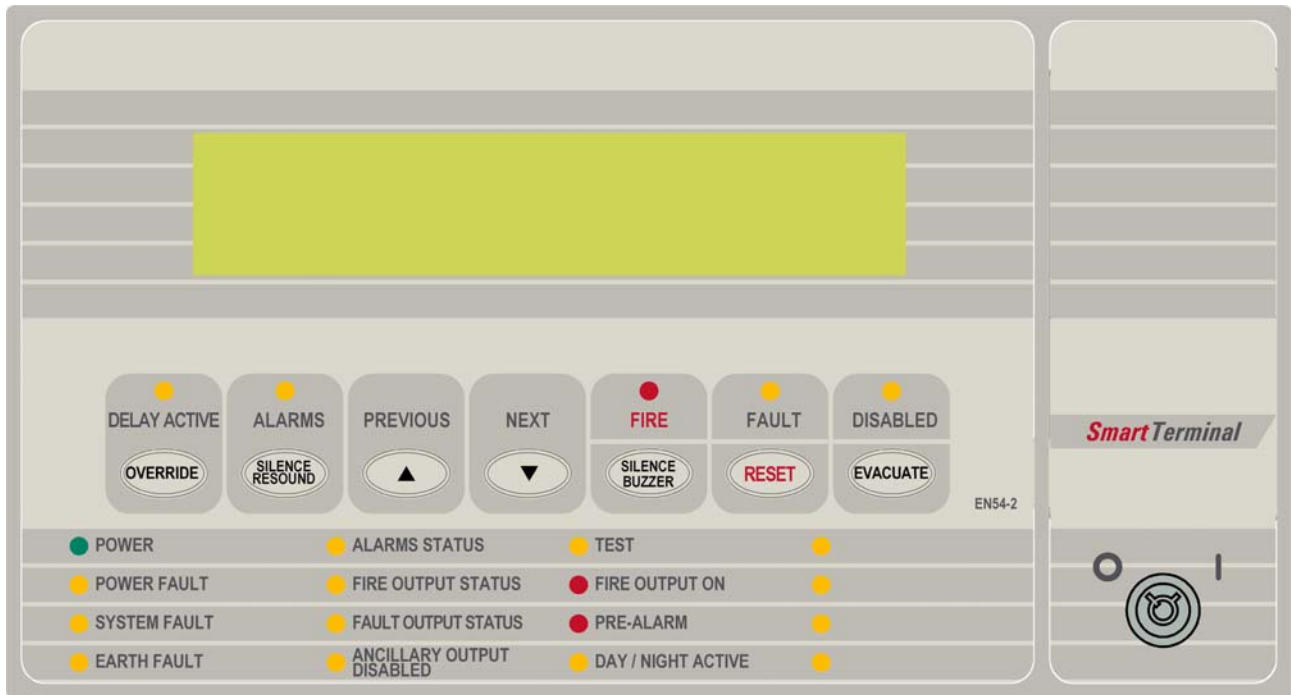

Figure 103: **SmartTerminal** Front Panel Layout

12.15.7 **SmartTerminal Screen Format**

There are 3 events that can be reported and displayed by **SmartTerminal**. The types of event are;

- Fire
- Faults and
- Disables.

The types of events are only associated with devices and detectors hence faults associated with modules, loops O/C – S/C, power supplies and so forth are not reported on the LCD.

The **SmartTerminal** has front panel indicators for each type of event. When **SmartTerminal** is configured not to report a type of event and that event type is present (and the corresponding front panel indicator is illuminated on the **SmartTerminal**), then a standard information screen is displayed on the LCD stating the system is not normal and the operator should see the FACP.

**Alarm:** If configured the screen format for reporting loop / device / zone fire condition is:

```

<point location>      FIRE
<point descriptor>   <type>
<date> <time>
FIRE XXX OF XXX
```

**Fault:** If configured the screen format for reporting loop / device / zone fault condition is:

```

<point location>      FAULT
<point descriptor>   <type>
<date> <time>
FIRE XXX OF XXX
```

**Note:** The fault types only relate to devices.

In the event of a loss of communications, for a period of greater than 15 seconds the **SmartTerminal** will default to the No Communications screen. The format for this screen is:

```
No Communication
```

**Device Isolate / Disables:** If configured the screen format for reporting loop / device / zone disable condition is:

```
<point location>      DISABLED
<point descriptor>    <type>
<date> <time>
FIRE XXX OF XXX
```

**Pre-alarm:** If configured the screen format for reporting loop / device / zone Pre-alarm condition is:

```
<point location>      PRE-ALARM
<point descriptor>    <type>
<date> <time>
PRE-ALARM   XXX OF XXX
```

**Normal / Default:** The format for reporting that everything is normal is:

```
<DATE> <TIME>

<SYSTEM STATUS>
```

The default screen is only displayed when there are no device alarms, device faults or device disables present on the system.

The highest priority current system status will be displayed and can be one of the following listed in order of highest to lowest priority:

- “SYSTEM ALARM”
- “SYSTEM PRE-ALARM”
- “SYSTEM FAULT”
- “SYSTEM ISOLATE”
- “SYSTEM NORMAL”

**Config:** The Config screen displays the following.

```
VX.X (software version number
Address

A- A+ C- C+
```

A - , A + : adjusts the address 1 to 30, 30 being the maximum number of **SmartTerminal's** that can be connected to the FACP, ( default is 255 which is not a valid address).

The function buttons perform the following;

- A – Press “Previous”                      A+ press “Next”
- C - C+: decreases [-] and increases [+] the LCD contrast level.

The function buttons perform the following;

- C – Press “Silence Buzzer”                      C+ press “Reset”

## 12.16 Printer

### Specifications

- Printing method: directed impact dot matrix
- Interface: 8 bit parallel interface
- Printing mechanism: 4/6 pin shuttle
- Interface port: 26 PIN flat plug

### 12.16.1 Indicators and Buttons

The front panel has an LED indicator and two buttons SEL (SELECT), LF (LINE FEED).

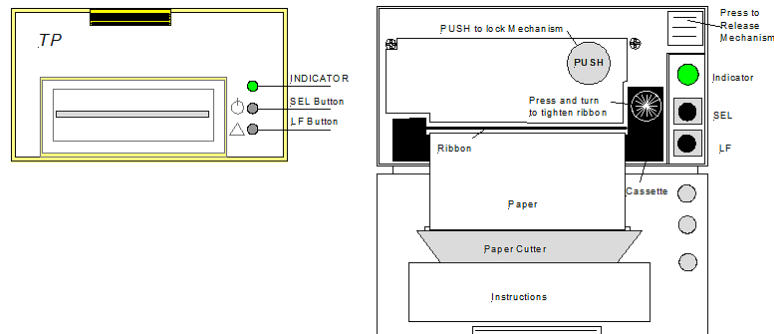

Figure 104: Printer Front Panel Layout (Front Cover Closed / Open)

#### Indicator

When the 3 colour LED indicator is illuminated;

- Red indicates the printer is offline with no paper;
- Green indicates the printer is On Line;
- Yellow indicates the printer is On Line with no paper; or if it is
- Off indicates the printer is Off Line or the printer is busy.

#### SEL Button

##### a) On Line / Off Line State

The printer enters the On Line state automatically when power is applied or on exiting from the Self-Test mode. (LED is green).

Press the SEL button, the LED is turned off and the printer goes Off Line.

Press the SEL button again, the LED turns on and the printer is On Line again.



**Note:** The printer will not receipt data when the printer is off line.

##### b) Pausing the Printer While It Is Printing.

Press the SEL button while the printer is printing, the printer will pause and enter the Off Line mode after it finishes printing the row it was currently printing. The printer will continue to print when the SEL button is pressed again.

##### c) Enter the HEX-DUMP mode

Remove power from the printer, press the SEL button, then reconnect the printer to the power supply. The printer will enter the HEX-DUMP mode. In this mode any programs sent from the host CPU will be printed out in Hexadecimal.

#### LF Button

While the printer is Off Line press and hold the LF button, paper feed will be initiated. Release the LF button and the paper feed will be cancelled.

**Self-Test Mode**

With power applied (green LED illuminated) push the SEL button. This will turn off the LED. Press and hold in the LF button, then press the SEL button again and the printer will enter the Self Test mode. Self-test will print out all the valid characters in the character sets.

**Exit the Self-Test Mode:**

After printing out the complete Self-Test list the printer will exit the mode automatically; or Press the SEL button and the printer will immediately exit the Self-Test mode.

**12.16.2 Maintenance**

**Installing the Ribbon Cassette**

The printer has a factory loaded ink ribbon cassette. Remove the power from the printer.

Unlock the front cover by pushing down on the tab at the top of the front panel.

Push the mechanism release button in the top right corner to release the print head.

To remove the ribbon cassette gently pull out the left end then the right.

Replace the cassette by putting the right end of the new cassette slightly onto the drive axle then gentle pushing the left end into the clips.

The left end of the cassette can only be pressed in after the right end has been correctly seated onto the drive axle. If alignment is difficult it may be necessary to turn the knob on the cassette slightly. Now check that the ribbon is tight across the face of the cassette, which is on the inside of the cassette and across the paper. Turn the knob clockwise again if the ribbon is on the outside of the cassette.

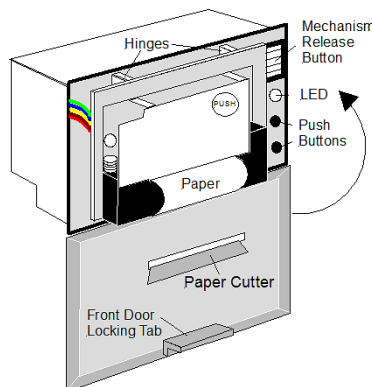

Figure 105: Paper Access

**Ribbon Replacement;**

Push back the mechanism head and lock it, close the cover of the printer and reconnect the power.

**Loading the Paper Roll**

Disconnect the power, unlock and open the front cover.

Push down on the mechanism release button in the top right corner to release the head.

Lift the mechanism as shown below.

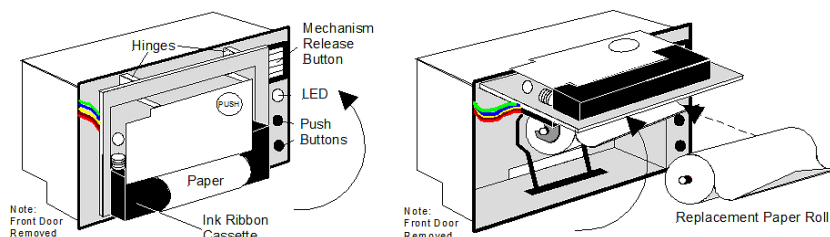

Figure 106: Head Mechanism Rotation and Paper Roll Removal / Insertion

Take out the empty paper roll and roller

Put the new paper roll onto the paper roller and replace as shown above.

Connect to the power supply.

Press the SEL button to take the printer Off Line, (LED is off).

Press the LF button, (paper feed).

Feed the edge of the paper into the mechanism and allow it to feed through.

Once it established the paper is feeding through the head mechanism correctly press the SEL button to stop the paper feed.

Return the printer head to its original position.

Pushing on the affixed label PUSH the head mechanism back into position.

Close the front cover.



**Note:** Press only on the **PUSH** label to return the head mechanism back into position.



**Note:** The above instructions are graphically displayed on the inside of the front cover.

### 12.16.3 Printer Connections and Jumpering

Mounted on the back of the printer mechanism is the PCB that carries the;

- Connectors for interconnection to the Main Board,
- Jumper links required to set the programmed print modes; and
- Printer 5 volt DC Power Supply.

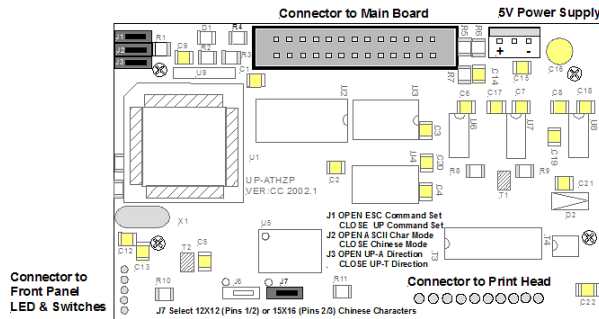

Figure 107: PCB Layout

#### Jumper Settings

Designator	Jumper State	Function
<b>J1</b>	NOT Inserted	Selects ESC Commands
	Inserted	Selects UP Commands
<b>J2</b> Set as Default	NOT Inserted	Selects ASCII Character Printing Mode
	Inserted	Selects Chinese Character Printing Mode
<b>J3</b>	NOT Inserted	Select Printing by Contrary Direction
	Inserted	Select printing in the Normal Direction
<b>J7</b> Set as Default	Insert the Shorting Clip Between Pins 1 and 2	Selects the 12 X 12 Font
	Insert the Shorting Clip Between Pin 2 and 3	Selects the 15 X 16 Font

### 12.16.4 Printer 5 Volt Power Supply

27 volts DC is taken from Main Board (BRD86MBA) and fed to CN1 of the 5volt Printer Power Supply Board (BRD42PVCB). It is this board that drops this voltage from 27volts to 5volts for use by the Printer. Mounted to rear of printer

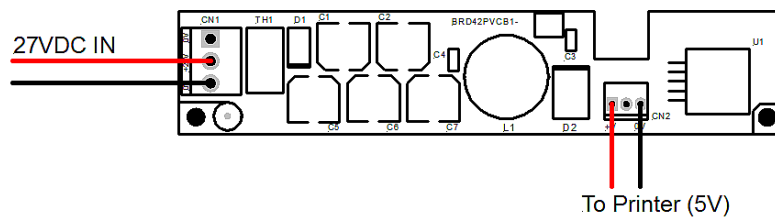

Figure 108: Printer Power Supply Board Layout



## 12.17 Agent Release Control

Agent Release control consists of an Agent Release Module, Termination Board and an optional Local Control Station.

### 12.17.1 Operation

#### Introduction

The Agent Release Module and Termination Board communicate with the FACP via the RS485 multi-drop bus.

The Local Control Station communicates only with the Termination Board via a separate RS485 bus. Up to 4 Local Control Stations can be connected to one termination board.

Agent discharge operates in two modes – automatic and manual. The manual mode is selected by pressing the Inhibit switch on any Local Control Station. To indicate the system is in manual the Inhibit LED will be illuminated. Pressing Inhibit again will toggle or return the mode to automatic and extinguish the Inhibit LED.

The “Agent Released” Pressure Switch (PSW) is wired to the PSW input on the Termination Board and is used to confirm that the agent has been released. The circuitry involved in this process can be configured to accept a normally open contact, normally closed contact, normally open mechanically operated (manual) or is ignored (not fitted) and is selected via FACP on-site programming. If the mechanical (manually operated) option is selected the module monitors the pressure switch input and provides notification the agent has been released manually, initiates an alarm and illuminates the “Agent Released “ indicator.

#### Manual Mode

When the system is in manual mode, then;

- The Local Control Station Inhibit indicator is lit at the FACP and all Local Control Station's.
- The buzzer at all Local Control Stations will sound until the inhibit button is released.
- The System Inoperative output is turned on.
- The Automatic discharge sequences are prevented from starting.
- If an automatic discharge sequence was underway and the inhibit switch is activated (switched to manual mode) the discharge sequence is aborted and the sequence is reset. This means the Stage 1 and Stage 2 outputs are switched off.

To manually discharge the agent the “ Lock Off Valve “ must be open and the Manual Release switch on the Local Control Station pressed. The manual discharge sequence is;

- Manual Activation indicator is lit on the FACP and Local Control Station.
- The FACP activates its brigade alarm output.
- Stage 1 outputs are switched to +24VDC. (FIRE ALARM sign illuminated, aural alarm sounds)
- Stage 2 outputs are switched to +24VDC. (FIRE ALARM, EVACUATE & DO NOT ENTER signs illuminated, aural alarm sounds).
- The optional pre-release start delay is activated (Selected via FACP on-site programming); time out and an ON Interlock signal will then operate the selected release circuitry.
- The Agent Discharge LED on the Agent Release Module and Local Control Station will illuminate when the Pressure Switch input on the Termination Board is activated.
- Activate gas-fired output.



**Note:** The Interlock Input can be defaulted to the on position by placing a 10K $\Omega$  EOL termination resistor across the terminals TB2. 7 / 8 of the Agent Release Module and Local Control Station.

#### Auto Mode

Automatic discharge is when one or two zones going into alarm initiate the agent discharge sequence.

 **Note:** A “manual release” can still be initiated in “auto mode” but the LCS “Inhibit” control **WILL NOT** inhibit / abort the agent release sequence.

**Single Zone Activation**, the following discharge sequence is executed;

- Automatic Activation LED is illuminated on the Agent Release Module and Local Control Station.
- Stage 1 outputs are switched to +24VDC. (FIRE ALARM sign illuminated, aural alarm sounds).
- Stage 2 outputs are switched to +24VDC. (FIRE ALARM, EVACUATE & DO NOT ENTER signs illuminated, aural alarm sounds).
- Optional pre-release delay is started (Selected via FACP on-site programming).
- The delay times out and if the Interlock signal is ON, the selected circuit will activate.
- The Pressure Switch field input on the Termination Board is activated and the Agent Discharge LED on the Agent Release Module and Local Control Station will be illuminated.
- Activate gas-fired output.

**Dual Zone Activation**, if the first zone goes into alarm the following steps are initiated;

- The automatic activation LED on the Agent Release Module and Local Control Station will flash.
- Stage 1 outputs are switch to -24VDC. [FIRE ALARM sign illuminated, aural alarm sounds].

When the second zone goes into alarm, then the following steps occur;

- Automatic activation LED goes steady.
- Stage 1 outputs are switched to +24VDC. (FIRE ALARM & EVACUATE signs illuminated, aural alarm sounds)
- Stage 2 outputs are switched to +24VDC. (DO NOT ENTER sign illuminated)
- Optional pre-release delay commences (Selected via FACP on-site programming).
- The delay times out and if the Interlock signal is on the selected circuit will activate.
- The Pressure Switch field input on the Termination Board is activated and the Agent discharge LED on the Agent Release Module and Local Control Station will be illuminated.
- Activate gas-fired relay output.

### Service Switch

The service switch is situated on the Agent Release Module when activated causes the following;

- Electrically isolates the activation circuitry from the agent release device.
- Operates the System Inoperative output.

 **Note:** The service switch is **NOT** overridden by a manual discharge.

### Lock-Off Valve





When the manual lock-off valve is operated;

- The agent is blocked from reaching the release valve.
- The lock-off valve inhibit indicator LED's on the Agent Release Module and Local Control Station are illuminated.
- The system inoperative output operates.

### Fault Monitoring

Fault conditions are initiated by:

- The Pressure Switch monitoring circuit.
- The Low Pressure Switch monitoring circuit.
- The Lock-off Valve monitoring circuit.
- Activation circuitry.
- Stage 1 outputs. (Aural & visual discharge alarms).
- Stage 2 outputs. (Aural & visual discharge alarms).
- A Zone Fault.
- A Fault on the interlock input.
- A Fault with a LCS.

-  **Note #1:** The common fault indicator on the Agent Release Module and Local Control Station is illuminated for any Fault condition.
-  **Note #2:** For a pressure switch fault, low pressure switch fault, lock-off valve fault, stage 1 output fault, stage 2 output fault and interlock fault, the FACP will signal the brigade.
-  **Note #3:** When there is a fault in the activation circuit or in the trigger zones, in addition to the above, the system inoperative output is operated.
-  **Note #4:** The FACP fault buzzer will sound for all faults.
-  **Note #5:** The FACP will report the type of fault on the LCD.

### Isolation

If a trigger zone is isolated at the FACP the trigger zone isolated indicator at the Agent Release Module and Local Control Station is illuminated, and the system inoperative output is operated.

### System Inoperative Output

The system inoperative output is switched to +24VDC under the following conditions;

- Operation of the Service Switch.
- A Fault in the selected trigger circuit.
- Operation of the Lock-off valve.
- Operation of the Inhibit at an Local Control Station.
- A Fault in any of the activation zones.
- If any of the activation zones are isolated.

### Manual Mechanical Release of the Agent

With agent release systems, a manual mechanical means can be provided to release the agent.

If the pressure switch is activated (indicating that the agent has been released), and the agent release module has not activated the selected activation circuit, then the following will occur:

- Stage 1 output is switched to +24VDC and stage 1 relay is output closed
- Stage 2 output is switched to +24VDC and stage 2 relay output is closed
- Light the agent release led on the ACC and LCS's
- Activate gas-fired relay output

### Monitoring of the Pressure Switch

Due to the requirements of Manual Mechanical Release of the Agent, the pressure switch input conveys two pieces of information:

When the pressure switch input is active, it signals that the agent has been released. The release can be as a result of the agent release module or due to a manual mechanical release.

When the pressure switch is not active, it signals that there is a full bottle of agent available to be discharged.

In order for the agent release module to respond to a manual mechanical release, the pressure switch must have been previously not active, to signify that a full bottle of agent is available

### 12.17.2 Agent Release Module

The Agent Release Module controls and monitors all the requirements for agent release.

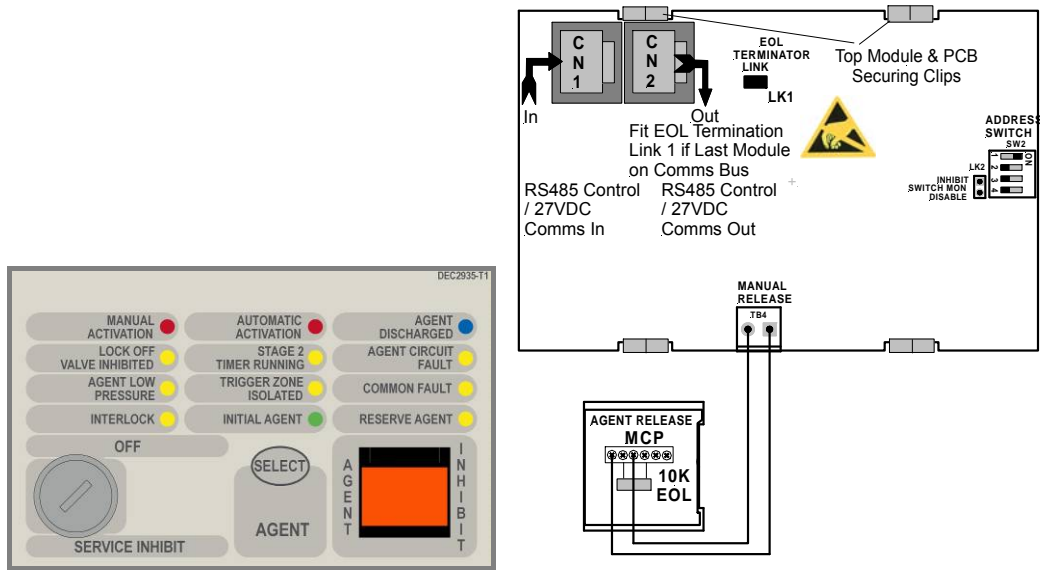

Figure 109: Exploded View of Module and Front Panel Layout

The PCB is fitted with two 2 x RJ45 connectors CN6 & 7 for power (27VDC) and communications (RS485) for communications between the Agent Release Module and the FACP Main Control Board.

#### Controlled Access



It is a requirement that control be secured from unauthorised use. A keyswitch has therefore been included in the control process.

The FCP goes into service mode when the keyswitch is switched to SERVICE INHIBIT. This results in the selected agent activation circuit being electrically isolated and a Common Isolate condition being indicated at the FACP. This condition can also be confirmed through the Status Menu. To remove the key it is necessary for the switch to be in the **OFF** position.



Pressing Select toggles the selection of either the Main or Reserve release agent. Selection is indicated by the Main and Reserve Agent LED's



Pressing the Agent Inhibit switch will inhibit the gas from release in either the Manual or Automatic mode. The Agent Inhibit switch has an internal lamp fitted with yellow lens and is illuminated when the Inhibit switch is activated at the FACP or any of the LCS's. To prevent accidental operation this switch has a hinged clear plastic cover that has to be raised to access the switch.

**12.17.3 Local Control Station**

The Local Control Station is supplied fitted into an IP40 rated enclosure and has the same indicators and Manual Release switch as the Agent Release Module within the Fire Alarm Control Panel (FACP) but no Agent Select button or Service Inhibit keyswitch.

The Comms line is RS485 and is cabled to the Agent Termination Board.

The Interlock is a monitored input with 10KΩ EOL. This input is used to determine if air conditioning dampers and doors are closed but can be defaulted to the “ON” condition by terminating the input with a 2K2Ω EOL.

Double action switching is achieved by way of protective lift up covers seen here and manual operation of the MCP or Inhibit switch. To ensure correct operation and prevent accidental release of the agent these covers **should not** be disabled for any reason



Figure 110: Local Control Station

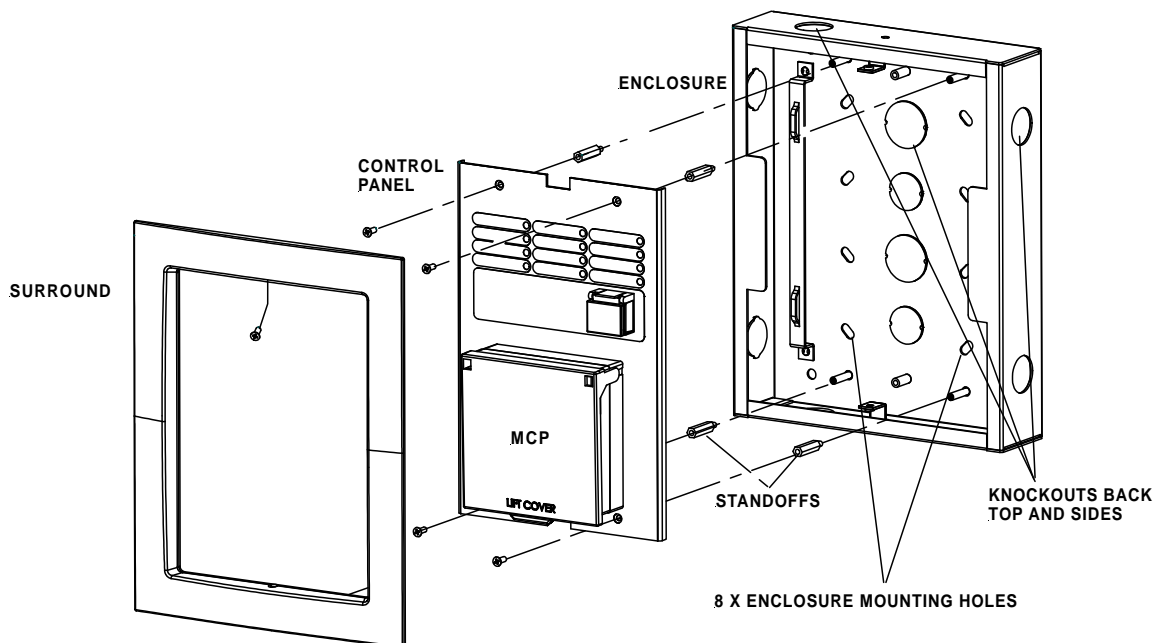

Figure 111: Local Control Station Layout

**LCS Operation & Controls**

Lifting the cover and pressing the MCP starts the manual agent release sequence. This two action safety feature prevents any accidental operation of the control and should not be disabled.

### Agent Release / LCS Indicators

There are 12 indicators on both the Agent Release Module and Local Control Station. They are;

**MANUAL ACTIVATION** 

**(Red)** Illuminated when a manual release sequence has commenced. A Manual release sequence can only be started by activating the manual release at the FACP or LCS. The indicator is extinguished by activating RESET on the FACP.

**MANUAL ACTIVATION** 

**(Red)** Illuminated when a manual release sequence has commenced. This occurs when the selected zone(s) on the FACP have gone into alarm. For dual zones, the indicator should flash when the first zone goes into alarm, and steady when the second zone goes into alarm. Indicator is extinguished by activating RESET on the FACP.

**AGENT DISCHARGED** 

**(Blue)** Illuminated when the pressure switch indicates the agent has been released. For Pyrogen, feedback is from the thermal switch. If there is no pressure switch fitted, the indicator shall be illuminated immediately the agent release signal is activated (Selected via FACP on-site programming – refer to relevant FACP Manual)

The indicator is extinguished by activating RESET on the FACP.

**LOCK OFF VALVE INHIBITED** 

**(Yellow)** Illuminated when the lock-off valve has been activated.

**STAGE 2 TIMER RUNNING** 

**(Yellow)** Illuminated when the pre-discharge delay timer is running. The indicator is extinguished by activating the RESET control on the FACP.

**AGENT CIRCUIT FAULT** 

**(Yellow)** Illuminated when there is a fault on the monitored Main or Reserve activation circuits e.g. S/C or O/C.

**AGENT LOW PRESSURE** 

**(Yellow)** Illuminated when the low pressure switch is activated. This indicates a leakage at the agent cylinder. The low pressure switch is a separate switch.

**TRIGGER ZONE ISOLATED** 

**(Yellow)** Illuminated when any of the programmed trigger zones on the FACP are isolated.

**COMMON FAULT** 

**(Yellow)** Illuminated under the following fault conditions;

- pressure switch monitoring fault,
- low pressure switch monitoring fault,
- lock-off valve monitoring fault,
- activation circuit fault,
- stage 1 output fault,
- stage 2 output fault,
- LCS fault (missing or extra),
- trigger zone(s) fault,
- low agent pressure and interlock fault.

**INTERLOCK** 

**(Yellow)** Illuminated when the interlock input (e.g. from dampers, doors etc) is off during the discharge sequence – meaning the dampers, doors etc are not closed as they should be or a fault exists. The “Interlock” is overridden after 10 seconds and the agent is released



**Note:** The Interlock is a Monitored Input and can be defaulted to the ON position by terminating the input (TB2 7 & 8) into a 2K2Ω resistor.

**INITIAL AGENT** 

**(Yellow)** Illuminated when the “Initial Agent” is selected.

RESERVE AGENT

(Yellow) Illuminated when the "Reserve Agent" is selected.

**Local Control Panel Inhibit**



The agent inhibit switch has an internal lamp fitted with yellow lens. Illuminated when the inhibit switch is activated at the FACP or any of the LCS's.

**Buzzer (located at the FACP)**

The Buzzer sounds;

- Under all fault conditions and can be silenced by using the appropriate FACP buzzer silence control.
- When the LCS Inhibit control is activated – after 8 hours – treated as an isolate condition.
- When the service inhibit is activated - after 8 hours – treated as an isolate condition

**Connecting the LCS to the Agent Termination Board**

1. ISOLATE THE AGENT
2. Check the FACP is functioning correctly then power down
3. Connect the LCS to the Agent Termination Board within the Fire Alarm Control Panel and Interlock as shown below. If applicable take into consideration warning signs at this point
4. Insert the link LK1 onto the last LCS in the chain. If un-used place the link onto one of the LK1 pins
5. Set the address of the LCS,
6. Power up the system and program the FACP for the addition of the LCS
7. Check the FACP is functioning correctly and test
8. De-isolate the Agent

**CAUTION** - TO PREVENT ACCIDENTAL AGENT RELEASE DO NOT DE-ISOLATE THE AGENT UNDER ANY CIRCUMSTANCES UNTIL THE SYSTEM AS A WHOLE IS FUNCTIONING CORRECTLY

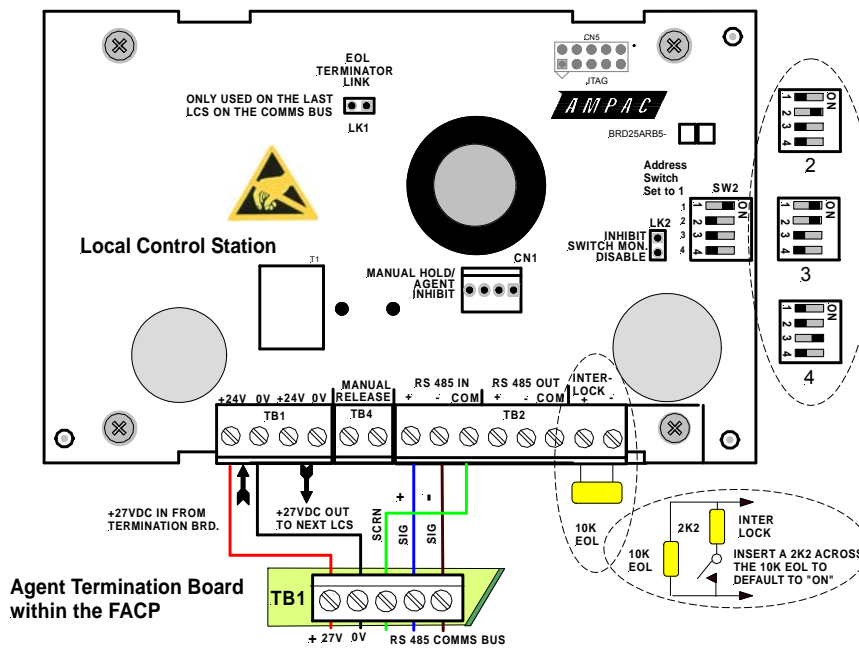

Figure 112: PCB Layout & Cabling Details

12.17.4 Agent Release Termination Board

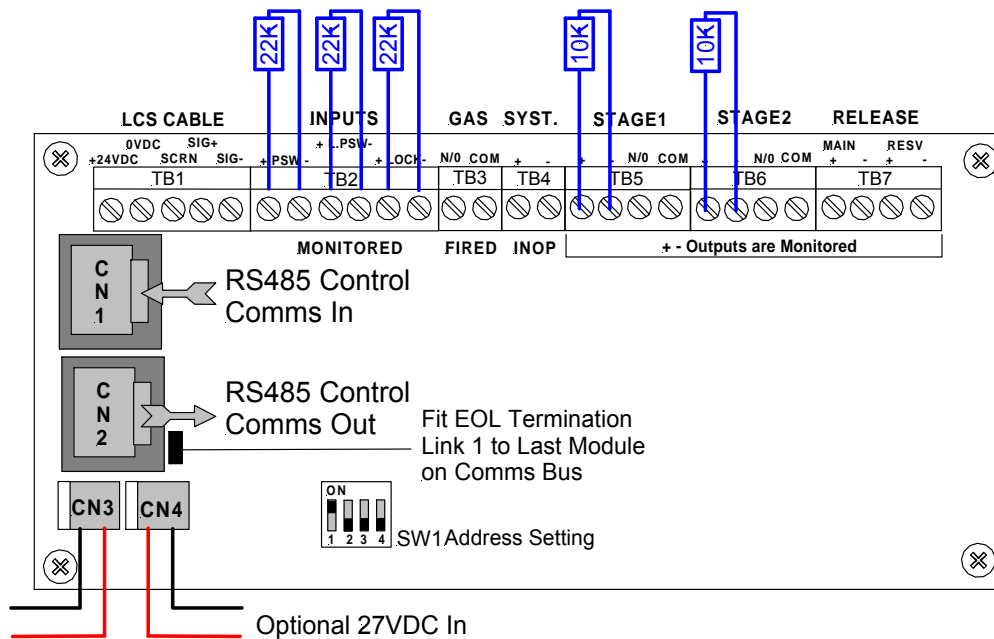

Figure 113: Agent Termination Board PCB Layout

The Agent Termination Board interfaces to;

1. The FACP via CN1, CN2 continuing the RS485 communications bus if required. LK1 is inserted if this is the last backpan board on the bus.
2. LCS's (up to 4) via TB1. LK1 is inserted in the last board in the RS485 Bus
3. Monitored Inputs: via TB2. (EOL Resistance 22KΩ, Series Resistance 4K7Ω)
  - i. Pressure Switch (PSW) agent released
  - ii. Low Pressure Switch (LPSW) agent storage cylinder pressure has dropped to a pre-determined level; and
  - iii. Interlock, the manual lock-off valve has been operated.
4. Gas Fired: Output via RL2 N/O contacts rated at 1A @ 24VDC wired to TB3. Used to indicate to other monitoring devices the agent has been released.
5. System Inoperative: via RL1 N/O contacts rated at 1A @ 24VDC wired to TB4. Used to warn by way of signage / audible alarm and/or monitoring that the system is inoperative.
6. Stage 1: Output; initiates the visual and audible Fire Alarm and Evacuate warnings.
  - i. Monitored; via RL4 C/O contacts wired to TB5 1 & 2 (EOL required 10KΩ) and
  - ii. Un-monitored; via RL5 N/O contacts wired to TB5 3 & 4.
7. Stage 2: output; initiates the visual and audible Fire Alarm and Do No Enter warnings
  - i. Monitored; via RL6 C/O contacts wired to TB6 1 & 2; (EOL required is 10KΩ) and
  - ii. Un-monitored; via RL3 N/O contacts wired to TB6 3 & 4
8. Release: Main actuating circuit, monitored (10KΩ EOL required) via TB7 1 & 2 (2A current limited),
9. Release: Reserve actuating circuit, monitored (10KΩ EOL required) via TB7 3 & 4 (2A current limited)

**Note 1:** Metron Igniters - (max of 10 – a series 2watt 18Ω resistor must be added to the circuit)

**Note 2:** Solenoid valve - (max current of 2 amps & 27VDC)



### 12.17.5 Interface Wiring

#### Monitored Inputs TB2 1 & 2

##### Solenoid & Metron

This input relies on N/O or N/C relay contacts used in conjunction with 22KΩ EOL and 4K7Ω series resistors. The type of agent release mechanism and contacts used has to be set in the Programming Menu for the input to function as per the manufacturers specifications and be in accordance with the relevant Standard.

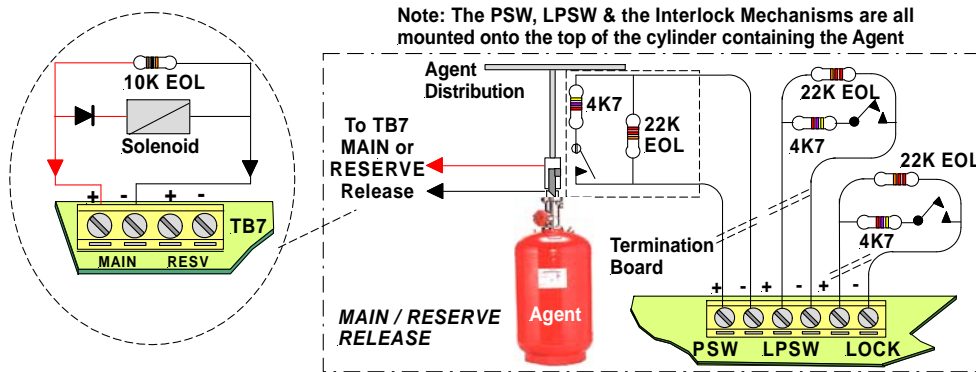

Figure 114: Solenoid, Metron PSW, LPSW and "LOCK" TB3 Wiring

##### LPSW & Lock

These inputs are also monitored and should be wired as shown above

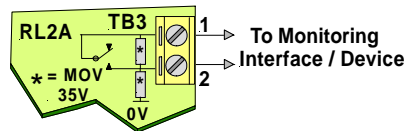

Figure 115 Gas Fired Wiring

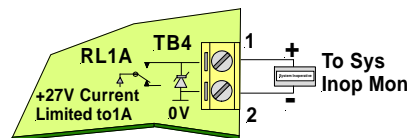

Figure 116: System Inoperative Wiring

As can be seen from above the;

1. Gas Fired Output can be wired to any interfacing or 1A monitoring circuit that requires a closed relay contact to indicate a change of state. This could be a relay or a solid state device.
2. System Inoperative Outputs 27V @ 1A to supply interfacing, signage and aural alarms to indicate the system has been taken out of service or has developed a fault.

#### Stage 1, Stage 2

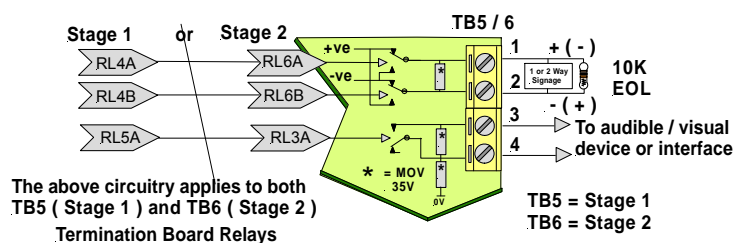

Figure 117: Stage 1 & 2 Wiring

### 13 Expanding the System Through Networking

Expanding the system can be achieved in various ways and requires the use of boards specifically designed for communications purposes and boards that actually expand the system.

#### 13.1 Networking

When FACP's are connected to each other they form a "NETWORK". Individual FACP's in the Network are referred to as NODES. The Network as defined by the limitations of the installation can consist of a number of Nodes, the number of Nodes being dependant on the configuration of each Node. Typically an entire Network could consist of 60 Slave CPU's connected to loops and or input / output devices spread over several nodes. The Network is Peer to Peer with the entire system configuration being stored at each Node. The system is then programmed so that information can be made invisible to particular Nodes or visible to all Nodes. Likewise system commands can be global or restricted to specific parts of the network.

The entire system can be programmed from any Node in the Network and is connected as a data loop which provides redundancy should there be a single cabling fault.

**IMPORTANT**

While it is important that proper documentation is kept and maintained for any installation it becomes even more important as a system develops into the larger types described above.

#### 13.2 Network Interface Card

The Network Interface Board provides the RS485 communication buses via CN18 on the Main Controller (Loop Comms) to allow the networking of multiple panels in different combinations, e.g. from Data Gathering Panels (DGP) to Peer to Peer panels.

The Bias SW2 defaults to ON. SW2 is only switched to OFF when direct connecting the network to external devices such as Optical Fibre Modems.

The Isolate SW3 Allows the network node to be isolated from the network

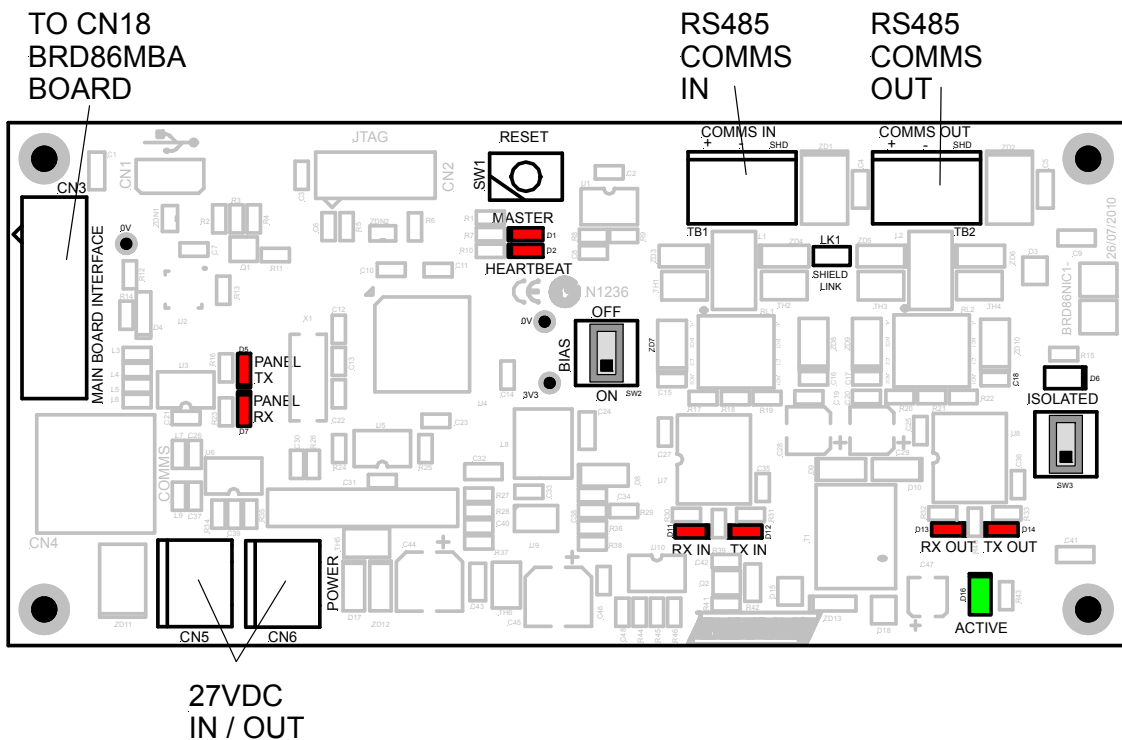

Figure 118: Network Interface Board Layout

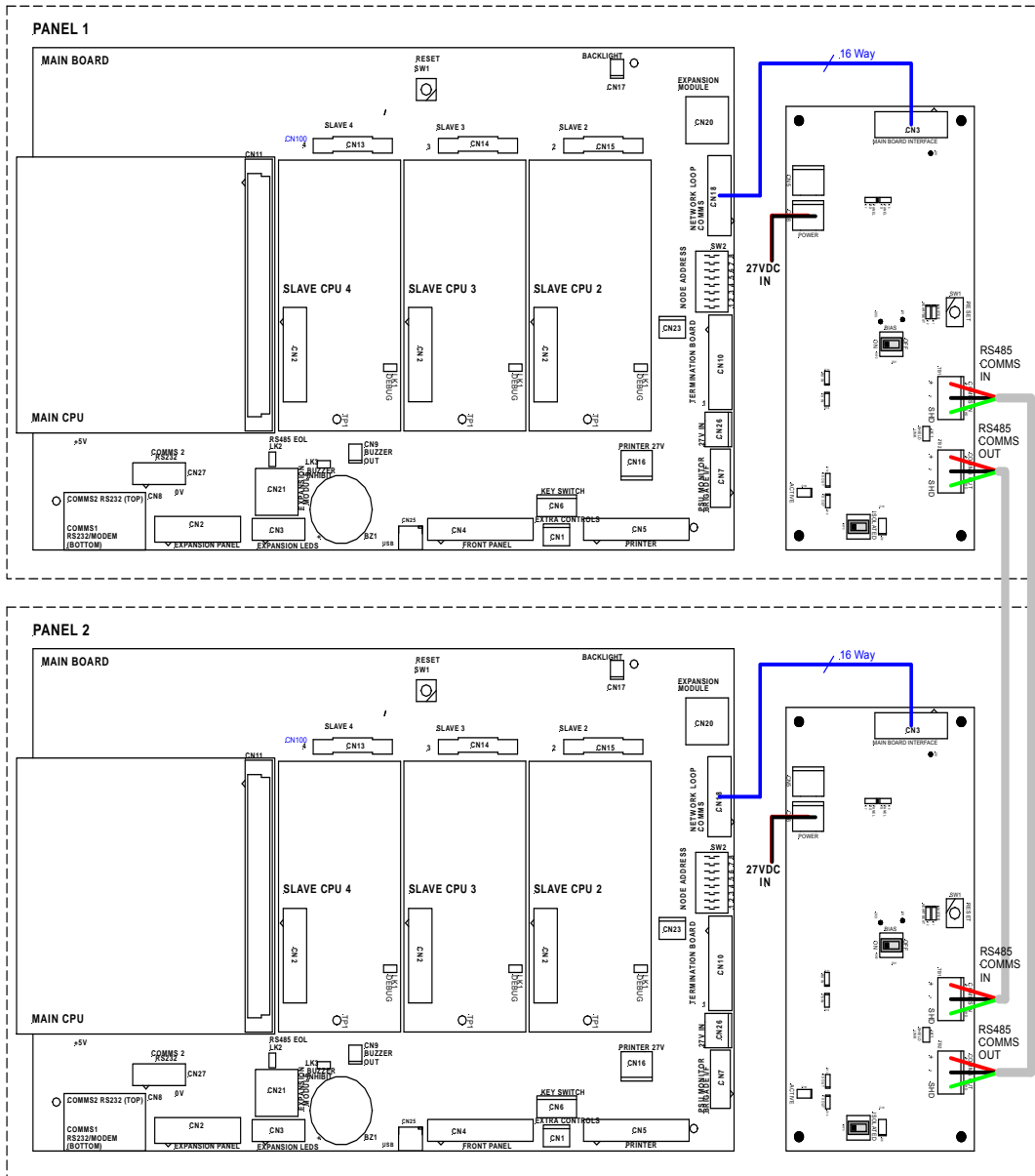

Figure 119: Basic 2 node system using a Network Interface card

### 13.3 High Level Interface Expander

#### Hardware

The High Level Interface Expander (BRD43SPB) consists of a serial port under the control of a microcontroller. Communications between the FACP and this board is via the RS485 control bus with each board having a dedicated link and selectable 4 bit address.

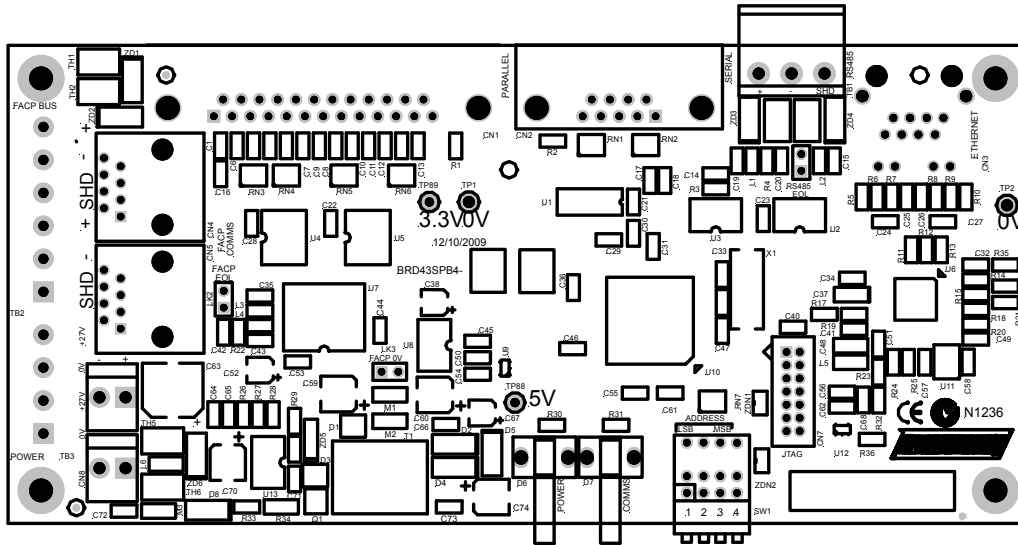

Figure 120: High Level Interface Expander PCB Layout

#### Software

The Serial/USB port supports the following protocols:-

**HLI** – Functionality matches the **FireFinder PLUS** panel which supports text or positive ack protocol. Configurable attributes are: logical output, physical output, alarm output, pre-alarm output, fault output, isolate output and descriptors

- SmartGraphics interface** - Serial Port or RS485 Port
- MODBUS interface** - Serial Port or RS485 Port
- EV3000** - RS485 port
- SMS capability via GSM modem** - Serial or USB port

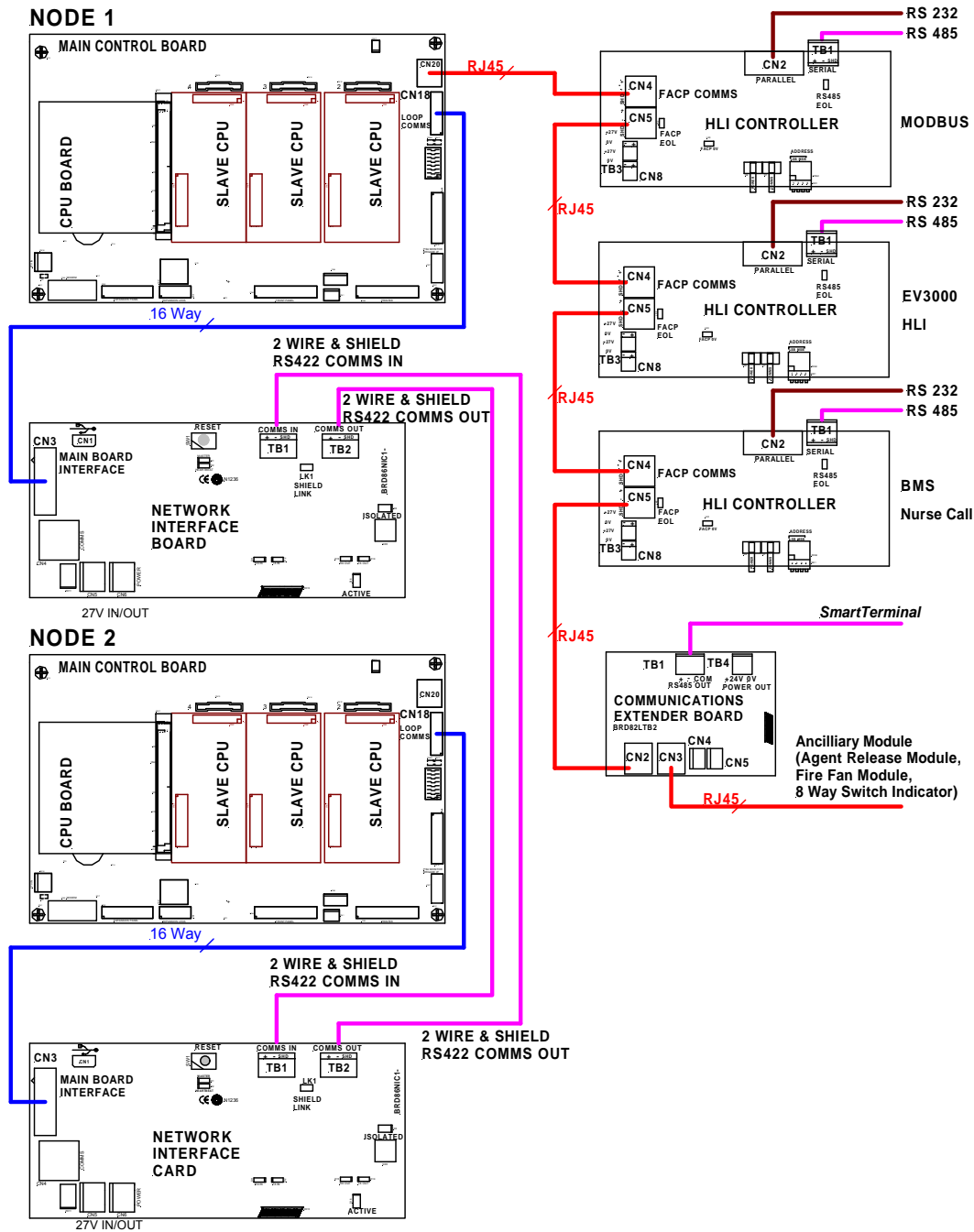

Figure 121: Example of Networking Configurations

**Note:** Maximum distances between panels = 1.2km.

## 14 Certification Information

The *FireFinder Plus* is designed and manufactured by:

AMPAC TECHNOLOGIES PTY LTD

7 Ledger Rd

Balcatta

WA 6021

Western Australia

PH: 61-8-9242 3333

FAX: 61-8-9242 3334



Manufactured to: \_\_\_\_\_

Certificate of Compliance Number: \_\_\_\_\_

Equipment Serial Number: \_\_\_\_\_

Date of Manufacture: \_\_\_\_\_

## 15 Maintenance and Troubleshooting Chart

### 15.1 Maintenance

The **FireFinder PLUS** FACP should be maintained so as to comply with all standards / regulations applicable to the country and location it has been installed. Failure to do so could put at risk compliance and the integrity of the system. As a minimum it is recommended the following be used as a guide to periodic maintenance especially if there is an absence of standards regulations.

#### General

To implement a site maintenance regime, responsibilities should be established by responsible persons, training implemented if required, maintenance delegates appointed and all outcomes clearly communicated to all parties.

#### Daily Operations (operator level)

- The delegated operator checks for normal operation
- If any faults are detected, record them in an established "Site Log Book" and report them to the assigned body.
- Ensure all faults are signed off as they are resolved and follow up on those that are still outstanding.

#### Monthly Operations (operator level)

- In addition to Daily Operational checks
- Visually inspect in and around the panel for any signs of pests, moisture or general damage
- Ensure any non FACP standby power facilities are in a state of operational readiness
- Force a suitable device, such as an MCP or detector, into an alarm state so that it generates a know alarm outcome. This process should be controlled and established in consultation with all interested parties (installing engineers include) so that maximum benefit is obtained from the test.
- Ensure the Site Log Book" is up to date, faults have been attended to and the latest test are recorded

#### Quarterly Operations (service contractor)

- In addition to Monthly Operational checks
- Check all internal connections and perform "alarm", "fault" and site specific tests
- Perform a "walk around" of the site to determine if the system integrity is free of possible faults
- Ensure the Site Log Book" is up to date, faults have been attended to and the latest test are recorded

#### Annual Operations (service contractor)

- In addition to Monthly Operational checks
- Initiate both a "lamp" and "walk" test and any other tests as determined necessary for the site
- Inspect and test ( as per the manufacturers specifications ) batteries
- Ensure the Site Log Book" is up to date, faults have been attended to and the latest test are recorded

#### Replacement Components (service contractor)

Batteries and fuses are seen as the only field replaceable components.

If a board field change is required all necessary anti-static precautions must be taken.



**Note:** *If the Main Board is changed the power supply may require re-calibration.*

### 15.2 Troubleshooting *FireFinder PLUS*

**i** Resolution of all suspected faults MUST only be carried out by suitably qualified technical operatives.

Problem	Solution
No Mains Power	Check mains Fuse
Supply fault LED illuminated	Check output voltage it should be set to 27.6V. Low = (less than 26.5V ) High = (greater than 28V ) Check the battery has been connected properly
Earth Fault LED illuminated	Check all input and output cabling and wiring assemblies for short to ground
System Fault LED illuminated	Ensure correct software is installed Check all connections for loose wiring
Warning System Fault LED illuminated	Check correct E.O.L is fitted (10K) Check wiring is connected correctly
Maintenance Alarm cleared but <b>FireFinder PLUS</b> still displays Maintenance Alarm	Carry out Loop Test
LCD displays LOOP (number) open circuit	Check in and out legs are connected correctly at the loop termination board
Unable to clear an O/C or S/C on a loop	You must perform a loop test to clear the fault. This is a level 1 function.
Communication Loop not working	Check for correct software installed in all communication boards. Check LCD at Main controller. This may identify where there is a break in the communication line
Can not access Function menu	Incorrect Password entered
Forgotten password	Ring AMPAC and directions will be given to provide you with a temporary code
An Analogue Fault occurs when using a Zone Monitor to monitor a switch.	A 1.8k Ohm resistor must be placed in series with the switch contacts.
Sounder Fault	Make sure you have a 10K Ohm EOL resistor fitted and a diode (1N4004) in series with the sounder



## 16 Compatible Devices

AMPAC Type Code	Auto Learn Default	Device Type	Displayed Type (19 chars)	Type Desc
		<b>Optical</b>		
05h	✓	XP95 Optical	XP95 PHOTO	PHOTO
05h		XP95 Optical with base sounder	XP95 PHOTO + SNDR	PHOTO
05h		XPander Optical	XPANDER PHOTO	PHOTO
05h		S90 Optical	S90 PHOTO	PHOTO
05h		Xplorer Optical	XPLORER PHOTO	PHOTO
05h		Xplorer Optical with base sounder	XPLR PHOTO + SNDR	PHOTO
05h		XP95 Beam	XP95 BEAM	PHOTO
0Dh	✓	XP95 Reflective beam	XP95 REFLECT BEAM	BEAM
105h	✓	Discovery Optical	DISC PHOTO	PHOTO
105h		Discovery Optical with base sounder	DISC PHOTO + SNDR	PHOTO
11Dh	✓	Discovery Multisensor	DISC MULTISENSOR	MULTI
11Dh		Discovery Multisensor with base sounder	DISC MULTI + SNDR	MULTI
15h	✓	XP95 Flame	XP95 FLAME	FLAME
1Dh	✓	XP95 Multisensor	XP95 MULTISENSOR	MULTI
1Dh		XP95 Multisensor with base sounder	XP95 MULTI + SNDR	MULTI
1Dh		XPander Multisensor	XPANDER MULTI	MULTI
31Dh	✓	Enhanced Discovery Multisensor	EDSC MULTISENSOR	MULTI
31Dh		Enhanced Discovery Multi + base sounder	EDSC MULTI + SNDR	MULTI
		<b>Heat Detectors</b>		
06h	✓	XP95 Heat	XP95 HEAT	HEAT
06h		XP95 Heat with base sounder	XP95 HEAT + SNDR	HEAT
06h		XPander Heat	XPANDER HEAT	HEAT
06h		S90 Heat	S90 HEAT	HEAT
06h		Xplorer Heat	XPLORER HEAT	HEAT
06h		Xplorer Heat with base sounder	XPLR HEAT + SNDR	HEAT
0Eh	✓	XP95 Hi temp	XP95 HI HEAT	HHEAT
0Eh		XP95 Hi temp with base sounder	XP95 HI HEAT + SNDR	HHEAT
0Eh		XPander Hi temp	XPANDER HI HEAT	HHEAT
0Eh		Xplorer Hi temp	XPLORER HI HEAT	HHEAT
0Eh		Xplorer Hi temp with base sounder	XPLR HI HEAT + SNDR	HHEAT
106h	✓	Discovery Heat	DISC HEAT	HEAT
106h		Discovery Heat with base sounder	DISC HEAT + SNDR	HEAT
		<b>Ionisation</b>		
03h	✓	XP95 Ion	XP95 ION	ION
03h		XP95 Ion with base sounder	XP95 ION + SNDR	ION
03h		S90 Ion	S90 ION	ION
103h	✓	Discovery Ion	DISC ION	ION
103h		Discovery Ion with base sounder	DISC ION + SNDR	ION
10Bh	✓	Discovery Carbon Monoxide	DISC CO	CO
10Bh		Discovery Carbon Monoxide with base sndr	DISC CO + SNDR	CO

<b>Manual Call Points</b>				
07h	✓	S90 MCP	S90 MCP	MCP
11Fh	✓	Discovery MCP	DISC MCP	MCP
1Fh	✓	XP95 MCP	XP95 MCP	MCP
1Fh		XPander MCP	XPANDER MCP	MCP
1Fh		XP95 Mini switch monitor with interrupt	XP95 MINI SW + INT	MCP
1Fh		Xplorer MCP	XPLORER MCP	MCP
<b>Sounders</b>				
01h	✓	XP95 sounder / sounder control unit	XP95 SOUNDER	SNDR
01h		XPander sounder	XPANDER SOUNDER	SNDR
01h		XP95 integrated base sounder	XP95 INTGR BSE SNDR	SNDR
01h		XP95 Intelligent base sounder	XP95 INTEL BSE SNDR	SNDR
01h		XP95 sounder beacon base	XP95 SND BEACN BSE	SNDR
01h		XP95 loop powered beacon	XP95 LOOP PWR BEACN	SNDR
01h		S90 sounder control unit	S90 SCU	SNDR
111h	✓	Discovery sounder beacon base/open area	DISC SOUNDER BEACN	SNDR
<b>I/O Units</b>				
02h	✓	XP95 input / output module	XP95 I/O	I/O
02h		XPander I/O (Relay) Unit	XPANDER I/O	I/O
02h		XP95 three channel input / output module	XP95 3I/O	I/O
02h		XP95 output module	XP95 OUTPUT	I/O
02h		XP95 mains switching input / output module	XP95 MAINS I/O	I/O
02h		S90 single channel I/O unit	S90 SINGLE I/O	I/O
02h		S90 3 channel I/O unit	S90 3I/O	I/O
02h		S90 3 channel analogue I/O unit	S90 3I/O + ANALOGUE	I/O
02h		S90 switch monitor unit	S90 SWITCH	I/O
02h		Xplorer output module	XPLORER OUTPUT	I/O
<b>Zone Monitors</b>				
04h	✓	XP95 zone monitor	XP95 ZONE MONITOR	CONV
04h		XPander Loop Interface	XPANDER INTERFACE	RADIO
04h		S90 zone monitor	S90 ZONE MONITOR	CONV
0Ch	✓	XP95 switch monitor	XP95 SWITCH	SWITCH
0Ch		XP95 mini switch monitor	XP95 MINI SWITCH	SWITCH
0Ch		XP95 switch monitor plus	XP95 SWITCH PLUS	SWITCH
1Ch	✓	FastSense XP95 APIC	XP95 FASTSENSE	FSENSE
<b>User Defined</b>				
10h	✓	XP95 AAF	XP95 AAF	AAF

# 17 Address Setting

## BINARY ADDRESS SETTING (APOLLO)

### SERIES XP95 - ADDRESS DATA

DIL SWITCH: ON = 1 OFF = 0 ADDRESS TAG FOR DETECTORS (I/O DEVICES)

DIL switch setting		DIL switch setting		DIL switch setting		DIL switch setting		DIL switch setting	
Address	1234567	Address	1234567	Address	1234567	Address	1234567	Address	1234567
1	1000000	26	0101100	51	1100110	76	0011001	101	1010011
2	0100000	27	1101100	52	0010110	77	1011001	102	0110011
3	1100000	28	0011100	53	1010110	78	0111001	103	1110011
4	0010000	29	1011100	54	0110110	79	1111001	104	0001011
5	1010000	30	0111100	55	1110110	80	0000101	105	1001011
6	0110000	31	1111100	56	0001110	81	1000101	106	0101011
7	1110000	32	0000010	57	1001110	82	0100101	107	1101011
8	0001000	33	1000010	58	0101110	83	1100101	108	0011011
9	1001000	34	0100010	59	1101110	84	0010101	109	1011011
10	0101000	35	1100010	60	0011110	85	1010101	110	0111011
11	1101000	36	0010010	61	1011110	86	0110101	111	1111011
12	0011000	37	1010010	62	0111110	87	1110101	112	0000111
13	1011000	38	0110010	63	1111110	88	0001101	113	1000111
14	0111000	39	1110010	64	0000001	89	1001101	114	0100111
15	1111000	40	0001010	65	1000001	90	0101101	115	1100111
16	0000100	41	1001010	66	0100001	91	1101101	116	0010111
17	1000100	42	0101010	67	1100001	92	0011101	117	1010111
18	0100100	43	1101010	68	0010001	93	1011101	118	0110111
19	1100100	44	0011010	69	1010001	94	0111101	119	1110111
20	0010100	45	1011010	70	0110001	95	1111101	120	0001111
21	1010100	46	0111010	71	1110001	96	0000011	121	1001111
22	0110100	47	1111010	72	0001001	97	1000011	122	0101111
23	1110100	48	0000110	73	1001001	98	0100011	123	1101111
24	0001100	49	1000110	74	0101001	99	1100011	124	0011111
25	1001100	50	0100110	75	1101001	100	0010011	125	1011111
								126	0111111

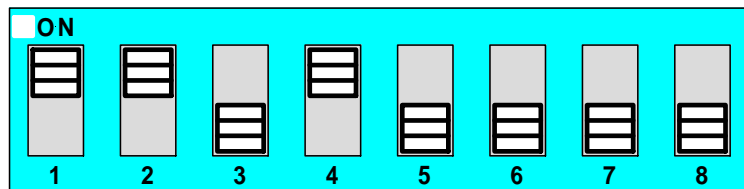
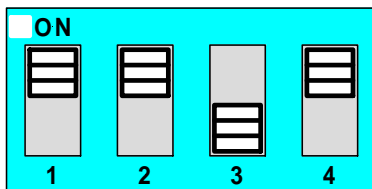
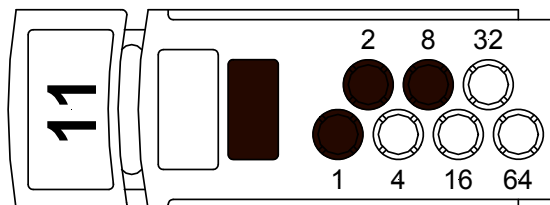

Figure 122: 4 and 8 way Switch addressing set to Address 11



● = PUNCH OUT

Figure 123: Xpert Card addressing set to Address 11

## 18 Glossary of Terms

ACF:	ANCILLARY CONTROL FACILITY
ACKD:	ACKNOWLEDGED
AHU:	AIR HANDLING UNIT
ALM:	ALARM
AVF:	ALARM VERIFICATION FACILITY
AZF:	ALARM ZONE FACILITY
AZC:	ALARM ZONE CIRCUIT
C:	RELAY COMMON CONTACT (WIPER)
CIC:	CONTROLLER INTERFACE CARD
CN:	CONNECTOR
CPU:	COMMON PROCESSOR UNIT
DGP:	DATA GATHERING POINT
EARTH:	BUILDING EARTH
EOL:	END OF LINE
FDS:	FIRE DETECTION SYSTEM
FACP:	FIRE ALARM CONTROL PANEL
FLT:	FAULT
GND:	GROUND (0 VOLTS) NOT EARTH
I/O:	INPUT/OUTPUT
LCD:	LIQUID CRYSTAL DISPLAY
MAF:	MASTER ALARM FACILITY
MCP:	MANUAL CALL POINT
MOV:	METAL OXIDE VARISTOR (TRANSIENT PROTECTION)
NIC:	NETWORK INTERFACE CARD
N/C:	NORMALLY CLOSED RELAY CONTACTS
N/O:	NORMALLY OPEN RELAY CONTACTS
NW:	NETWORK
PCB:	PRINTED CIRCUIT BOARDS
P/S:	POWER SUPPLY
PSM:	POWER SUPPLY MODULE
REM:	REMOTE
SPOT:	SINGLE PERSON OPERATING TEST
TB:	TERMINAL BLOCK
VDC:	DIRECT CURRENT VOLTS

## 19 Definitions

**Addressable system** - a fire alarm and detection system that contains addressable alarm zone facilities or addressable control devices.

**Alarm Verification Facility (AVF)** - that part of the FACP, which provides an automatic resetting function for spurious alarm signals so that they will not inadvertently initiate Master Alarm Facility (MAF), or ACF functions. Using ConfigManager prior to downloading to the **FireFinder PLUS** sets this option

**Alarm zone** - the specific portion of a building or complex identified by a particular alarm zone facility.

**Alarm Zone Circuit (AZC)** - the link or path that carries signals from an actuating device(s) to an alarm zone facility(s).

**Alarm Zone Facility (AZF)** - that part of the control and indicating equipment that registers and indicates signals (alarm and fault) received from its alarm zone circuit. It also transmits appropriate signals to other control and indicating facilities.

**Alert signal** - an audible signal or combination of audible and visible signals, from the occupant warning system to alert wardens and other nominated personnel as necessary to commence prescribed actions.

**Ancillary Control Facility (ACF)** - that portion of the control and indicating equipment that on receipt of a signal initiates predetermined actions in external ancillary devices.

**Ancillary equipment** - remote equipment connected to FACP.

**Ancillary relay** - relay within FACP to operate ancillary equipment.

**Ancillary output** - output for driving ancillary equipment.

**Approved and approval** - approved by, or the approval of, the Regulatory Authority concerned.

**Card-detect link** - a link on a module connector to indicate the disconnection of the module.

**Conventional System** - is a fire detection system using a dedicated circuit for each alarm zone.

**Distributed system** - a fire alarm and detection system where sections of the control and indicating equipment are remotely located from the FACP or where sub-indicator panel(s) communicate with a main FACP.

**Field connections** - are connections made to FACP or ancillary equipment during installation.

**Fire alarm system** - an arrangement of components and apparatus for giving an audible, visible, or other perceptible alarm of fire, and which may also initiate other action.

**Fire detection system** - an arrangement of detectors and control and indicating equipment employed for automatically detecting fire and initiating other action as arranged.

**Fire Alarm Control Panel (FACP)** - a panel on which is mounted an indicator or indicators together with associated equipment for the fire alarm or sprinkler system.

**Fire resisting** - an element of construction, component or structure which, by requirement of the Regulatory Authority, has a specified fire resistance.

**Indicating equipment** - the part of a fire detection and or alarm system, which provides indication of any warning signals (alarm and fault), received by the control equipment.

**Interface** - The interconnection between equipment that permits the transfer of data.

**Main equipment** - equipment essential to the operation of the system including, control equipment, amplification equipment and power supply modules.

**Master Alarm Facility (MAF)** - that part of the equipment which receives alarm and fault signals from any alarm zone facility and initiates the common signal (alarm and/or fault) for transmission to the fire control station. Bells and other ancillary functions may be initiated from this facility.

**Power Supply** - that portion of the FACP which supplies all voltages necessary for its operation.

**Regulatory Authority** - an authority administering Acts of Parliament or Regulations under such Acts

## 20 Specifications

	Metal SP1M	Metal SP8M/8X
<b>Mechanical</b>		
Dimensions Cabinet: ( mm )	505 (H) x 407 (W) x 150 (D)	845 (H) x 518.5 (W) x 173(D)
Material	1.2mm Mild Steel	1.2mm Mild Steel
<b>Environmental</b>		
Temperature:	-5°C to + 40°C	
Humidity:	25% to 95% non condensing	
IP rating	IP30	
<b>Mains Input</b>		
Input Voltage:	195 - 264VAC	195 - 264VAC
Protection (Quick Acting Fuse):		
5 AMP Supply	2Amp 3AG Slow Blow	2A 3AG Slow Blow
14 AMP Supply	N/A	5A 3AG Slow Blow
Minimum Cable Requirements:	Not less than 0.75mm <sup>2</sup>	Not less than 0.75mm <sup>2</sup>
<b>Power Supply</b>		
Operating Voltage Range:	20 - 28.2VDC	20 - 28.2VDC
Power Supply Ripple Voltage:	<250mV	<250mV
Power Supply Output Current:	5.6Amps	5.6Amps / 14Amps
Imax A	3Amps	
Imax B	5.5Amps	
Protection	Current Limiting	Current Limiting
<b>Batteries / Battery Charger</b>		
Charger Float Voltage (Temp compensated):	26.6-28.2VDC (27.3VDC nom @ 20°C)	26.6-28.2VDC (27.3VDC nom @ 20°C)
Approved LPCB Battery:	Genesis NP24-12R	
Battery Type:	2x12V Sealed Lead Acid	2x12V Sealed Lead Acid
Max Battery Capacity:	24AH	40AH
Max Charger Current Limited:	1.25A	2A
Battery Supply Current Limited:	3A and 2A PTC	3A and 2A PTC
Battery Low:	<23VDC	<23VDC
Battery Discharged Cut-off Voltage:	<21VDC	<21VDC
Max Battery Resistance	0.75Ω	0.43Ω
<b>Panel</b>		
Quiescent Current ( QI ) 1 Loop	220mA	
Max Number of Zone LEDs:	64	128
<b>Loop</b>		
Maximum number of Loops:	4	8
Maximum Number of Zones:	64	128
Maximum Number of Devices:	126 / loop	126 / loop
Loop Current	500mA / loop	500mA / loop
Cabling Requirements:	2 core 1.5 -2.5mm <sup>2</sup> Max length 1km	2 core 1.5 -2.5mm <sup>2</sup> Max length 1km
Fault supervision:	O/C, S/C , over current	O/C, S/C , over current
<b>Outputs</b>		
Supervised Alarm (Current Limited)	24VDC @ 1A Max O/C, S/C, 10K EOL	
Alarm / Fault Relay Contacts	24VDC @ 1A	
Auxiliary VDC – Protected	24VDC @ 2A	
Cabling Requirements:	2 core 1 -2.5mm <sup>2</sup> Max length 1km	
<b>Inputs</b>		
Supervised	O/C, S/C, 10K EOL	
Cabling Requirements:	2 core 1 -2.5mm <sup>2</sup> Max length 1km	
<b>Communications</b>		
Add-on Module Internal to FACP	RS485	
External to FACP	RS485	

	Metal SP1X	Metal SP16X
<b>Mechanical</b>		
Dimensions Cabinet: ( mm )	505 (H) x 407 (W) x 150 (D) Includes window outer door	1200 (H) x 625 (W) x 240 (D) Includes window outer door
Material	1.2mm Mild Steel	1.2mm Mild Steel
<b>Environmental</b>		
Temperature:	-5°C to + 40°C	
Humidity:	25% to 95% non condensing	
IP rating	IP30	
<b>Mains Input</b>		
Input Voltage:	195 - 264VAC	195 - 264VAC
Protection (Quick Acting Fuse):		
5 AMP Supply	2Amp 3AG Slow Blow	N/A
14 AMP Supply	N/A	5A 3AG Slow Blow
Minimum Cable Requirements:	Not less than 0.75mm <sup>2</sup>	Not less than 0.75mm <sup>2</sup>
<b>Power Supply</b>		
Operating Voltage Range:	20 - 28.2VDC	20 - 28.2VDC
Power Supply Ripple Voltage:	<250mV	<250mV
Power Supply Output Current:	5.6Amps	14Amps
Imax A	3Amps	
Imax B	5.5Amps	
Protection	Current Limiting	Current Limiting
<b>Batteries / Battery Charger</b>		
Charger O/P Voltage (Temp compensated):	26.6-28.2VDC (27.3VDC nom @ 20°C)	26.6-28.2VDC (27.3VDC nom @ 20°C)
Approved LPCB Battery:		
Battery Type:	2x12V Sealed Lead Acid	2x12V Sealed Lead Acid
Max Battery Capacity:	17AH	40AH
Max Charger Current Limited:	1.25A	2A
Battery Supply Current Limited:	3A and 2A PTC	3A and 2A PTC
Battery Low:	<23VDC	<23VDC
Battery Discharged Cut-off Voltage:	<21VDC	<21VDC
Max Battery Resistance	0.75Ω	0.43Ω
<b>Panel</b>		
Quiescent Current ( QI ) 1 Loop	220mA	
Max Number of Zone LEDs:	64	128 +
<b>Loop</b>		
Maximum number of Loops:	4	16 (Two networked nodes)
Maximum Number of Devices:	126 / loop	126 / loop
Loop Current	500mA / loop	500mA / loop
Cabling Requirements:	2 core 1.5 -2.5mm <sup>2</sup> Max length 1km	2 core 1.5 -2.5mm <sup>2</sup> Max length 1km
Fault supervision:	O/C, S/C , over current	O/C, S/C , over current
<b>Outputs</b>		
Supervised Alarm (Current Limited)	24VDC @ 1A Max O/C, S/C, 10K EOL	
Alarm / Fault Relay Contacts	24VDC @ 1A	
Auxiliary VDC – Protected	24VDC @ 2A	
Cabling Requirements:	2 core 1 -2.5mm <sup>2</sup> Max length 1km	
<b>Inputs</b>		
Supervised	O/C, S/C, 10K EOL	
Cabling Requirements:	2 core 1 -2.5mm <sup>2</sup> Max length 1km	
<b>Communications</b>		
Add-on Module Internal to FACP	RS485	
External to FACP	RS485	









[www.ampac.net](http://www.ampac.net)



**UNCONTROLLED DOCUMENT**

*NOTE: Due to AMPAC's commitment to continuous improvement specifications may change without notice.*