



ADVANCED WARNING

SYSTEMS

FireFinder



**Fire Alarm Control Panel
Series II (Nzs4512)**

Config Manager Version 6

MAN 2600-2

WORLD LEADER OF INNOVATIVE SOLUTIONS
IN FIRE DETECTION AND ALARM SYSTEMS



TABLE OF CONTENTS

Page No.

1	<i>About This Manual</i>	1
1.1	Introduction	1
1.2	General Requirements	1
1.3	References.....	1
1.4	Symbols.....	1
2	<i>Installation</i>	2
3	<i>The Functions Menu and Tool Bar</i>	3
3.1	The Menu Bar	3
3.1.1	File.....	3
3.2	Connect	4
3.2.1	Connect to <i>FireFinder Series II</i>	4
3.3	Tools.....	4
3.3.1	Verify Project (F4)	4
3.3.2	Compile File (F5).....	4
3.3.3	Convert File from <i>FireFinder Series II</i> System.....	4
3.3.4	Clean Up Directory	4
3.4	Options	4
3.4.1	Environment Settings	4
3.4.1.1	Colours:.....	5
3.4.1.2	Layout:	5
3.4.1.3	Compile:.....	6
3.4.1.4	Project Creation:.....	7
3.4.1.5	Communications:.....	8
3.4.1.6	File Association:	9
3.4.1.7	Apollo Input/Output.....	9
3.4.2	Window	10
3.4.3	Help	10
4	<i>Creating a New Project</i>	11
4.1	The Systems Settings Dialogue Box.....	11
4.1.1	Base Settings	11
4.1.2	Display settings	12
4.1.3	Quick Set settings	12
4.1.4	System (SmartGraphics) Interface.....	13
4.2	The New Project Screen.....	13
4.3	The Project View	14
4.4	Panel Settings or Editing	15
4.4.1	Main Information.....	15
4.4.2	Brigade Signaling Board.....	16
4.4.3	Call Point / DBA	17
4.4.4	Bell Sounder Boards.....	18
4.5	Network Parameters:.....	19
4.6	Controller Configuration.....	20
4.6.1	Setting or Editing the Controller Module Types:	20
4.6.2	Rearranging Module Order	20
4.6.3	Controller Setting or Editing.....	21

4.6.4	Adding More Controllers / Adding More Modules	22
4.6.5	Edit External LED Mimic.....	22
4.6.6	Edit Internal Serial	24
4.6.7	Edit Fan Control	25
4.6.8	Edit Switch & Indicator.....	28
4.6.9	Edit SmartTerminal.....	29
4.6.10	Single Panels	30
4.6.11	Modules	30
5	<i>The Module Data Entry Spreadsheet.....</i>	31
5.1	Type and Zone Configuration (Zone Cnfg).....	31
5.1.1	Specific Device Settings	33
5.1.2	Input Output Device Settings	33
5.2	The Extended Menu and Toolbar.....	35
5.2.1	File.....	36
5.2.2	Edit	37
5.2.3	Search	38
5.2.4	View.....	38
5.2.5	Tools.....	39
5.2.6	Clicking Icons	40
5.3	Apollo Modules.....	41
5.3.1	Edit Sensor Properties.....	41
5.3.2	Input/Output Settings.....	43
5.3.3	Day/Night Settings.....	45
5.4	Conventional Modules	46
5.5	Input/Output Modules	47
5.6	<i>SmartTerminal</i>	48
6	<i>Functions.....</i>	49
6.1	The Function View.....	49
7	<i>Expanding the System</i>	53
7.1	Adding a Panel.....	53
7.2	Adding a Data Gathering Point	54
7.3	Adding an LCD Mimic.....	55
7.3.1	Global Access	55
7.3.2	Panel, Loop or Group Access	56
7.3.3	Mimic Settings.....	56
7.4	Adding Modules to a Panel.....	57
7.5	Adding a High Level Interface (HLI)	59
7.5.1	High Level Interface Options (HLI).....	59
7.6	Data Output.....	62
7.6.1	Option 1 - Physical Output Enabled	62
7.6.2	Option 2 - Physical and Logical Output Enabled	62
7.6.3	Option 3 - Logical Output Enabled	62
7.7	Interface Configuration	63
8	<i>Network Panels.....</i>	64
9	<i>Introduction to Programming</i>	65
9.1	Boot Software:.....	65

9.2	Application Software:.....	65
9.3	Configuration Software:	65
10	Hardware requirements.....	66
11	Configuration Programming	67
11.1	Transfer – Transfer Wizard.....	68
11.1.1	Transfer – Terminal Window	68
11.2	Uploading.....	69
11.3	Changing the Configuration Data in Diagnostics Mode.....	69
11.4	Installing Configuration Software Using a Computer or Laptop.....	69
11.5	Boot Mode To Change Application Software.....	70
11.6	Using a Modem	73
11.7	Wireless Modem	73
12	Network Programming	74
12.1	Part 1: Upgrading the Configuration.....	74
12.2	State of the Network.....	74
12.3	Network Go Diagnostic (NGD).....	75
12.4	Part 2: Upgrading the Application	79
13	Help Commands.....	85
13.1	Application Mode Help Commands (he).....	85
13.2	Advanced Application Mode Help Commands (hea)	85
13.3	Network Commands available (hen)	85
13.4	Boot Mode (he) (hea) (hen)	85
13.5	Diagnostic Mode (hea).....	86
13.6	Diagnostic Mode (he)	86
14	Troubleshooting.....	87
15	Decimal – Hexadecimal – Binary Conversion Table	88
16	Certification Information	90
17	Definitions	91

1 **About This Manual**

1.1 **Introduction**

Configuration Manager:

- Is a software tool designed and written by AMPAC Technologies Pty. Ltd to enable users to create configuration files for transfer to and from the **FireFinder Series II** Fire Alarm Control Panel.
- Is a universal program that meets the required standards of several different countries.
- Has been tested on Windows XP Vista and Win7 operating systems.

Included in the **FireFinder Series II** configuration is;

- A spreadsheet component for entering the configuration data for the loops / sensors zones (loop/conventional) and the inputs/outputs either in the panel or on the loops.
- A graphical interface for the entry of function data for input and output control.
- System networking ability.

1.2 **General Requirements**

The **FireFinder Series II** FACP has been designed and manufactured from high quality commercial components so as to comply with major world standards. To ensure these standards are not compromised in any way installation staff and operators should;

- Be qualified and trained for the task they undertake;
- Be familiar with the contents of this manual prior to the installation, commissioning or operation of a FireFinder control system;
- Observe anti-static pre-cautions at all times; and
- Be aware that if a problem is encountered or there is any doubt with respect to the operational parameters of the installation the supplier should be contacted.

1.3 **References**

ConfigManager

New Zealand Standard:

NZS4512: 2003 - Maintenance of Fire Protection Systems and equipment - Fire Detection and Alarm Systems.

1.4 **Symbols**

 Important operational information

 **Note:** Configuration considerations

 Observe antistatic precautions

2 *Installation*

To install the software insert the first CD into the disk drive and click on the Setup.exe file. ConfigManager will then automatically guide the operator through the installation.

To run the program, assuming the icon to the default Program Folder was added during the set-up

procedure, click on the  icon on the screen.

Alternatively, locate the folder C:\Program Files\AMPAC\Config Manager V6 via My Computer or Windows Explorer and double click on the ConMan6.exe file.

3 The Functions Menu and Tool Bar

Running ConfigManager will bring up a window with a Menu and Tool-bar in the top left hand corner of the screen as shown in the diagram below.

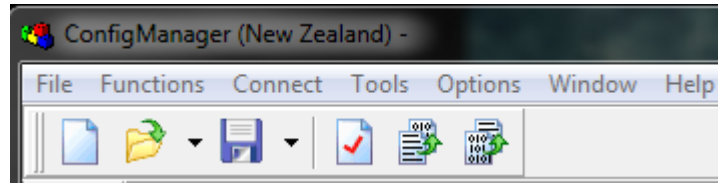

Figure 1: The Functions Menu and Tool Bar

3.1 The Menu Bar



3.1.1 File

This menu gives access to the following functions:

New (Project) [CTRL + N]: Select this option to start a new project. The System Settings dialogue box will appear as a result.

Open (Project) [CTRL + O]: This will load a previously saved project. The Open Project dialogue box will appear, locate the file to be opened and click on Open. Configuration Files are saved with the *.ffc extension.

Re-Open (Project): Re-Open loads a previously saved project. A list of the 10 most recent projects will appear, from this list select the file to be opened. Configuration Files are saved with the .ffc extension.

Open Automatic Backup: This opens a file that has automatically been saved by ConfigManager.

Save: Saves a file as a named file. The project name is usually the preferred option.

Save File As: Saves a file as an alternatively named file.

Close Project: Closes the Project after prompting Yes / No, Cancel to save.

Print: To print the network point and double click on the Node and follow the prompts.

Exit: To close down the Configuration Manager program select Exit. If changes have been made to the current project and have not been saved then a drop down box will appear asking the operator if they wish to save the file now.

3.2 Connect

3.2.1 Connect to *FireFinder Series II*

This will bring up a terminal window showing communications to and from the *FireFinder Series II*. Refer to the programming section at the end of this manual for more information.

3.3 Tools

3.3.1 Verify Project (F4)

The verify function will verify there are no errors or omissions in the project.

3.3.2 Compile File (F5)

The compile file must be done every time that a modified file is to be downloaded to the *FireFinder Series II* panel. This ensures that the data format is correct as per the required structures.

3.3.3 Convert File from *FireFinder Series II* System

This will convert the information previously uploaded from the *FireFinder Series II* FACP into a format such that it can be imported for use by Config Manager. (*.fcc)

3.3.4 Clean Up Directory

The clean up directory function will automatically erase unnecessary files that have been created during the compile process.

3.4 Options

3.4.1 Environment Settings

Clicking on this option will display the Environment Settings Options Dialogue Box as seen below.

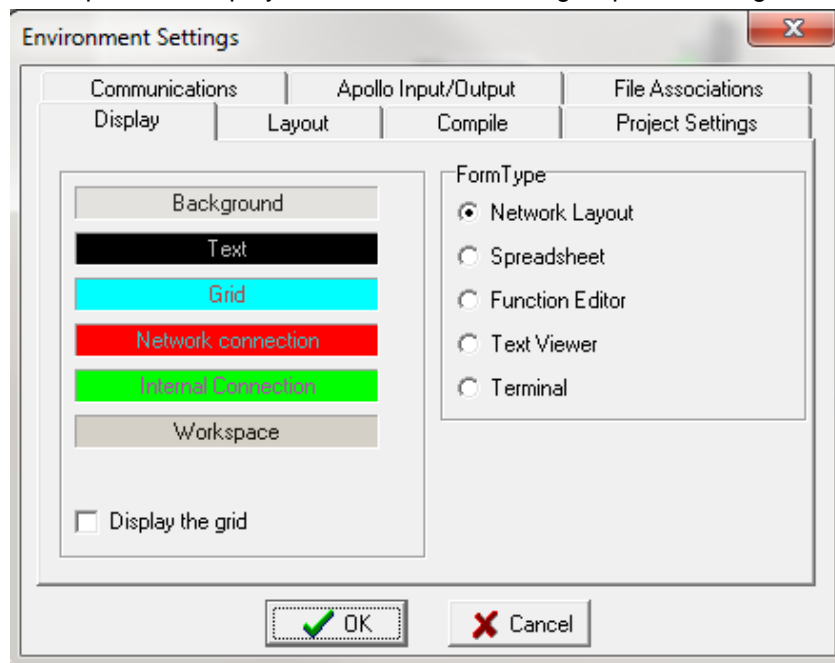

Figure 2: The Environment Settings Options Dialogue Box

From this dialogue box the following features to be set are:

3.4.1.1 Colours:

The colour of the various elements in the program can be set by selecting this tab.

For each Form Type indicated on the right hand side simply click on the indicator and the colours selected will be shown on the left hand side. To modify these colours click on the colour and a colour selection chart will appear. Select the preferred colour, and press OK on the form.

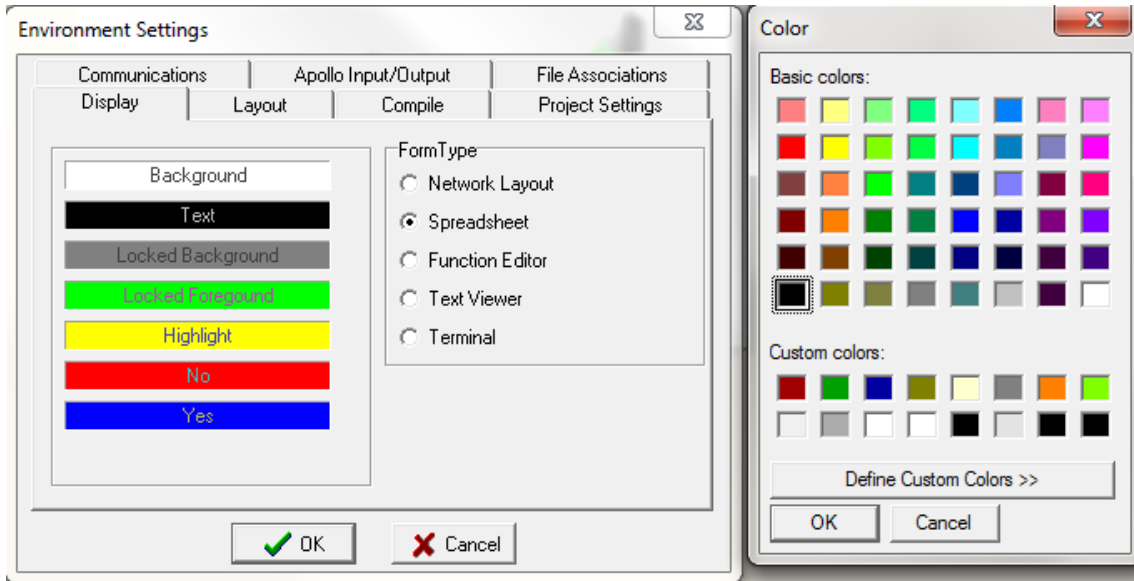

Figure 3: The Environment Settings Dialog Box

3.4.1.2 Layout:

This option sets the format of the screen at start up.

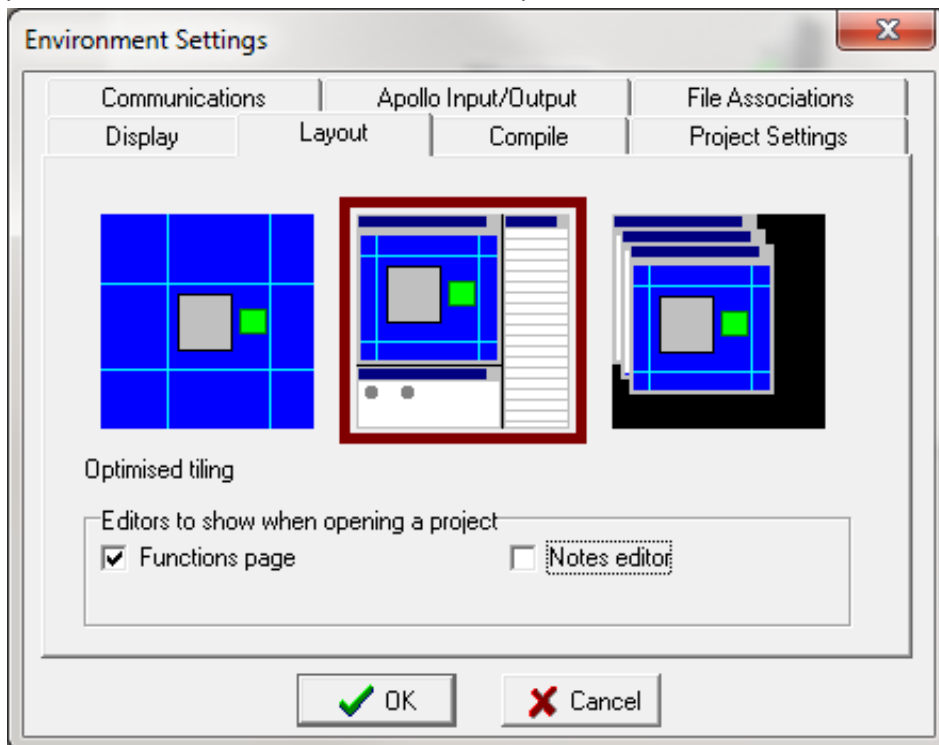

Figure 4: Layout Dialogue Box

3.4.1.3 Compile:

Set options to display the compiled file and to choose whether to validate included text as functions. In most instances these will both be set to be on.

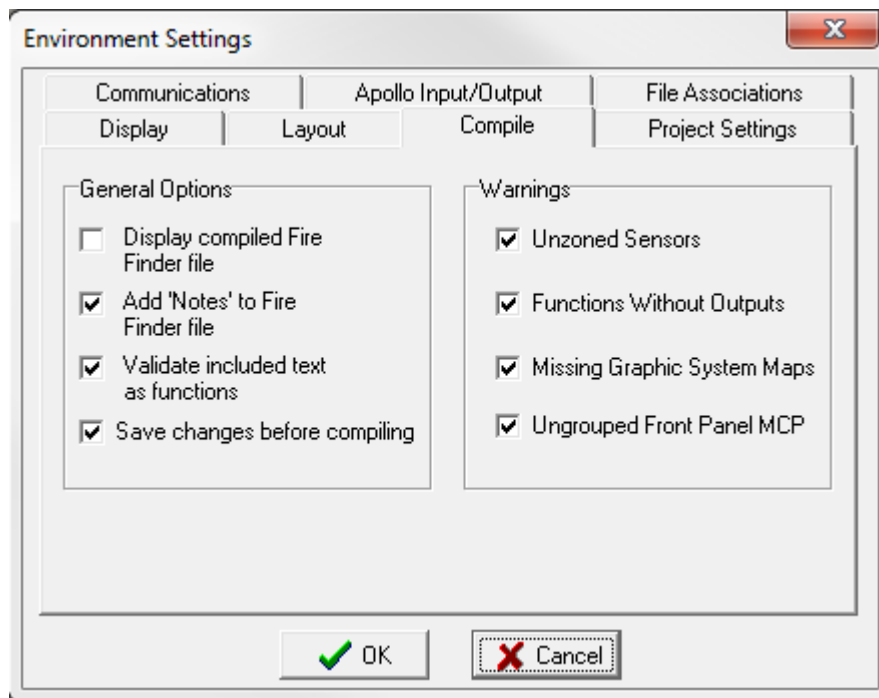

Figure 5: Compile Dialogue Box

Display Compile File: Selecting this tab option will display the compiled *FireFinder Series II* file. This means that, after compiling the project the *.dat file is displayed in a window on the screen. *This is mainly for the advanced user and is usually not selected.*

Add 'Notes' to FireFinder Series II File: Allows notes to be added to the file.

Validate Included Text as Functions: This feature is used when SPECIAL functions are included in a project. SPECIAL functions are functions that are written in text form and included in the project in the INCLUDED file.

Save Changes Before Compiling: Automatically saves any changes before compiling.

Warnings: A warning will be indicated during the Compiling process that the checked features do not meet the required criteria and must be corrected.

- Un-zoned Sensors
- Functions Without Outputs
- Missing Graphic System Maps
- Ungrouped Front Panel MCP

3.4.1.4 Project Creation:

Here 2 lines of default customer text (e.g. name) can be entered. This saves having to enter the company's name for every configuration.

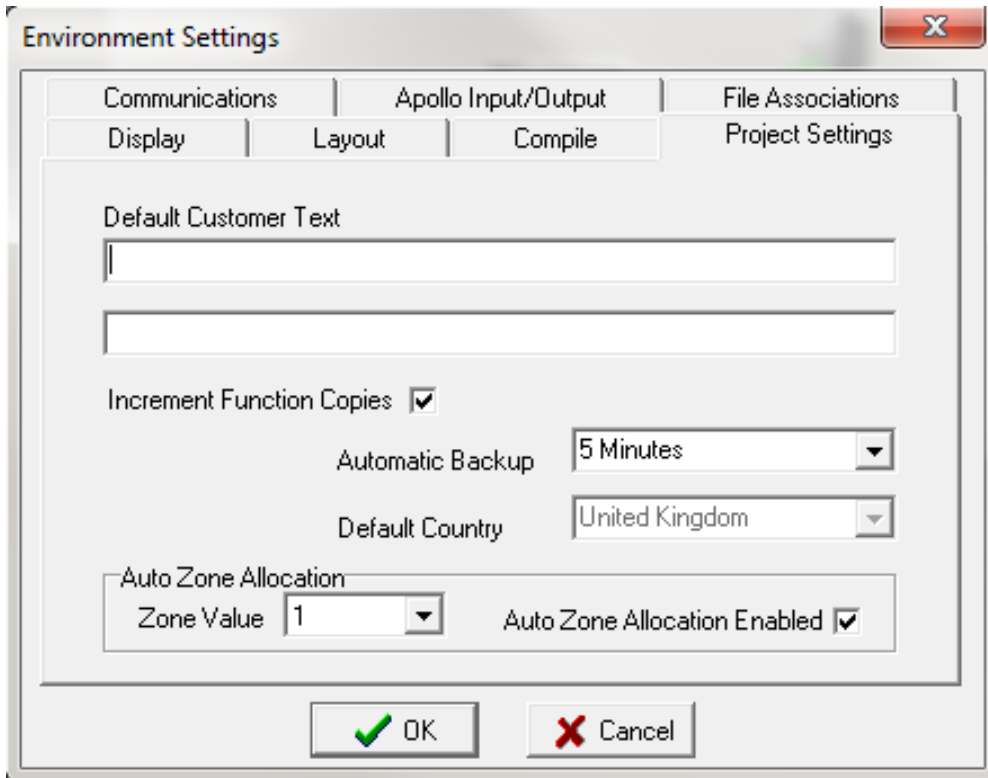

The image shows a dialog box titled "Environment Settings" with a close button (X) in the top right corner. The dialog has several tabs: "Communications", "Apollo Input/Output", "File Associations", "Display", "Layout", "Compile", and "Project Settings". The "Project Settings" tab is selected. Inside the dialog, there are two text input fields for "Default Customer Text". Below these fields, there is a checked checkbox for "Increment Function Copies". To the right of this checkbox are two dropdown menus: "Automatic Backup" set to "5 Minutes" and "Default Country" set to "United Kingdom". At the bottom of the dialog, there is a section for "Auto Zone Allocation" with a "Zone Value" dropdown set to "1" and a checked checkbox for "Auto Zone Allocation Enabled". At the very bottom of the dialog are "OK" and "Cancel" buttons.

Figure 6: Project Creation Dialogue Box

Increment Function Copies: Click on the tick box to enable

Automatic Backup: Select the timing for automatic periodic backup of the project from the drop down box (5, 15, 30, 45, 60 minutes or NEVER).

Default Country: Set to the country where the panel is to be installed from the drop down box.

Auto Zone Allocation Enabled: Click on the tick box to enable

Auto Zone Allocation Value: Open the drop down box to select a value (0-999).

3.4.1.5 Communications:

This tab will display a page to set the port and methodology used to communicate with the *FireFinder Series II*. Normally;

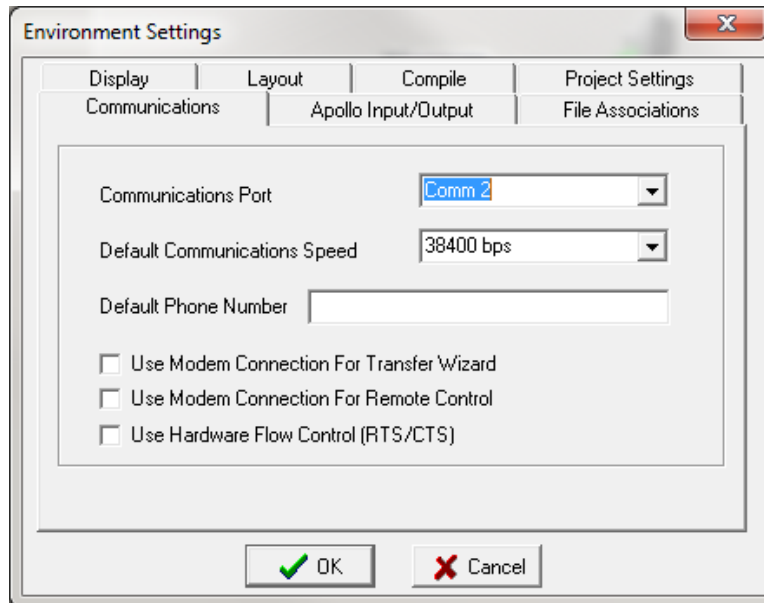

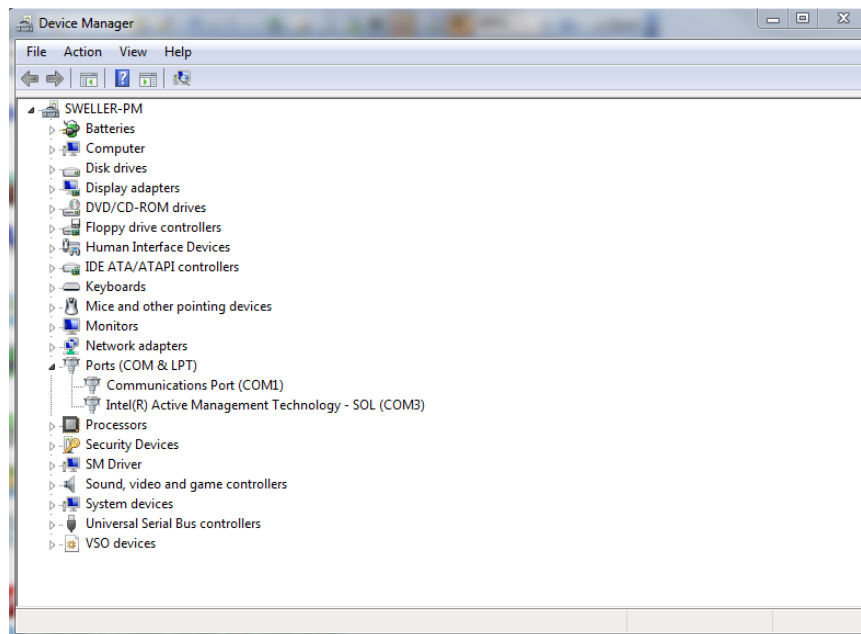

Figure 7: Communication Dialogue Box

USB: A converter is required

Communications Port: Comms 1-8

 **Note:** Available Ports can be found by using Device Manager within the Window operating system



Default Communications Speed: The speed or baud rate of the communications port is configured for 38,400 bps to talk to the *FireFinder Series II*TM and no adjustments are required by the user.

Default Phone Number: Enter the phone number to be auto dialed for modem connection

Use Modem Connection for Transfer Wizard: Tick if the Transfer Wizard is to be used as the communication vehicle.

Use Modem Connection for Remote Control: Tick if remote control of the FACP is via the modem

Use Hardware Flow Control (RTS/CTS): Tick if hardware control is used from the transfer of data.

3.4.1.6 File Association:

Tick the check box if the project *.ffc files are to be associated the with ConfigManager United Kingdom. The message displayed on the screen confirms the status

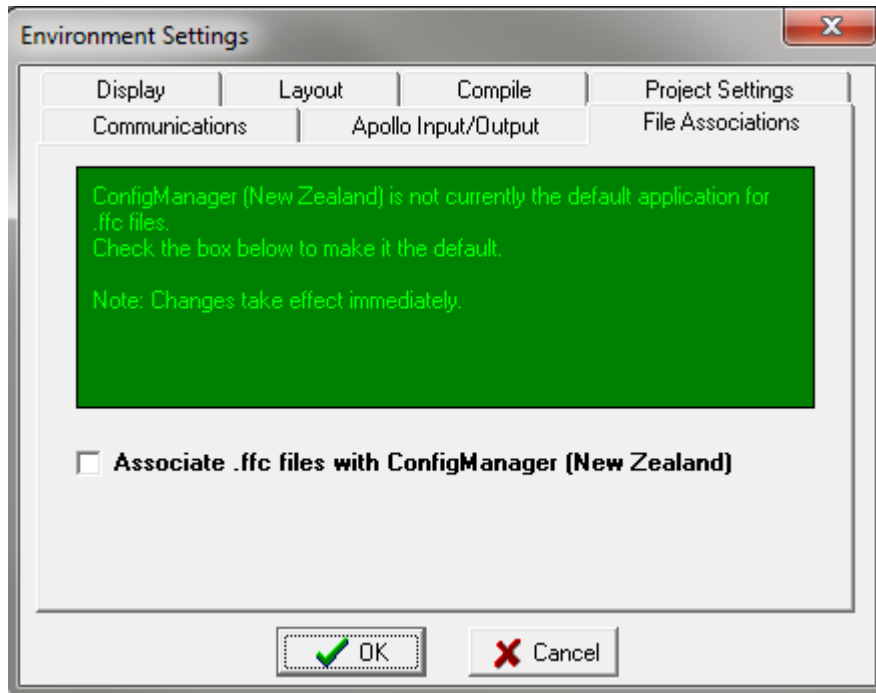

Figure 8: File Association Selection Box

3.4.1.7 Apollo Input/Output

Once the settings 1 through 6 have been set and a new project has been opened (File / New) the Environment Settings screen will now include the **Apollo Input/Output**. This tab enables the inputs/outputs hence functions to be accessed via the front panel menu. Each is simply selected by clicking on the appropriate check box.

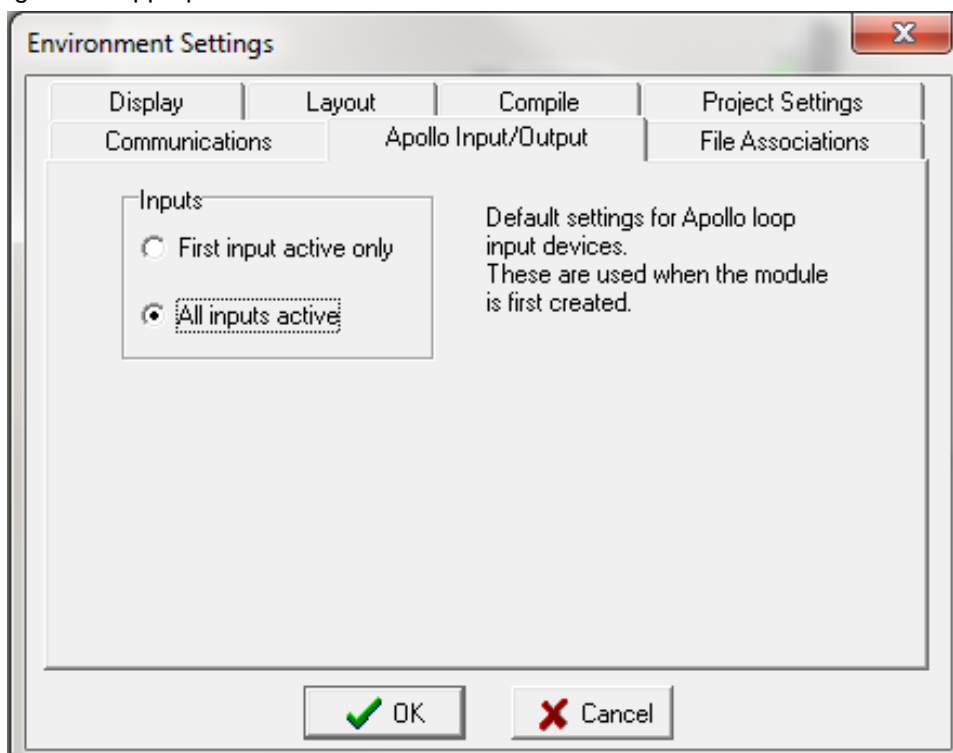

Figure 9: Apollo Input / Output Screen

3.4.2 Window

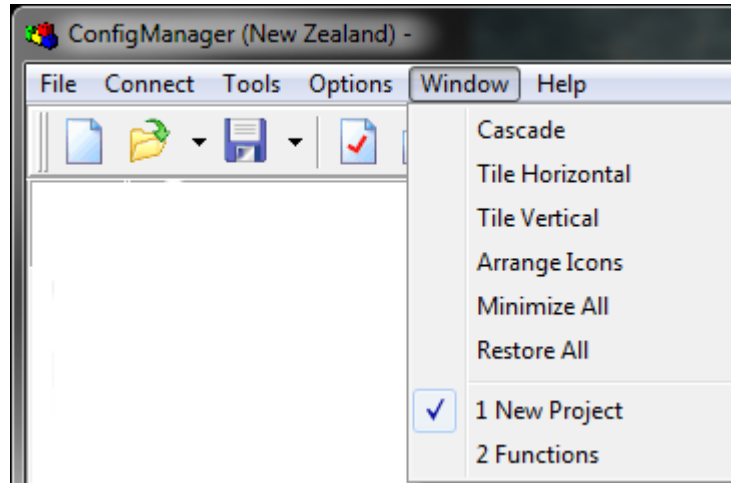

Figure 10: Window Drop Down Box

Cascade: Displays windows stacked and cascading from the top left to the bottom right of the screen.

Tile Horizontal: Displays Project and Function windows top edge to top edge.

Tile Vertical: Displays Project and Function windows right edge to left edge.

Arrange Icons: Arranges minimised image windows within the program screen.

Minimise All: Minimise all active windows to the bottom left hand corner of the screen.

Restore All: Returns all active windows to those selected prior to "Minimise All".

3.4.3 Help

Contents: This is the on screen help file that provides a PDF version of this manual.

About: Displays the following screen giving the user the Version of **ConfigManager** being used, direct access to the Ampac website (highlighted in blue) and communication access (highlighted in blue).



Figure 11: About Screen

4 Creating a New Project

To create a new project either click on the **New Project Icon**  on the tool-bar, **Ctrl + N** or;

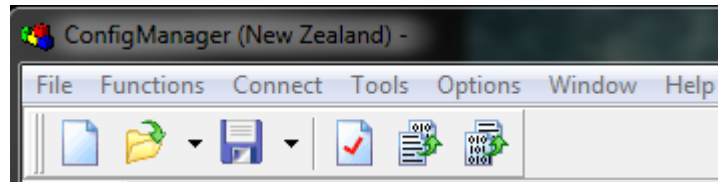



Figure 12: Selecting a New Project

Select: **File/ New Project**. This will bring up the System settings dialogue box as shown below.

 **Note:** Remember the Options / Environmental Settings MUST be entered before starting a new project.

4.1 The Systems Settings Dialogue Box

4.1.1 Base Settings

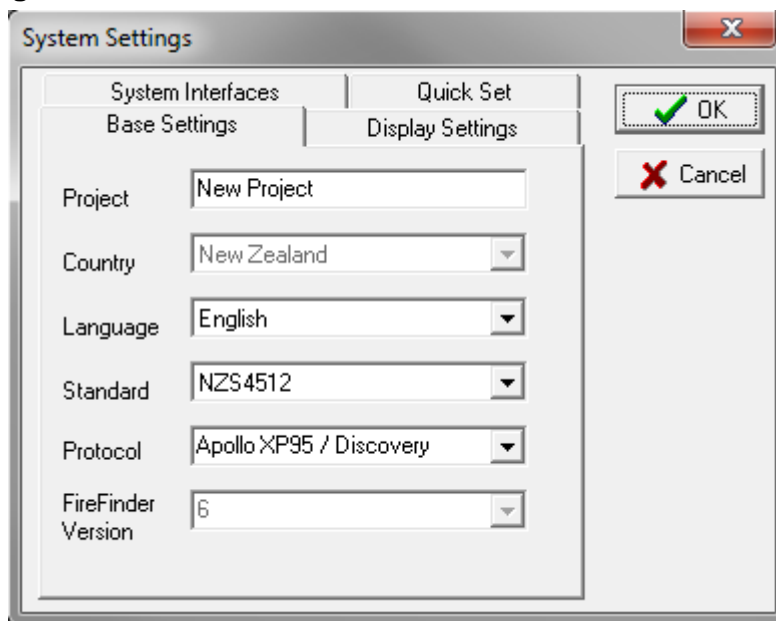

Figure 13: The System Settings Dialogue Box

Enter all the information described in the sub-headings. Once completed press **OK**. If there are any errors the operator will be prompted to correct them.

Project: Enter the project name. Naming is optional though it is advisable to make projects distinctive so they are easily identifiable at a later date.

Country: Preset to New Zealand (not editable)

Standard: Preset to NZS4512 (not editable)

Language: Preset to English (not editable)

Protocol: Preset to Apollo XP95 / Discovery (not editable)

FireFinder Version: Displays the application version of software currently in use.

4.1.2 Display settings

The display settings, sets the LCD message that will be displayed when the *FireFinder Series II* LCD is in its normal state. The text on each line may be up to 40 characters long.

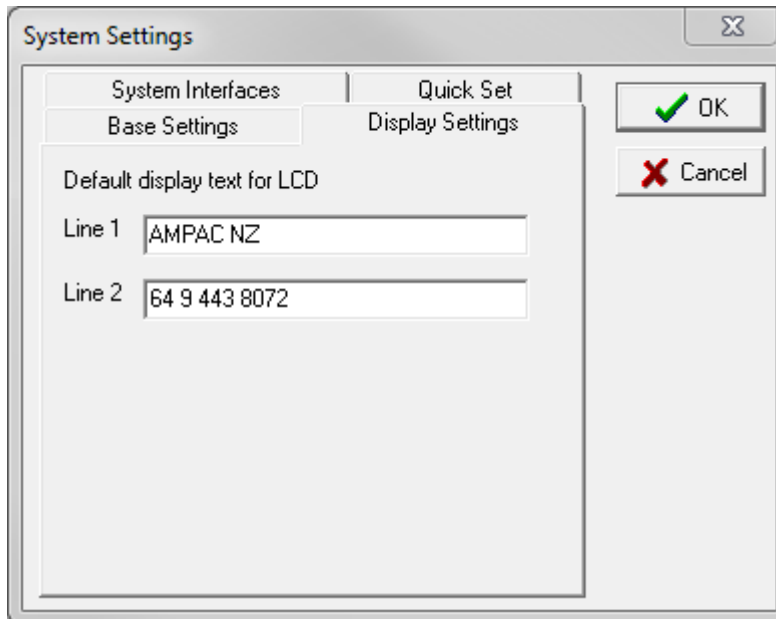

Figure 14: The Display Settings Dialogue Box

4.1.3 Quick Set settings

This option will save a considerable amount of work as it will automatically set up the required number of panels, DGP's and / or mimics.

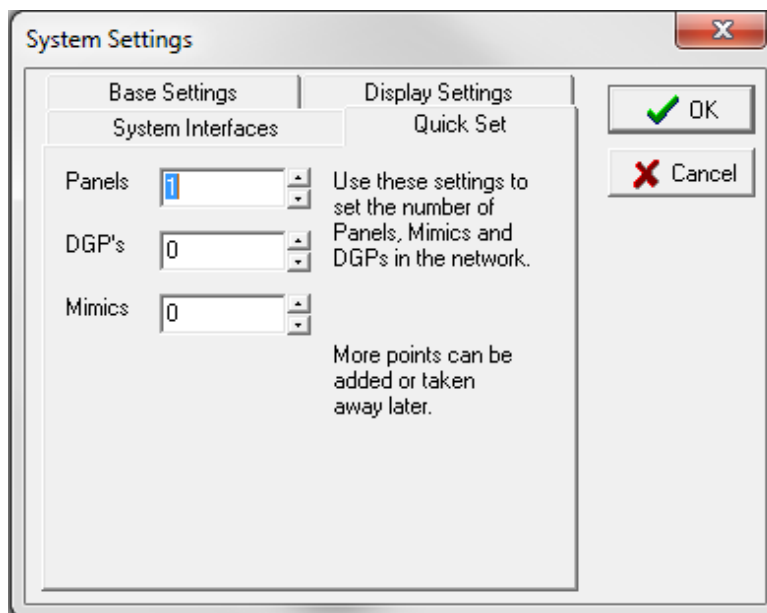

Figure 15: The Quick Set Dialogue Box

Panels: This sets the number of panels in the system. For non-network projects this will be set to one (1).

DGP's: Data Gathering Points (DGP's). This entry is used if DGP's are configured on a network. DGP's being a Slave FACP that, has no front panel controls, communicates directly with and is under the control of the Master FACP.

Mimics: This entry is used if LCD Mimics are configured on a network.

4.1.4 System (SmartGraphics) Interface

The check box is selected if a **SmartGraphics** Interface is fitted to the system. “Map” allocation can be added later once the interface is selected

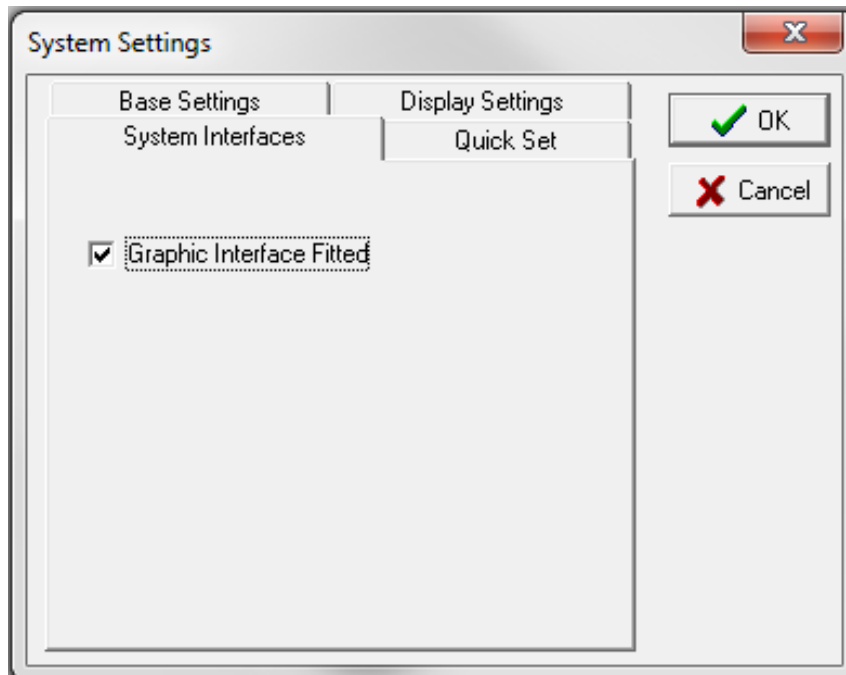

Figure 16: The Quick Set Dialogue Box

4.2 The New Project Screen

When all of the options above have been determined and the OK button has been clicked the following screen will be displayed. This may vary depending on the options selected in the layout options dialogue box. Each of these areas will be discussed in detail on the following pages.

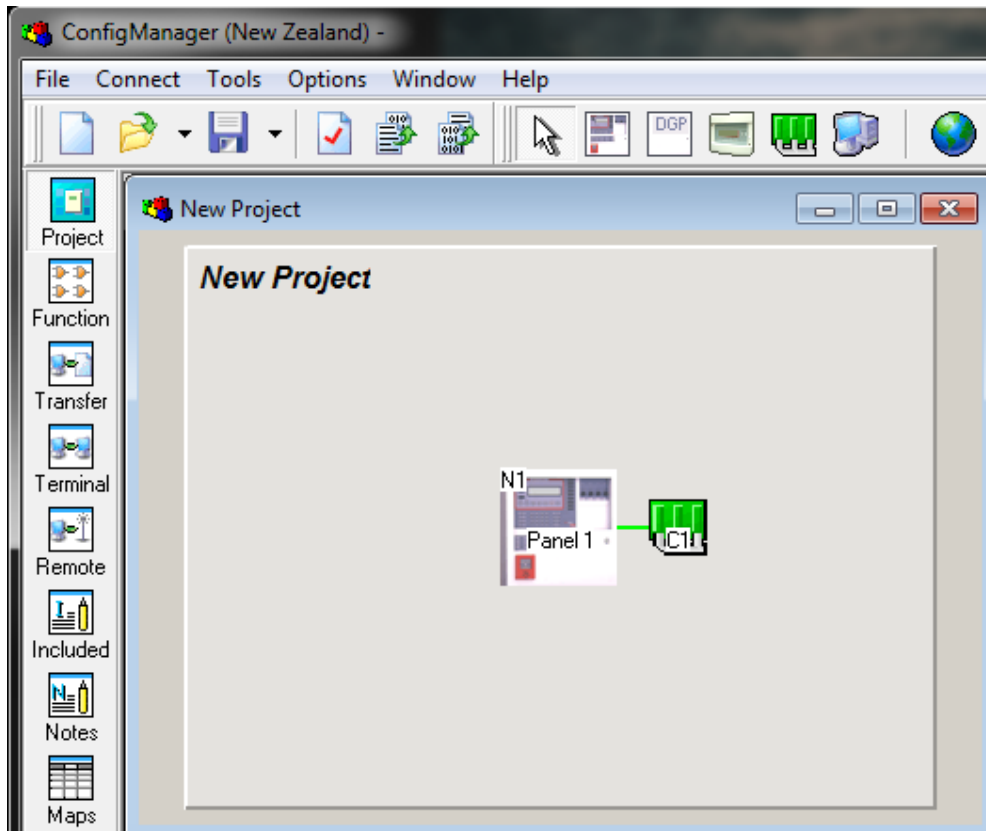

Figure 17: New Project Screen

4.3 The Project View

The screen below is a typical view that will be seen by the operator when a single panel is to be programmed. The Panel represents the hardware which is common in all panels. C1 represents the controller that interfaces with up to 8 slave modules.

 **Note:** It is recommended that the panel section is programmed first followed by the controller.

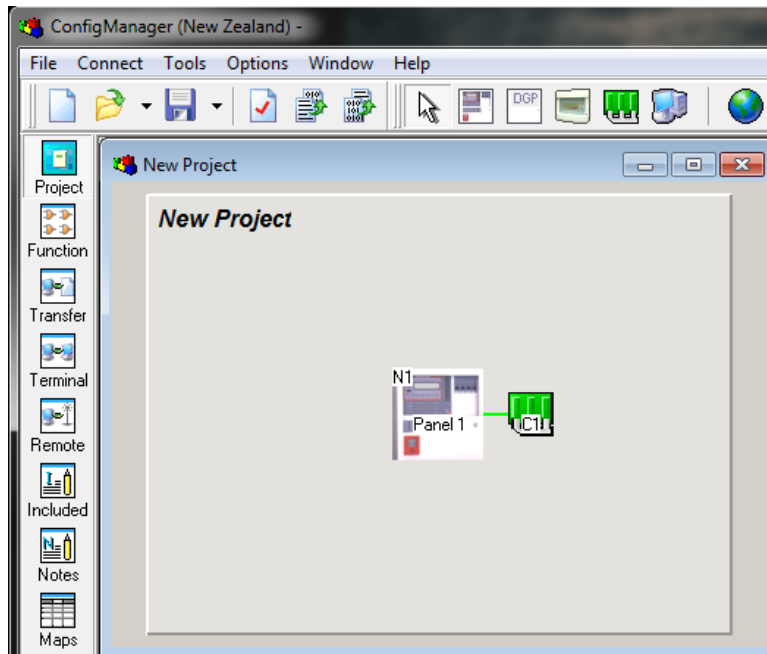

Figure 18: The Project View

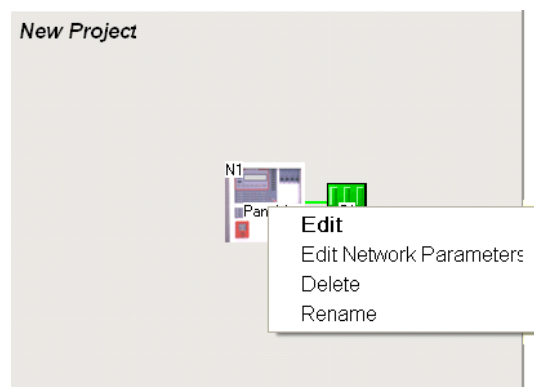

Figure 19: Edit Options for the Panel

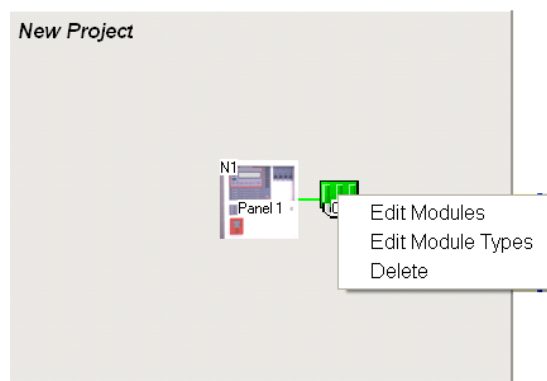

Figure 20: Edit Options for the Controller

It is possible to edit the parameters of the panel by right clicking on the icon as shown above. Similarly it is possible to edit the module types as shown.

4.4 Panel Settings or Editing

Double click on the Panel to set or edit the Panel configuration, Main Information, Brigade Signalling Board, Call point / DBA and the Bell Sounder Boards.



Note: Click on OK to go to or return to the main project screen at any time.

4.4.1 Main Information

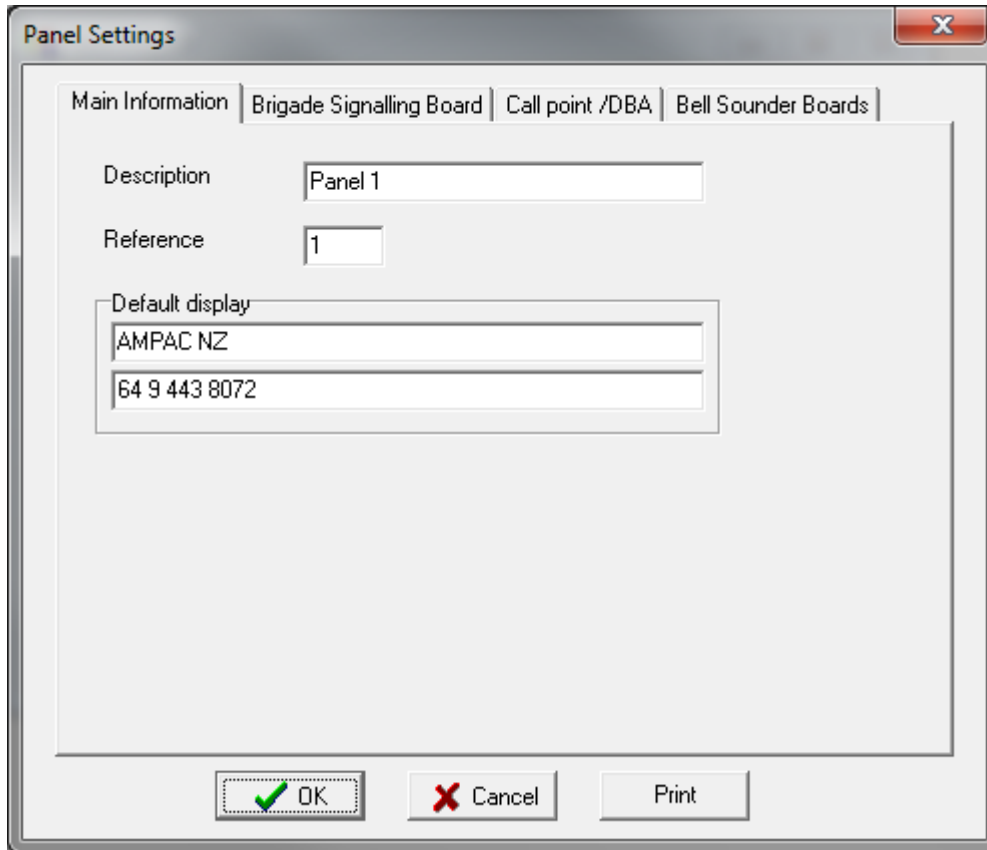

The screenshot shows a dialog box titled "Panel Settings" with a close button (X) in the top right corner. The dialog has four tabs: "Main Information", "Brigade Signalling Board", "Call point /DBA", and "Bell Sounder Boards". The "Main Information" tab is selected. It contains the following fields:

- Description: A text box containing "Panel 1".
- Reference: A text box containing "1".
- Default display: A group box containing two text boxes. The top one contains "AMPAC NZ" and the bottom one contains "64 9 443 8072".

At the bottom of the dialog are three buttons: "OK" (with a green checkmark icon), "Cancel" (with a red X icon), and "Print".

Figure 21: Panels Settings - Main Information

Description: Default is Panel 1. This can be changed to a more apt description by simply deleting the text Panel 1 and typing a new description. This description will appear next to the panel in the "Project" screen

Reference: Node number (Networking). (Default is 1)

Default Display: Type in the preferred FACP LCD front panel default information. (Default empty)

4.4.2 Brigade Signaling Board

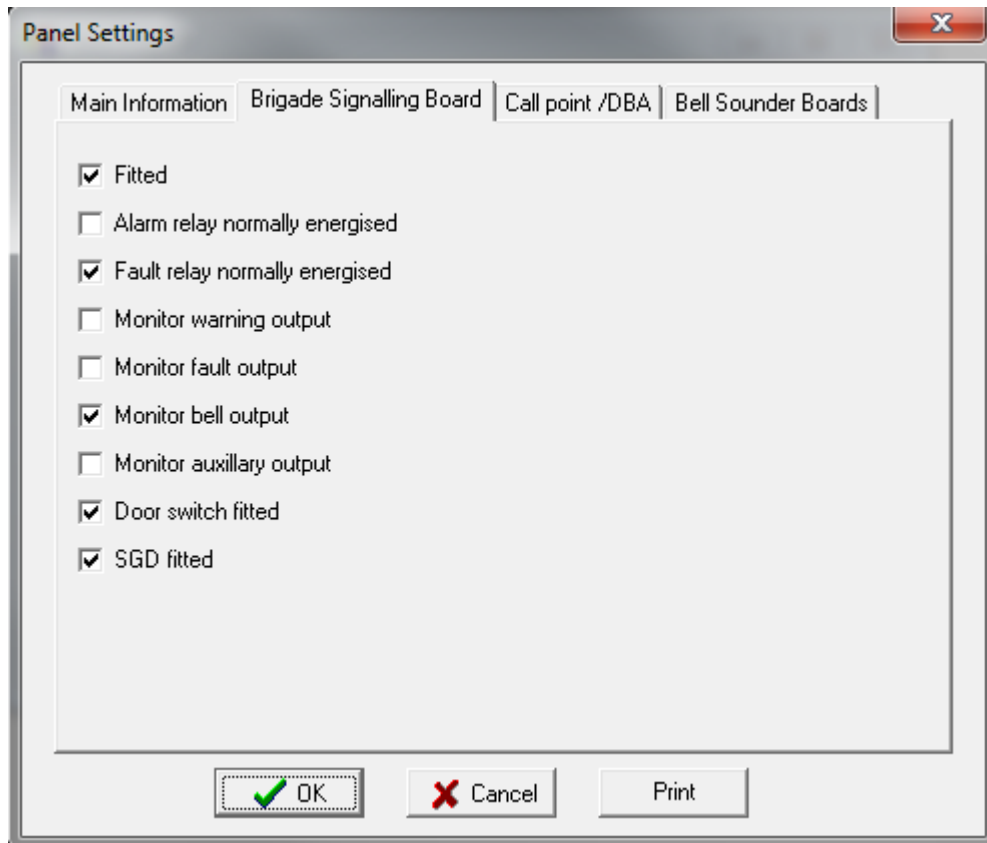

Figure 22: Panels Settings - Brigade Signaling Board

Fitted: Click on the box (ticked) if the board is fitted. (Default selected)

Alarm relay normally energised: If the relay is to be normally energised click on the check box (ticked). (Default not selected)

Fault Relay normally energised: If the relay is to be normally energised click on the check box (ticked). (Default selected)

Monitor Warning output: If ticked Monitor this O/P. (Default not selected)

Monitor Fault O/P: If ticked Monitor this O/P. (Default not selected)

Monitor Bell O/P: If ticked Monitor this O/P. (Default selected)

Monitor Auxiliary O/P: Click on the check box (ticked) if O/P is to be monitored. (Default not selected)

Door Switch Fitted: Ticked if Door Switch fitted (Default Selected)

SGD Fitted: Ticked if a Signal Generating Device is Fitted (Default Selected)

4.4.3 Call Point / DBA

Shown is the Manual Call Point selected screen. By default the MCP is OFF

 **Note:** (For information only NOT USED IN EN54 PANELS)

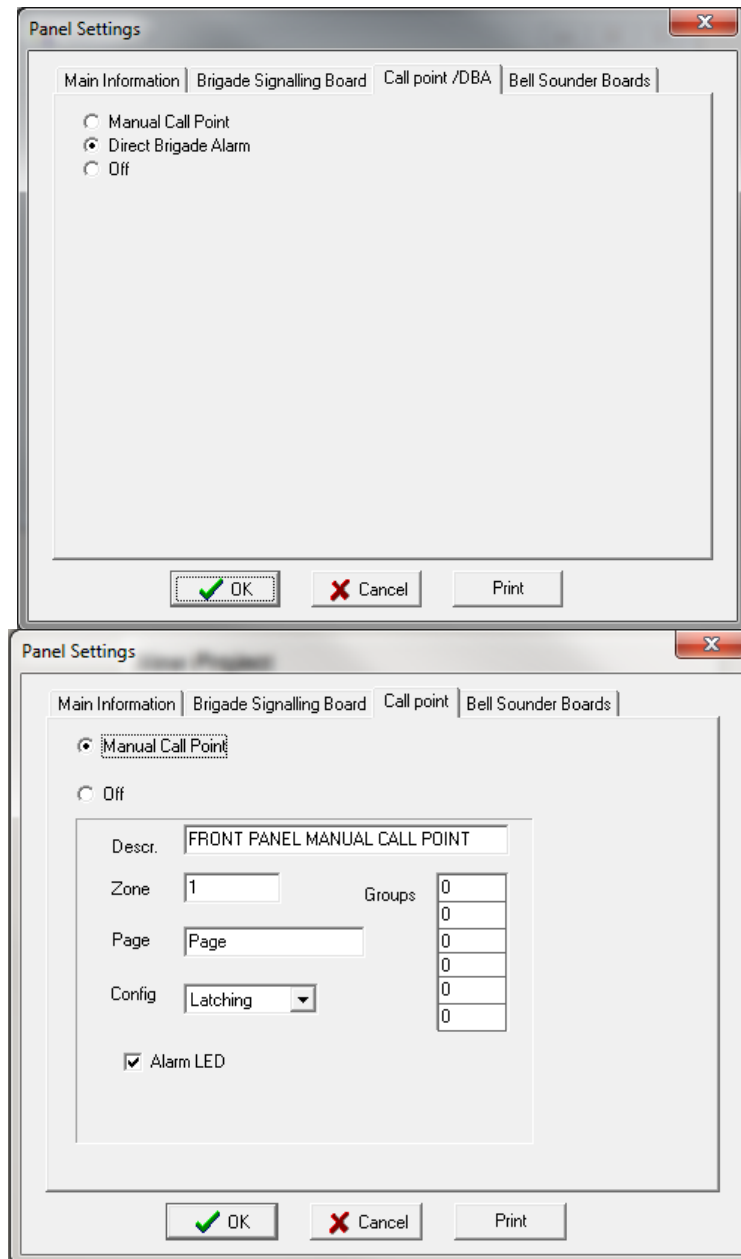

Figure 23: Panels Settings - Call Point / DBA

Manual Call Point: Click on the check box (ticked) to enable the MCP. (Default OFF)

OFF: Click to disable the selection. (Default)

Desc: Type in a name or description / location of the MCP. (Default "FRONT PANEL MANUAL CALL POINT")

Zone: Allocate the Zone that the MCP will be associated with. (Default = 1)

Page: Displays the "page" in **SmartGraphics** that the MCP will appear on. (Default not shown unless **SmartGraphics** have been added to the system)

Groups: Enter the Group/s to be coupled to the MCP. (Default = 0)

Config: Sets the operation of the MCP to "Latching" or "Non-latching". (Default = Latching)

Alarm LED: Check (tick) if the MCP is to operate that output / LED. (Default selected)

4.4.4 Bell Sounder Boards

This option allows the user to select a number of Bell/Sounder output boards to be fitted to the panel. These boards allow a larger number than normal, of bells and sounders to be connected to the **FireFinder Series II** System. In the Bell Sounder Board screen the type of Sounder Board is selected and Sounder Groups are entered into the O/P columns.

Bell Sounder Boards are built in two versions:

1. All outputs are monitored sounder outputs which provide 1 Amp per output.
2. The first 4 outputs are voltage free change over contacts and the second 4 provide monitored 1 Amp outputs.

The Sounder/ Bell monitor board connects to the serial peripheral interface (SPI) bus. This is the same bus that connects to the Brigade Signalling Board. A maximum of 8 boards can be daisy chained together.

Selecting the tick box will determine if the boards are fitted and then selecting either 8SND (sounder / bell) or 4S (bell) / 4VFC (Voltage Free Contacts) will determine which board is to be fitted to the panel.

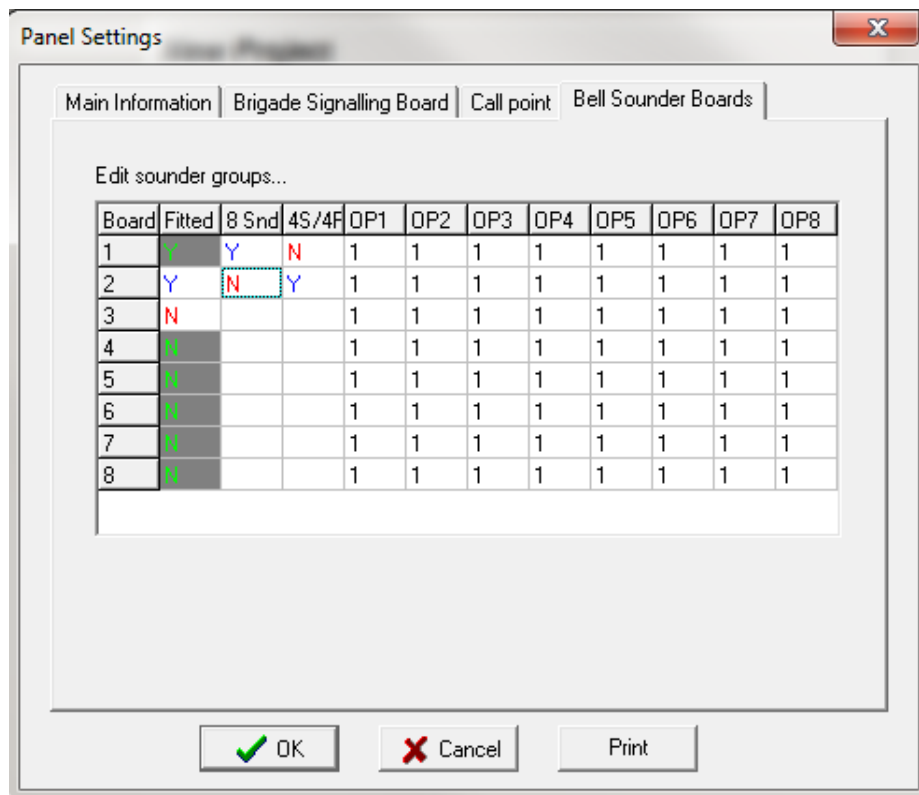

Figure 24: Panels Settings - Bell Sounder Boards

Board Column: 1 – 8 indicates the number of the board and the maximum number of boards that can be fitted.

Fitted Column: Double click on Y (Yes) or N (No) to change the status.

8Snd & 4S/4R Columns: Double click on Y or N to change the fitted not fitted status of the 8 Way Sounder Board. Note if the sounder board is checked the 4Way Sounder / 4 Way Relay option defaults to N (No).

4.5 Network Parameters:

Right click the Panel Icon and select Edit Network Parameters to set Global Access or access for the Panel, Loops and / or Groups.

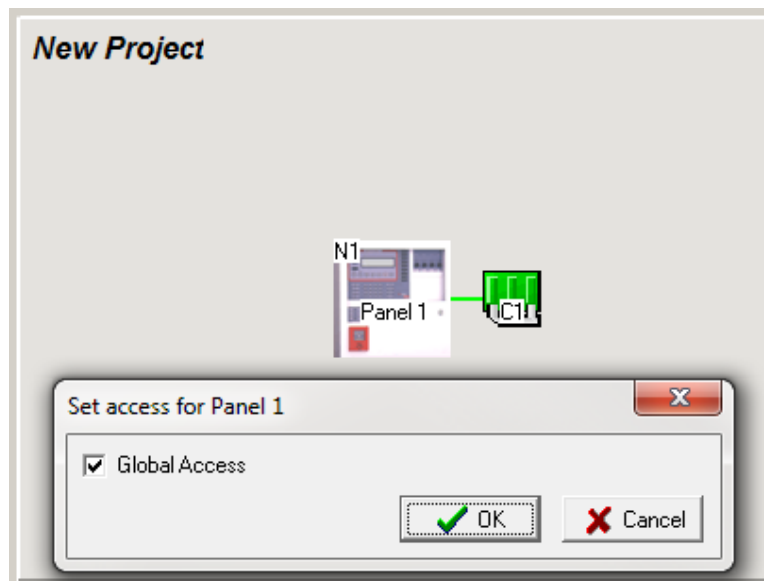
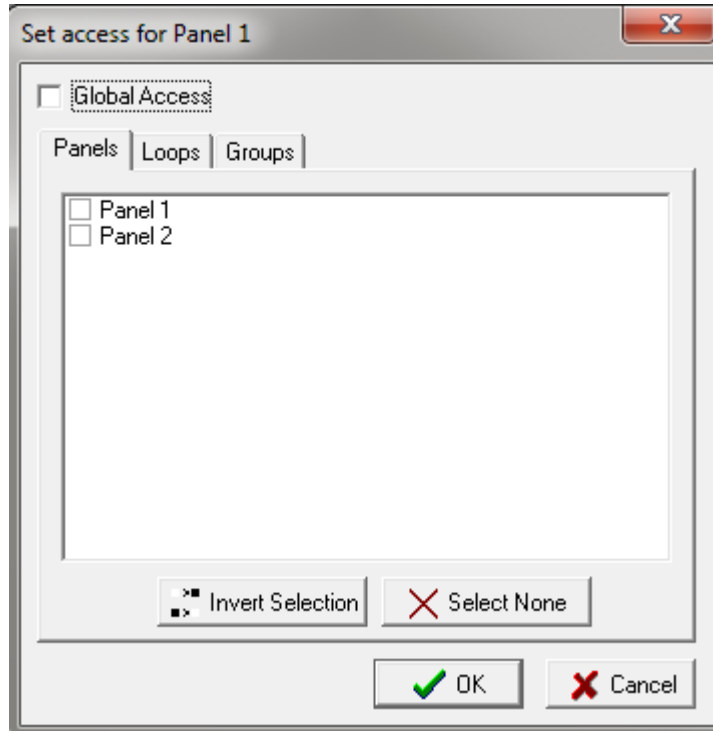

Figure 25: The Panel Access or Network Parameters Screens

If Global Access is assigned to a Panel, DGP or mimic they will see or monitor the entire system. If it is not set then the various panels, Loop/s and Group/s will have to be assigned by way of the Set Access screen. In other words the panels Loop/s and or Group/s that a Panel, DGP and / or Mimic will see or monitor must be individually entered.

4.6 Controller Configuration

4.6.1 Setting or Editing the Controller Module Types:

Right click on the Controller and select “Edit Module Types” from the drop down screen. Using the “Classic” screen click the down arrow within the “Type” column to display the drop down box from which the module type is selected by clicking on it. The Description and Ref [Reference] No [Number] is automatically assigned. Alternatively the “Graphic” screen can be used. This screen uses the click and drag method where the module type from the top of the screen is clicked on and dragged to the required position 1 to 8.

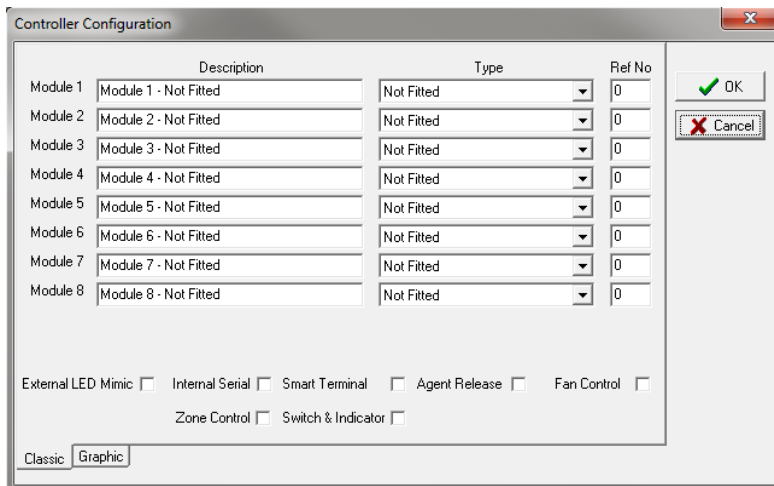

Figure 26: The Controller Configuration Classic Edit Screen

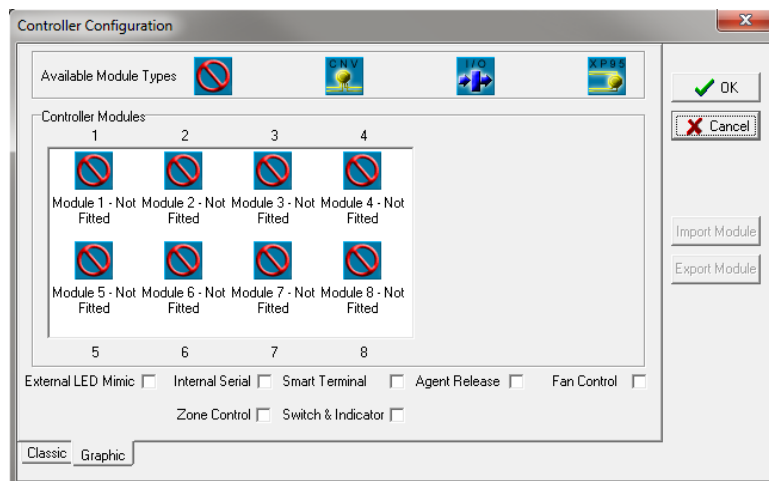

Figure 27: The Controller C1 Edit Module Types Classic and Graphic Screens

4.6.2 Rearranging Module Order

Method 1: Select *Graphic* then click and drag each Module into the required order.

Method 2: Select *Classic*. Save and Import the modules to be rearranged. This is done by changing the *Type* to *Not Fitted* and selecting *OK*, the drop down screen shown below will appear, click *Yes*, then *Save* to a preferred file location. To reapply or Import a Module select the Controller Configuration option *Graphic*, select the available Module number then *Import Module*, repeating the process in the desired order for each Module.

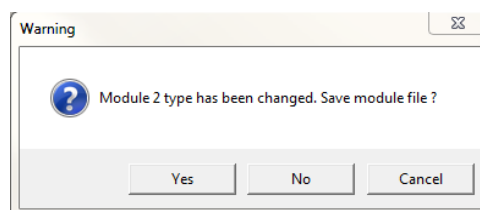

Figure 28: Warning Pop up Box

4.6.3 Controller Setting or Editing

i The following screens have been compressed for the purposes of explanation

Edit Modules Apollo and Conventional: To physically edit each parameter left click in the appropriate square and enter or change the existing setting / information.

i Both drop down screens are shown displayed, this is for explanation purposes only.

Sens.	More	Zone	Description	Type	Type Descr.	Zone Cnfg	Time Out	AIF	Rem Asc	Alm LED	G	R	O	U	P	S
1				Not Fitted		Normal	0	N	Y	Y						
2				Not Fitted		Normal	0	N	Y	Y						
3				XP95 Photo Optical		AVF	0	N	Y	Y						
4				XP95 Thermal Std		Self Reset	0	N	Y	Y						
5				XP95 Thermal High		Non Latching	0	N	Y	Y						
6				XP95 Ionisation		General Purpose	0	N	Y	Y						
7				XP95 Manual Call Point		Investigation Alarm	0	N	Y	Y						
8				XP95 Multi Sensor		Normal	0	N	Y	Y						
9				XP95 Input / Output		Normal	0	N	Y	Y						
10						Normal	0	N	Y	Y						
11						Normal	0	N	Y	Y						
12						Normal	0	N	Y	Y						
13						Normal	0	N	Y	Y						
14						Normal	0	N	Y	Y						
15						Normal	0	N	Y	Y						
16						Normal	0	N	Y	Y						
17						Normal	0	N	Y	Y						
18						Normal	0	N	Y	Y						
19						Normal	0	N	Y	Y						

Figure 29: Controller Settings - Apollo Loop Module

Cct	Zone	Description	Type	Type Descr.	Zone Cnfg	Time Out	AIF	Alm LED	G	R	O	U	P	S
1	1		Normal		Normal	0	N	Y						
2	2		Normal		Normal	0	N	Y						
3	3		Normal		AVF	0	N	Y						
4	4		Normal		Self Reset	0	N	Y						
5	5		Normal		Non Latching	0	N	Y						
6	6		Normal		Normal	0	N	Y						
7	7		Normal		Normal	0	N	Y						
8	8		Normal		Normal	0	N	Y						
9	9		Normal		Normal	0	N	Y						
10	10		Normal		Normal	0	N	Y						
11	11		Normal		Normal	0	N	Y						
12	12		Normal		Normal	0	N	Y						
13	13		Normal		Normal	0	N	Y						
14	14		Normal		Normal	0	N	Y						
15	15		Normal		Normal	0	N	Y						
16	16		Normal		Normal	0	N	Y						

Figure 30: Controller Settings - Conventional Module

Edit Module Input / Output: Here the Input and Output descriptions can be edited and the Inputs and Outputs can be made active / inactive. To physically edit the description click in the box and edit from the keyboard in the normal way. To set an Input or Output to active / inactive double click on the “Y” [Yes] active or “N” [No] inactive.

I/O	Input Description	Input Active	Output Description	Output Active
1	Office	Y		Y
2	Reception	Y		Y
3		N		N
4		N		N
5		N		N

Figure 31: Controller Setting - Input / Output Module

4.6.4 Adding More Controllers / Adding More Modules

Adding more Controllers, C2, C3, C4, facilitates the addition of more modules which again have to be set in the Classic or Graphic screens.

Note: *SmartTerminal*, is only available to Controller 1 (C1) in both protocols and will be shown to be shaded out, as seen below, to indicate this.

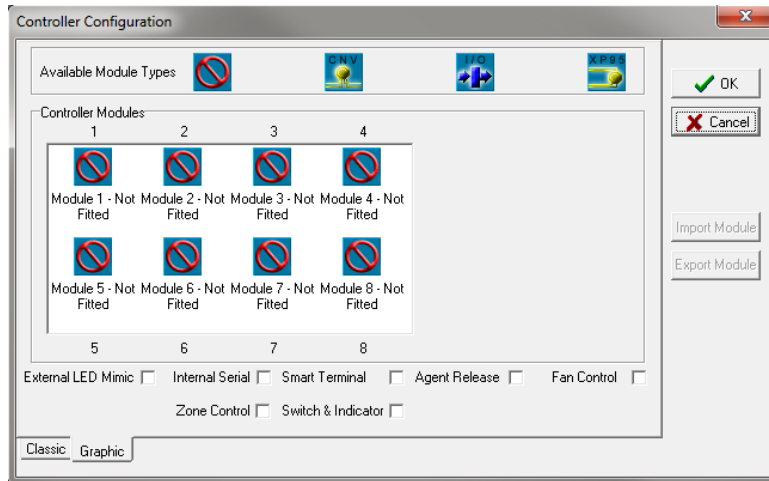

Figure 32: Controller Config C1 Edit Module Types (Graphic Screen)

4.6.5 Edit External LED Mimic.

Click on the “Tab” External LED Mimic and the Edit screen will be displayed.

Description: Click in box and edit the text from the keyboard in the normal way.

Active: Double clicking on the “Y” [Yes] sets the Mimic as active; “N” [No] is inactive.

Double click in the box associated with each LED and the Edit Input selection box will be displayed. This sets the input that will drive the LED or cause it to change state to indicate a system condition e.g. Alarm LED normally “off” is turned on if an alarm is initiated. Click on “Change” to set the criteria

In the screen shown an “Assigned Point” has been set to drive the Common LED’s while a “Zone” has been set for LED’s 1 & 3, a “Group” LED 2, a “LOOP” for LED 4 and a “Panel O/P for LED 5. Click “Change” to set.

LED	Mimic 1	Mimic 2	Mimic 3	Mimic 4	Mimic 5	Mimic 6	Mimic 7	Mimic 8	Mimic 9	Mimic 10	Mimic 11	Mimic 12	Mimic 13	Mimic 14	Description
Active	Y	Y	N	N	N	N	N	N	N	N	N	N	N	N	N
Comm LED 1	Alarm														
Comm LED 2	Pre-Alarm														
Comm LED 3	Fault/Defect														
Comm LED 4	Normal														
Comm LED 5															
G.P. Out	GRP:1														
LED 1	ZN:1														
LED 2	LP:1 SR:1														
LED 3	M:1 IN:1														
LED 4	Alarm														
LED 5	Pre-Alarm														
LED 6	LP:1 AD:1 O:1														
LED 7	M:1 O:1														
LED 8															

Figure 33: The Edit External LED Mimic Screen

Note: The following screens are for demonstration purposes only as only one "Edit Input" selection box will appear at any one time.

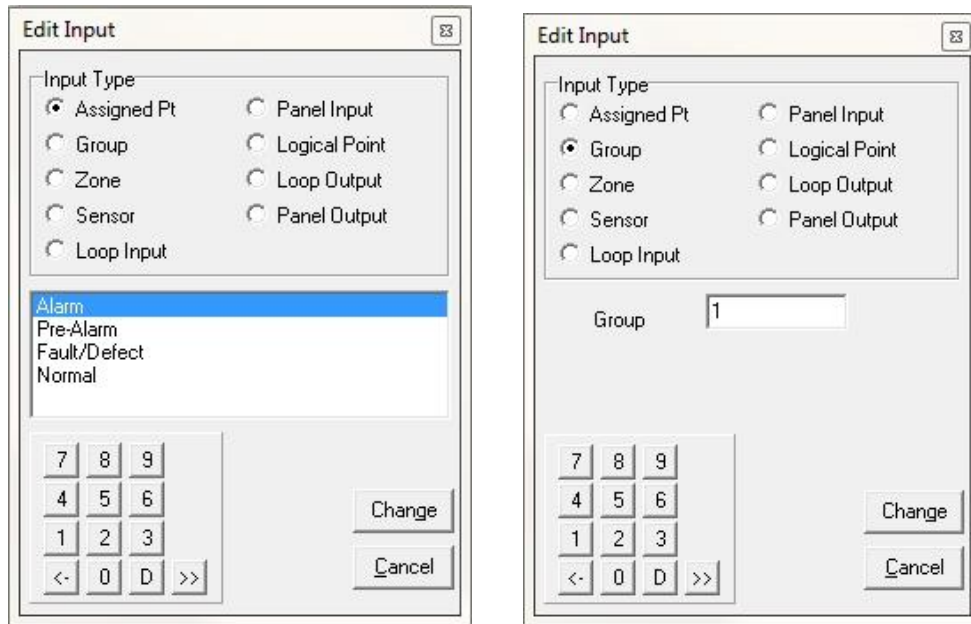

Figure 34: Edit Input - Group Settings and Zone Settings

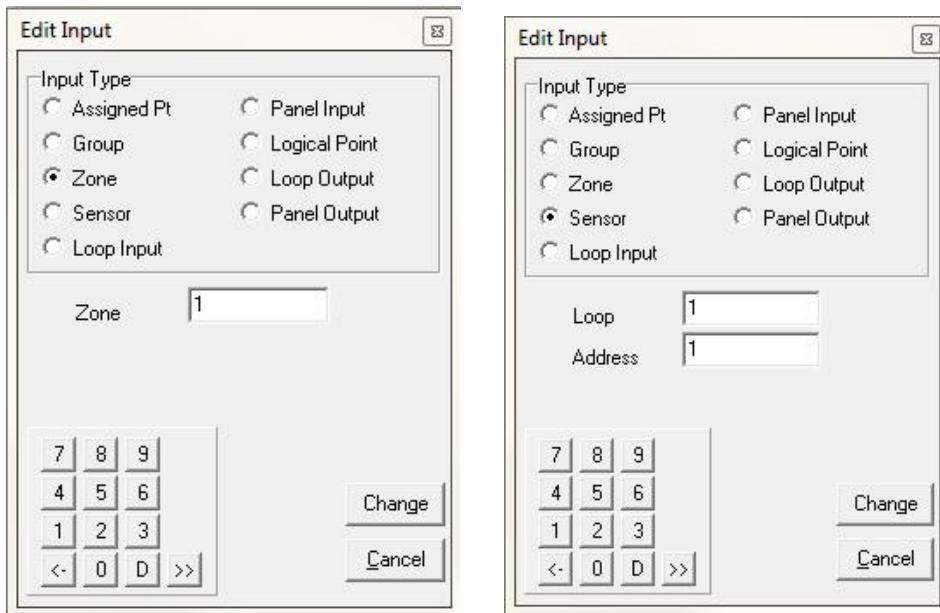

Figure 35: Edit Input - Zone and Sensor



= Numeric keypad for data entry

<- = Delete last or highlighted entry

D = Delete highlighted entry

>> = Highlight entry

4.6.6 Edit Internal Serial

Click on the “Tab” Internal Serial and the Edit screen will be displayed.

Type: Click within the box to access the drop down screen and select the type of board, in the example shown a Relay Board has been selected.

Output: Double click within a box to edit the type of input that will turn the output on.

In the example screen a Relay Board has been assigned

- O/P 1 has been set to be turned on by an Alarm Assigned Point.
- O/P 2 has been set to be turned on by Zone 3
- O/P 3 has been set to be turned on by the Loop I/P Loop 1 Address 12 Input 2.

Again click on “Change” to set the output.

Note: The following screen is for demonstration purposes only as only on 1 drop down box will appear at any one time as will the “Edit Input” selection box. Note also that the SmartTerminal has not been selected in the Controller Edit Module Types screen hence it tab is not displayed at the top of the screen.

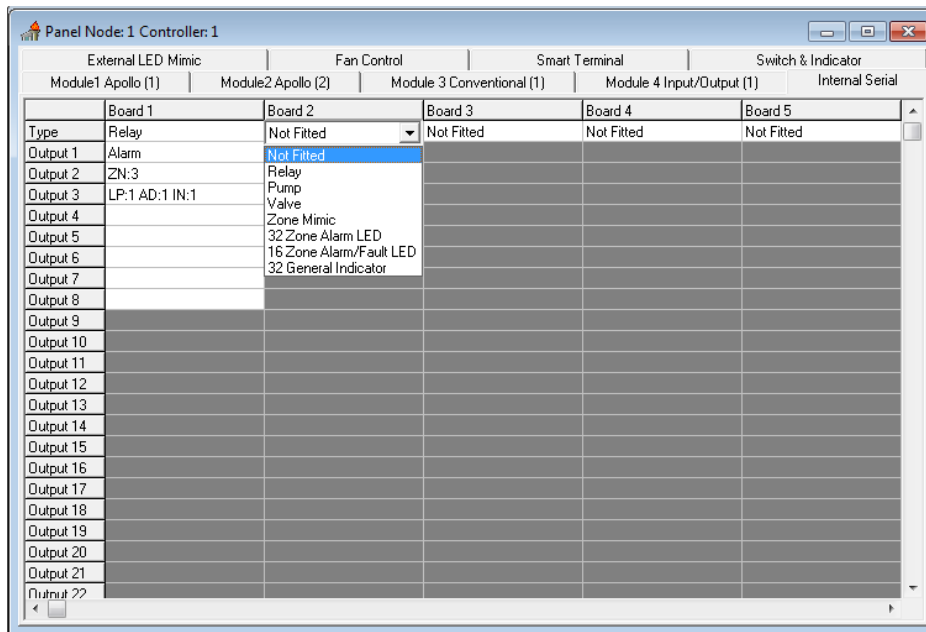

Figure 36: The Edit Internal Serial Screen

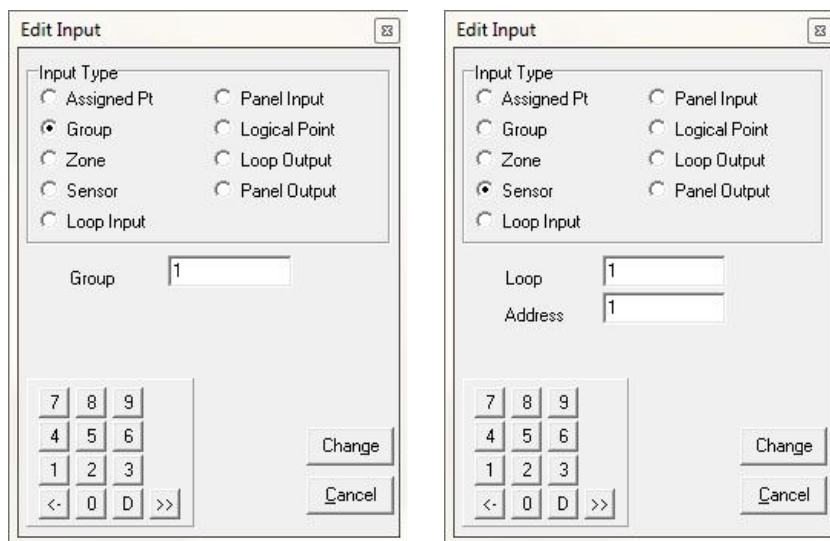

Figure 37: Edit Input - Group Settings and Sensor Settings

4.6.7 Edit Fan Control

Click on the “Tab” Fan Control and the Edit screen will be displayed. Editable fields are:

Master Reset (Enables Master Reset of the Fan Controls)

Latch Reset (

Fitted / Not Fitted (Double click to edit Y = Fitted N = Not fitted)

Description (Double click to enter description)

Termination Card Fitted / Not Fitted (Double click to edit Y = Fitted N = Not fitted)

Fan Set (3 wire, 4 wire or 5 wire systems)

AUX / Latch

Fan Alarm Inputs (Double Click to Edit Fan Alarm Inputs) Note: when the Termination board is fitted this input will be disabled.

Fan Inhibit Inputs (Double Click to Edit Fan Inhibit Inputs) Note: when the Termination board is fitted this input will be disabled

Fan Start / Stop Outputs (Double Click to Edit Fan Inhibit Inputs) Note: when the Termination board is fitted this input will be disabled.

Fan Run / Stop / Fault Indicator Inputs (Double Click to Edit Fan Indicator Inputs) Note: when the Termination board is fitted this input will be disabled.

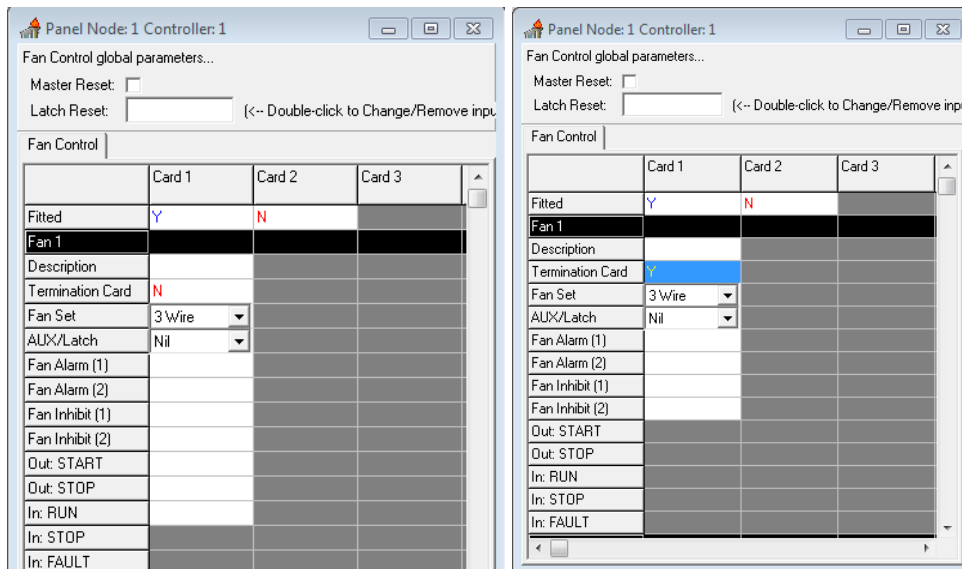

Figure 38: 3 Wire Fan Control Screen with and without Termination board fitted

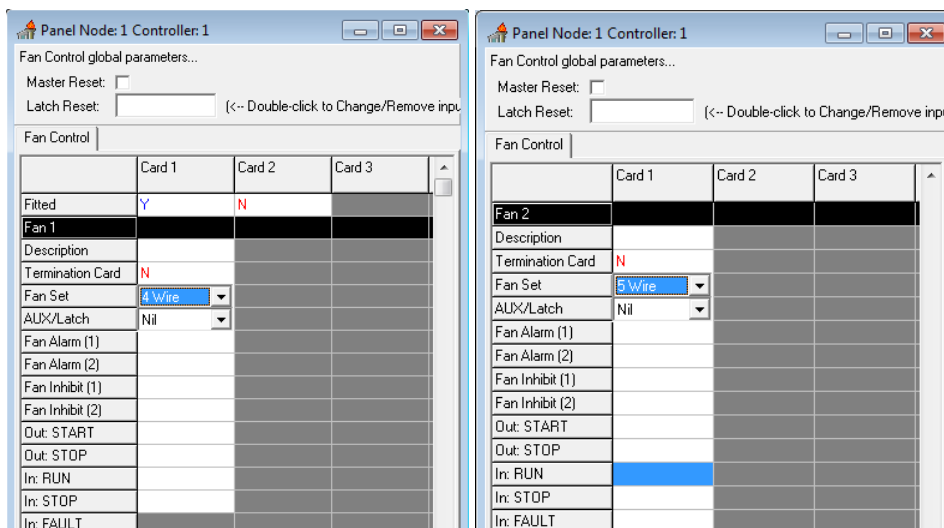

Figure 39: 4 Wire Fan Control Screen & 5 Wire Fan Control

Figure 40: Fan Alarm and Fan Inhibit editable Inputs

Figure 41: Fan Start editable Output

Figure 42: Run / Stop / Fault Editable Inputs

Edit Output ✖

Output Type

Logical Point

Loop Output

Panel Output

Logical Point

7	8	9
4	5	6
1	2	3
<-	0	D >>

Change

Cancel

Figure 43: Latch Reset Screen

4.6.8 Edit Switch & Indicator

Click on the “Tab” Switch & Indicator and the Edit screen will be displayed. Editable fields are:

Fitted / Not Fitted (Double click to edit Y = Fitted N = Not fitted)

Module Description (Double click to edit module description)

Switch Type Description (Double click to edit Switch Type Description)

Switch Type (Momentary or Toggle) click the to select type

Time Out (only applicable for Toggle switch operation) Double click the timeout box and enter the timeout details required (numerical editing).

Indicator (only applicable for Toggle switch operation) Double click to edit see Figure 44 below for Input type

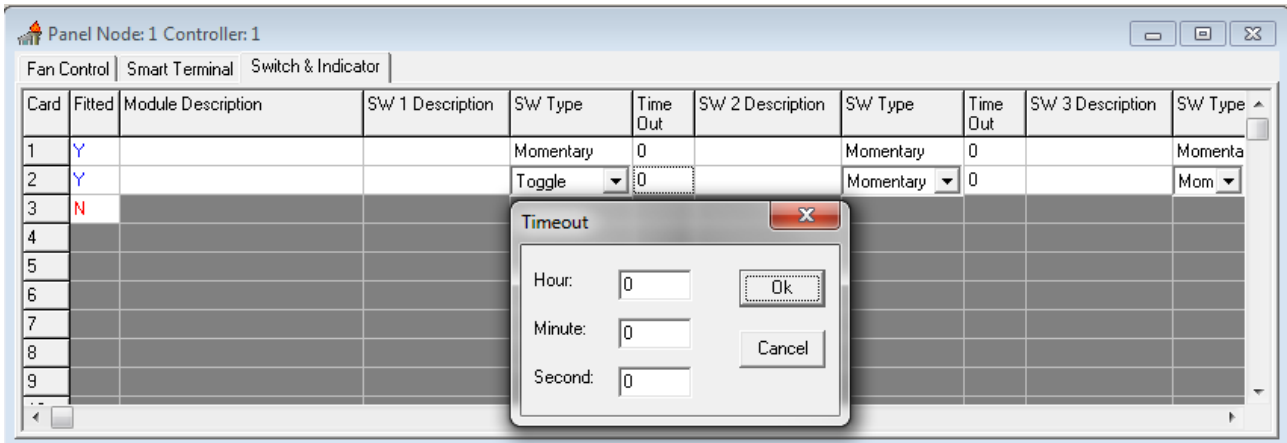

Figure 44: Switch Edit Screen

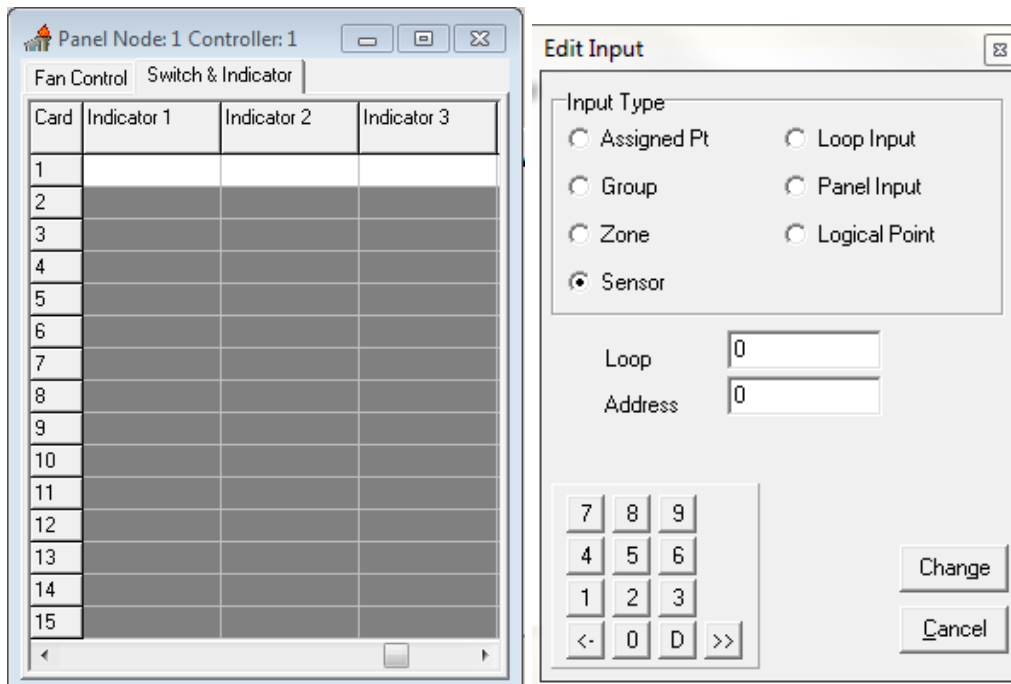

Figure 45: Indicator Edit Screen

4.6.9 Edit SmartTerminal

Click on the “Tab” **SmartTerminal** and the Edit screen will be displayed.

Panel Node: 1 Controller: 1

Module1 Apollo (1) | Module2 Apollo (2) | Module 3 Conventional (1) | Internal Serial | External LED Mimic | Agent Release | Fan Control | **Smart Terminal** | Switch & Indicator | Zone Control

Card	Active	Description	Report Alarms	Report Faults	Report Disables	Global Master Reset	NFS Enable	NFS Group	NFS Ack Timeout (second)	NFS Inv Timeout (second)
1	Y		Y	Y	Y	Y	N			
2	N									
3										
4										
5										
6										
7										
8										
9										
10										
11										
12										
13										
14										
15										
16										
17										
18										
--										

To set the **SmartTerminal** parameters click on the **SmartTerminal** tab and the following screen will be displayed. Under the assigned **SmartTerminal** Card designator, 1 to 30, click in the Active box to change the “N” (NO not fitted) to “Y” (YES fitted) and then enter or type in a “Description”. The description should be a name given to the **SmartTerminal** (LCDA) or its physical location. Double click in each of the “Report” boxes to display and set the, “Y” (Yes reports the parameter) and “N” (No does not report the parameter) “Alarms, Faults, Disables” parameters that **SmartTerminal** will display on each **SmartTerminal** at each location.



Note: A maximum of 30 **SmartTerminal**'s can be used in the configuration of the FACP.



Note: NFS Group, NFS Ack Timeout (second) NFS Inv Timeout (second) are not used under the NZ4512 standard.

4.6.10 Single Panels

If the system consists of a single panel and a single Controller then commence the configuration by right clicking on the (C1) Controller and selecting Edit Module Types or double left click on the Controller. This will display the screen as shown below

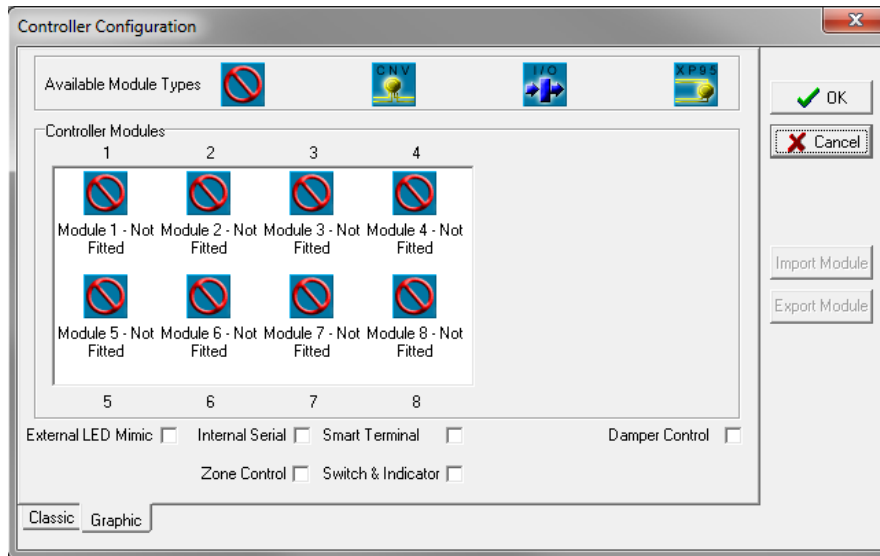



Figure 46: Controller Configuration Screen

 **Note:** Click on the check boxes (ticked) External LED Mimic, Internal Serial, SmartTerminal, Fan Control or Switch Indicator if they are to be incorporated into the configuration.

4.6.11 Modules

Description: A default descriptor is automatically entered when the *Type* is selected to make it easier to identify. The user may alter this if required.

Available Module Type: The type of the module is selected here from a drop-down list box or by using the Graphic screen where click and drag to the module is used. The modules available are the:

- Conventional Module
- Input/Output Module
- Apollo XP95 Module

Ref No: The reference number represents whether the module is the first, second, third etc of its **type**. For example if two Apollo modules are fitted the first module would have a ref. No. 1 and the second module would have the number ref No. 2. If a Conventional Module were the next module then its reference number would be 1 as it is the first module of that **type**. These numbers are unique over the whole system; they are generated automatically and should not need to be altered.

For advance users the numbering does not have to be continuous and can be altered to suit specific applications.

5 The Module Data Entry Spreadsheet

Once all the Module data for the panel has been entered, the next step is the entry of specific data for each module. This is done via the Module Data Entry Spreadsheet. To access the Spreadsheet double click on the Controller (C1)

Note: If the Controller Configuration Information has not been entered the Controller Configuration Dialogue Box will appear rather than the spreadsheet shown below.

The Module Data entry Spreadsheet appears as a window with a row of tabs along the top, one for each module. To enter the data for a module, click on the tab and in the area below a spreadsheet will appear in which you enter the data.

Sens	More	Zone	Description	Type	Type Descr	Zone Cnfg	Time Out	A/F	Rem Asc	Bell	Aux	Warn System	Alm	Spktr	Alm LED	G	R	D	U	P	S	AAF/AM
1		1		XP95 Ionisation	SMOKE	Normal	0	N	Y	Y	Y	Y	Y	N	Y							
2		1		XP95 Ionisation	FAST.S	Normal	0	N	Y	Y	Y	Y	Y	N	Y							
3				XP95 Photo Optical		Normal	0	N	Y	Y	Y	Y	Y	N	Y							
4				XP95 Thermal Std		Normal	0	N	Y	Y	Y	Y	Y	N	Y							
5				XP95 Manual Call Point		Normal	0	N	Y	Y	Y	Y	Y	N	Y							
6				XP95 Input / Output		Normal	0	N	Y	Y	Y	Y	Y	N	Y							
7				XP95 Switch Monitor		Normal	0	N	Y	Y	Y	Y	Y	N	Y							
8				XP95 Sounder Control		Normal	0	N	Y	Y	Y	Y	Y	N	Y							
9				XP95 Sounder / Beac		Normal	0	N	Y	Y	Y	Y	Y	N	Y							
10						Normal	0	N	Y	Y	Y	Y	Y	N	Y							
11						Normal	0	N	Y	Y	Y	Y	Y	N	Y							
12						Normal	0	N	Y	Y	Y	Y	Y	N	Y							
13						Normal	0	N	Y	Y	Y	Y	Y	N	Y							
14						Normal	0	N	Y	Y	Y	Y	Y	N	Y							
15						Normal	0	N	Y	Y	Y	Y	Y	N	Y							
16						Normal	0	N	Y	Y	Y	Y	Y	N	Y							
17						Normal	0	N	Y	Y	Y	Y	Y	N	Y							
18						Normal	0	N	Y	Y	Y	Y	Y	N	Y							

Figure 47: Apollo Module Data Entry Spreadsheet

5.1 Type and Zone Configuration (Zone Cnfg)

Note: These screens below have been expanded to show the entire Menu for demonstration purposes. This action is not possible in the actual process and the scroll buttons will have to be used to view the entire selection.

To select the “Type” of module or device click on the item from the drop down menu or the  in the tool bar or right click in the box and use the “Select Device”.

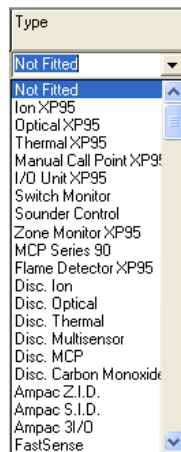

Figure 48: Device Type

The appropriate “Zone Config” is then selected from the second drop down box.

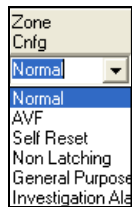

Figure 49: Zone Configuration (Zone Cnfg) Type

If a device is selected, such as I/O Modules, that requires programming or settings the “More” column will indicate this by automatically inserting a **+** in the column. Double clicking on the **+** will open another screen in which control data for that device can be entered. This is covered in more detail later in the manual under Input / Output Settings

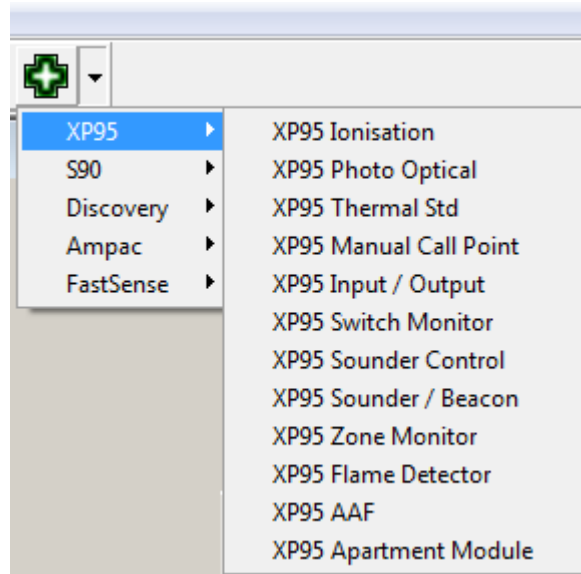

Figure 50: Short cut Window

This shortcut selection screen is selected by right clicking within a column within which a selection is to be entered.

Select Device: categorises the types of devices that can be selected

Fill selection: is used to fill and number multiple sensors of the same type. This is done by entering the first description or type etc then left clicking on it and dragging the

Cursor down to the last desired insertion point.

Cut, Copy, Paste and Delete: are used to edit either single or multiple entries in the normal way.

5.1.1 Specific Device Settings

Example of setting devices to a specific Zone Config;

XP95 Thermals:

Heat A: Specifies XP95 Thermal Type A device is fitted (Rate of rise).

Heat B: Specifies XP95 Thermal Type B device is fitted (Fixed).

AAM Modules:

Investigation Alarm: Allows for an investigation period before the device goes into full alarm.

5.1.2 Input Output Device Settings

When dealing with IO devices on an Apollo loop as part of a **FireFinder Series II** system there are two main modes of operation.

Mode 1: (Alarm Calling)

 **Note:** Once an alarm is detected an Acknowledgement and a Reset is required to clear the Alarm and LCD so as to ensure the ALARM HAS BEEN NOTED and will not go un-noticed as per AS4428.

Normal: is a normal or latching configuration for the zone. This configuration will allow the detector to go straight into alarm when it detects smoke (alarm calling).

AVF: the Alarm Verification Facility allows for the system to verify that smoke has been present in a smoke detector for 10 seconds before the system will go into alarm. AVF is not recommended for I/O devices as an input is either "ON" or "OFF".

Self Resetting: the detector will be reset automatically after a predetermined period defined by the time-out parameter (nominally 30 – 60 seconds) after the alarm condition has been removed.

Non Latching: the detector will automatically return to normal after a predetermined period (normally 1 – 2 seconds) when the source of the alarm (e.g. smoke) is removed.

When an IO device is set in alarm calling mode the device is treated as an ALARM Device. This means that if any of the inputs get turned on then the device is in alarm because the inputs are associated with the device, e.g.

- If input 1 is on then loop 1 sensor 1 is in ALARM.
- If input 2 is on then loop 1 sensor 1 is in ALARM.
- If input 3 is on then loop 1 sensor 1 is in ALARM.

If any input (1, 2 or 3) goes into alarm the descriptor will be displayed. The common outputs on the brigade board of the panel are defined by the settings as shown in the columns (Bell to Alarm LED).

Mode 2:

General Purpose: If the I/O device is configured as 'General Purpose' then each input of that device has its own unique sub address on the physical device. The common outputs on the loop main configuration window become non-functional and all values are taken from the sub address window for the I/O device. This window is opened by clicking on the plus [+] symbol in the more column and allows the configuration of the inputs to be set e.g.: Inactive, General (set a Function), Latching, Non latching, Fault and labelling of the outputs. When set to General Purpose any activated input is not displayed on the LCD.

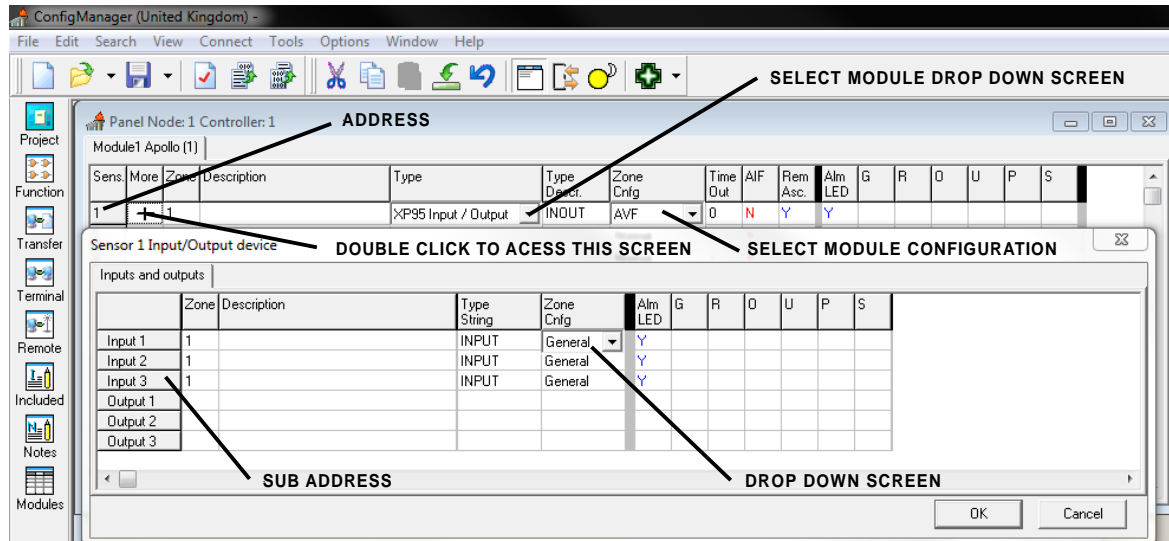

Figure 51: Setting the Module Screen

The ADDRESS will be the sequential number assigned to the device / sensor when the description is entered in the Module screen.

The SUB-ADDRESS is the INPUT designator (1 to 3) that is assigned to the description entered for a particular INPUT.

The address and sub-address of an I/O device is determined by where the device is entered into the table in the Panel Node X Controller (address) and the Sensor Input/Output device (sub-address) screens

The drop down screen under the heading of Zone Configuration (Zone Config) in the Sensor Input/Output device screen (double click on the + icon in the Panel Node X Controller screen) consists of;

Inactive: Set the input such that it will not respond to an input, accidentally or otherwise.

General: Selected when a "Function" is to be set for an input, output.

Latching Alarm: If an alarm is initiated the alarm condition input will be considered to be on by the FACP, displayed on the LCD and requires manual "Acknowledgement" and "Reset" to restore the FACP to its normal state.

Non-latching: If an alarm is initiated the alarm condition input will be considered to be on until the alarm input is removed, the input will then be seen to be in its normal state and the FACP will automatically "Acknowledge" the alarm.

Fault: If a fault condition is seen at the input to the I/O it will initiate the fault sequence as set in the configuration.

5.2 The Extended Menu and Toolbar

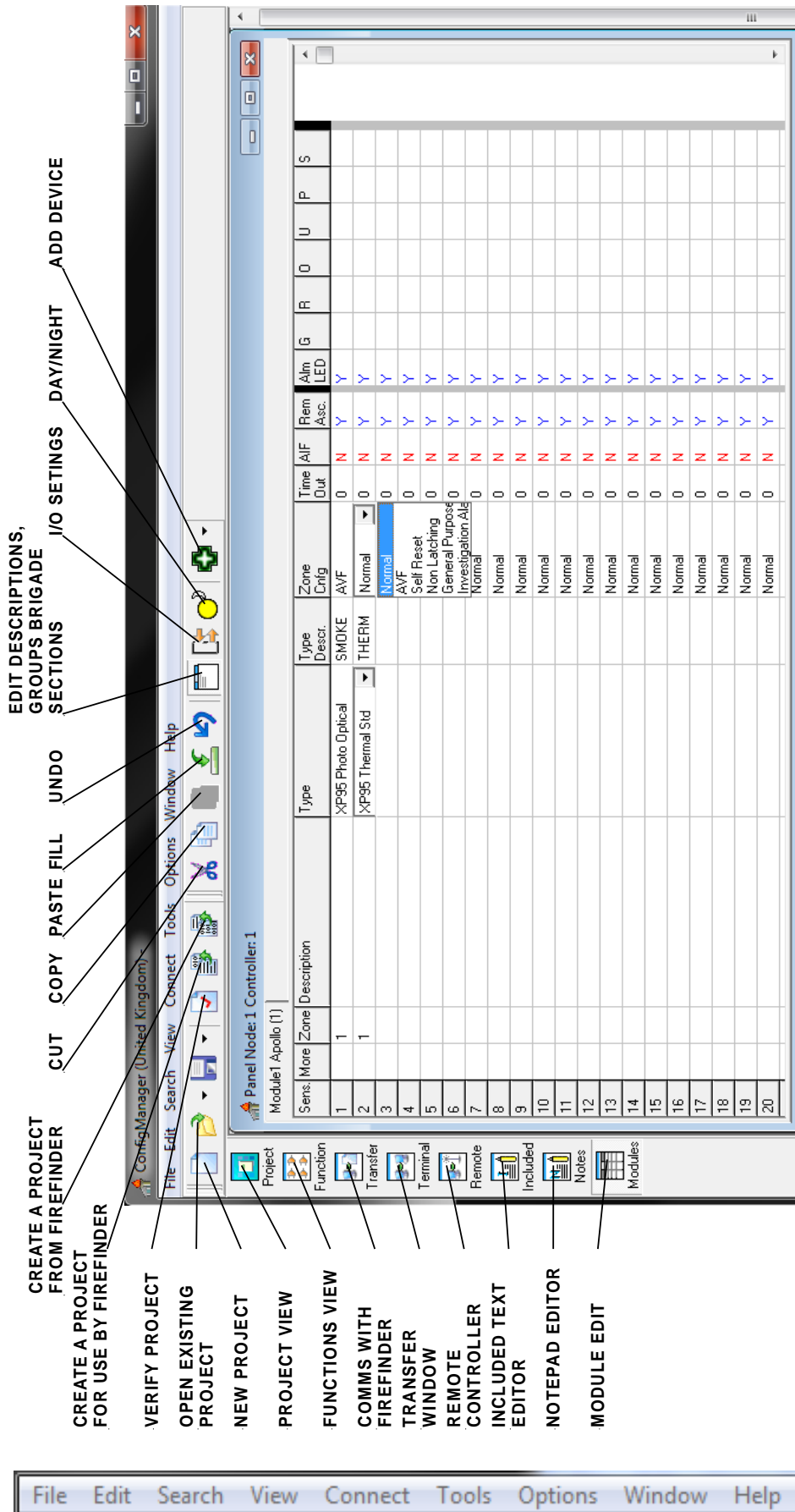
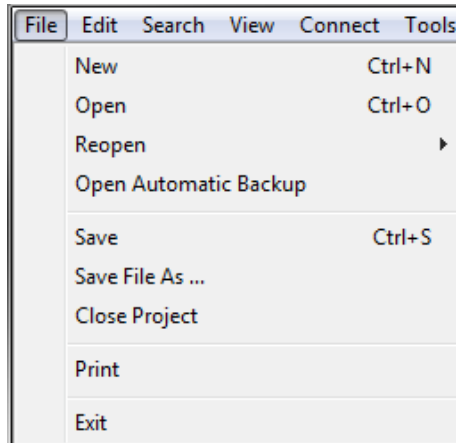

Figure 52: The Extended Functions Menu and Toolbar

5.2.1 File



New (Project) [CTRL+N]: Select this option to start a new project. The “Project Manager” dialogue box will appear as a result.



Open [CTRL+O]: Open loads a previously saved project. The “Open Project” dialogue box will appear, locate the file to be opened and click on Open. Configuration Files are saved with the .ffc extension.

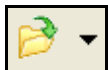

Reopen: Re-open allows the user to select from a list of previously opened files.

Open Automatic Backup: Opens the automatic saved backup file.



Save [CTRL+S]: This option is initially greyed out until a project has been created or opened a project. It will save the project to the location from which it was opened, overwriting the older version. Note that the operator will not be queried as to whether they want to do this. If working on a new project that has not been saved before the “Save Project As” dialogue box will appear instead, this is described under the next heading.



Save File As: This option is initially greyed out until a project has been created or opened. It will bring up a dialogue box to enter the file name to use for the project and to locate or create the folder in which to save it.

Close Project: This option is initially greyed out until a project has been created or opened. Click here to close the project. A Dialogue Box will asked whether or not to save it, if yes and the project has never been saved before the “Save Project As” dialogue box will appear as described above.

Print: Selecting this will bring up the Print dialogue box. From here the printer can be set up. Once everything has been checked select OK and the Module Data Entry Spreadsheet will be printed.

Exit: To close down the Configuration Module program select Exit. If changes have been made to the current project and have not saved then a Dialogue Box will asked if the operator wishes to save it now.

5.2.2 Edit

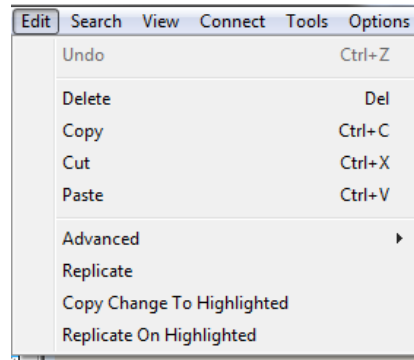

Undo [Ctrl+Z]: This will take the operator back one step in case an error has been made or a change is required while entering data into the Module Data Entry Spreadsheet. Undo can go back up to 20 steps. Holding down Ctrl and pressing Z will also implement this function.

Delete [Del]: This will clear a highlighted area on the spreadsheet. To highlight an area left click on the spreadsheet and without releasing the mouse button drag it across the area to be selected such that it is all highlighted in black. Alternatively left click on the spreadsheet, then hold down shift on the keyboard and left click somewhere else on the spreadsheet. The intervening area will be highlighted.

This function can also select by right clicking on the area to be deleted. This will bring up a menu from which to select Delete.



Copy [Ctrl+C]: After highlighting an area of the spreadsheet or selecting a single entry click on copy (or hold down Ctrl and press C) to copy it to the clipboard so that it can be pasted into another area of the spreadsheet or into another program.

This function can also be selected by right clicking on the area to be copied. This will bring up a menu from which Copy Selection can be selected.



Cut [Ctrl+X]: After highlighting an area of the spreadsheet or selecting a single entry click on Cut (or hold down Ctrl and press X) to copy it to the clipboard so that it can be pasted into another area of the spreadsheet or into another program. Unlike the Copy function however, the contents of the selected area will be deleted.

This function can also be selected by right clicking on the area to be copied. This will bring up a menu from which Copy Selection can be selected.



Paste [Ctrl+V]: This function will insert the contents of the clipboard into the spreadsheet starting from the currently selected location, assuming the data is applicable to the application. Data can not be pasted from an external application into the spreadsheet via this function, however by right-clicking and selecting Paste Descriptions. **Note:** paste **can only be done** in the **Descriptions** by this method.

Advanced: This feature modifies **Module settings** / description and to view the default parameters for that module.

Replicate: This feature works by copying the last change made to all selected cells with the same original contents as the cell that was edited. All other cells selected or not, remain unaffected. For example if it was required to change all Heat A devices to Heat C, change one of these devices configuration to Heat C, select all devices, then Edit | Replicate.

Copy Change To Highlighted: When an area is highlighted and a change is made to a selected area, if **Copy change to highlighted** is used then the change is made to all of the relevant areas in the highlighted section. For View Highlights, add Highlights refer to that Section

Replicate On Highlighted: When an area is highlighted and a change is made to a selected area, if **Replicate on highlighted** is used then the change is made to all of the relevant areas in the highlighted section.

5.2.3 Search

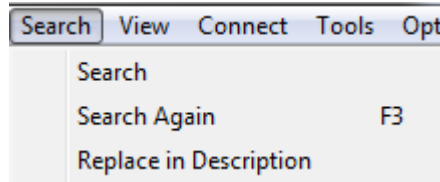

Search: This option allows the operator to search for text when editing modules.

Search Again F3: This allows the user to search for text again.

Replace In Description: This option allows the user to replace letters or words in the description fields.

5.2.4 View

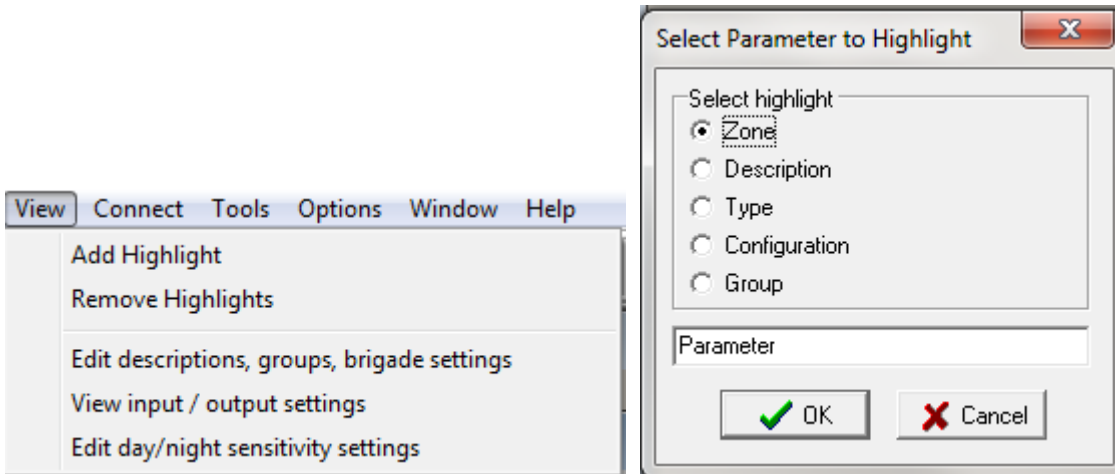

Figure 53: The Drop Down Screen & The Highlight Option Menu

Add Highlights: When this option is selected the following box appears. Select an option as shown and type in a parameter that is referred to in the region selected. In this case the word detector is entered.

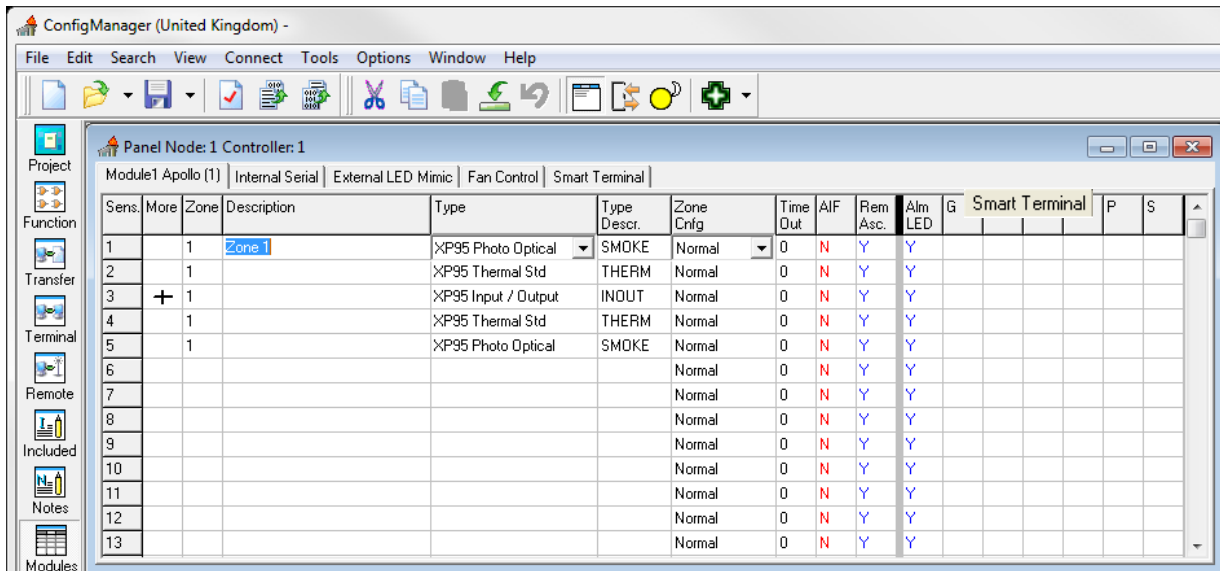

Figure 54: Highlighted Screen

Remove highlights: This simply removes the highlights on the selected screen.

The following three options from the View drop down screen if selected takes the operator directly to the appropriate working screen. Another method of selecting these options is to left click on the icons as shown below. (Only applicable if Apollo Module fitted and selected)



Edit descriptions, groups, brigade settings.



View input / output settings



Edit day / night settings.

5.2.5 Tools

Tools	Options	Window	Help
Verify Project			F4
Compile File			F5
Convert file from Fire Finder system			
Clean Up Directory			



Verify Project [F4]: This function checks that the project produces a valid *FireFinder Series II* configuration file. Any errors will be displayed on the screen.



Compile File [F5]: This function will create the *FireFinder Series II* configuration file for the current project. This is the file that is actually sent to the *FireFinder Series II*.

A **SAVE FILE AS** dialogue box will appear so that you can select the file name and location of the file you are creating. The file created is a text file with a .dat extension.

By using the Compile tab of the Environment Settings you can select to display the Compiled *FireFinder Series II* File and a window will appear showing the contents of the file after it has been generated.



Convert File from *FireFinder Series II*: This will convert the information previously uploaded from the *FireFinder Series II* panel into a format such that it can be imported for use by *ConfigManager (*.ffc)*.

Clean Up Directory: Used to cleanup file locations and unused files within that location

5.2.6 Clicking Icons



Project: View displays the current project screen



Functions: View displays the Functions screen



Connect to FireFinder Series II: This will bring up Transfer Wizard window showing communications **to** and **from** the **FireFinder Series II**. Refer to the programming section of this manual for more information.



Terminal: displays the “establish comms with **FireFinder Series II**” screen



Remote: Controller displays a graphical screen from which the FACP can be remotely controlled via modem



Included: Text Editor displays the written Functions screen for editing a written Function



Notes: Editor displays an enter text screen for storing notes on the project



Modules: Edit View displays the modules in the configuration for editing, adding or deleting



Maps: displays the map name and the description of each page in the graphics configuration

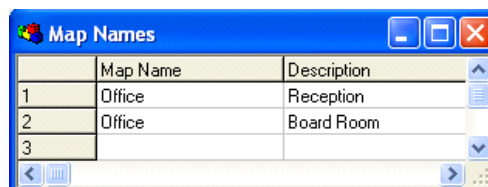

Figure 55: Entering Map Names and Screens

5.3 Apollo Modules

Selecting an Apollo module tab on the Module Data entry Spreadsheet will display the page for entering the data for that module. The tool bar will also have the following buttons made active.



Edit description, groups, brigade settings



View input / output settings



Edit day / night sensitivity settings



Add device to currently selected address

Select the tool for the settings you wish to enter.

5.3.1 Edit Sensor Properties

Selecting this option will display a page on the spreadsheet like that shown below.

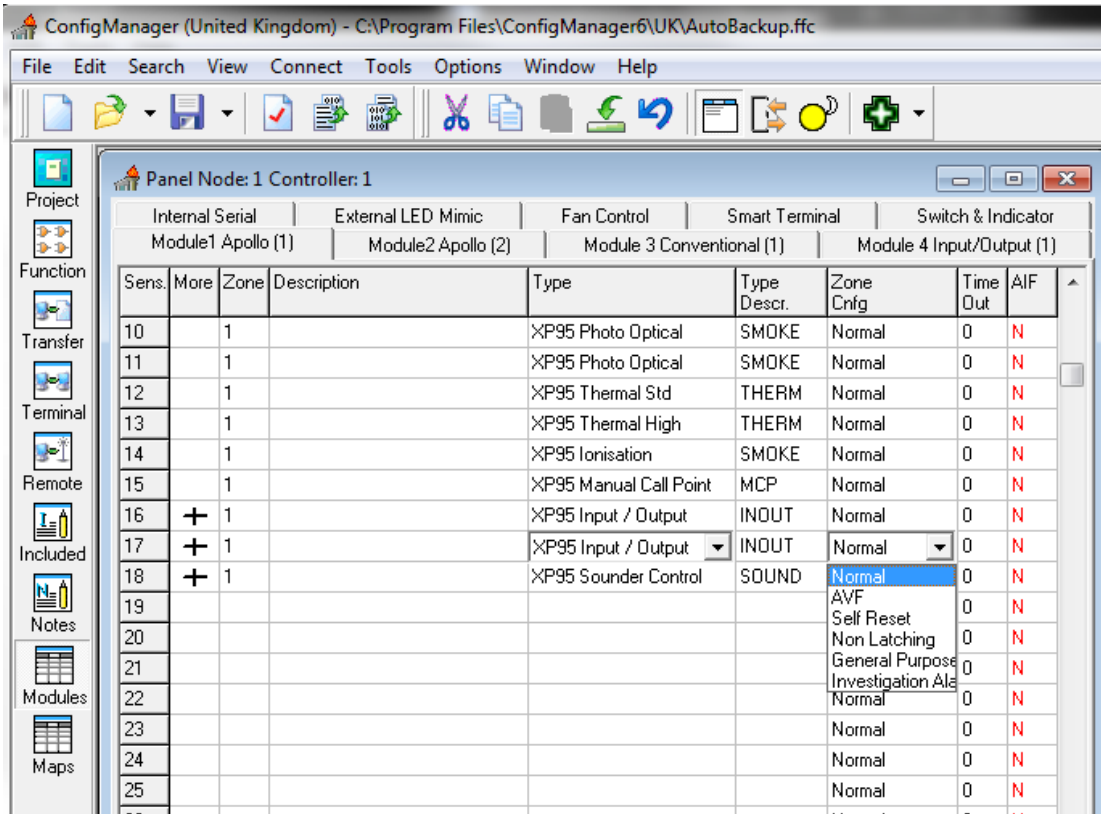

Figure 56: Sensor Properties



Sens (Sensor): The sensor number is set and cannot be modified.



More: Clicking on this box will reveal more information about the device only if it is an I/O device.



Zone: The zone number is mandatory and must be a number between 1 and 1024.

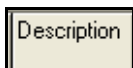

Description: The description is limited to 33 characters and may contain numbers or characters.

Type

Type: The type of device is selectable from a drop down list box.



Note: Along with other devices **FastSense** is selected from this drop down box.

Type	Descr.
------	--------

Type Descr (Description): The type descriptor is automatically entered by the program. This may be modified if required but it is limited to 6 characters.

Zone	Cnfg
------	------

Zone Cnfg (Configuration): The zone config column uses a drop down list box to display the options that a device may be set to, these are;

NORMAL: Normal or latching configuration for the zone. This configuration will allow the detector to go straight into alarm when it detects smoke (alarm calling).

AVF: Alarm Verification Facility. This configuration allows for the system to detect that there is a true alarm before the detector will go into alarm.

Self Reset: The detector will be reset automatically after a predetermined period.

Non Latching: this is non-latching. The detector will automatically return to normal after a predetermined period when the source of the alarm e.g. smoke is removed.

General Purpose: Used for input output devices. When set to general purpose any activated input is not displayed on the LCD. When using sub addressing input output units are set to general purpose. Clicking on the + (more) button will then allow you to set inputs for other options e.g.: Inactive, General (set a Function), Latching, Non latching, Fault. The **ADDRESS** will be the sequential number assigned to the device / sensor when the description is entered in the Module screen. The **SUB-ADDRESS** is the INPUT designator (1 to 3) that is assigned to the description entered for a particular INPUT. To access this screen click on the + icon in the Module screen.

Investigation: (Delays to Outputs EN54-2:1997:7.11 / AS7240.2-2004:7.11)

This is an investigation and coincidence facility for activation of sounder and/or fire outputs.

Dual Stage: MultiSensor Detector Smoke Pre-Alarm Heat Alarm

AAF: The Alarm Acknowledgement Facility (AAF) at the panel is supported by assigning an AAF Group number to an XP95 AAF device facilitating association with trigger devices assigned to the same AAF group. Supported AAF trigger devices include all alarm calling loop devices excluding I/O devices, Manual Call Points and Heat detectors.

Dual Stage (AAF): As with AAF but using a Multisensor Dual Stage Activation. The Smoke alarm is silence able, when the Heat detector activates the panel will go into alarm

LOCAL: Doesn't call the brigade

Time	Out
------	-----

Time Out: This column is the used to enter the time out that is used only for Self Resetting and investigate alarm devices. A maximum of 300 seconds is allowable. *If something greater than 300 seconds is entered an error message will be displayed when the project is compiled*

AIF

AIF (Alarm Investigation Facility): If this box is set to Y (Yes) the device is set to respond as an Alarm Investigation Facility.

Rem	Asc.
-----	------

Remote Association: Set to Y allows the remote LED to be illuminated on Alarm, set to N disables the remote LED and will not be illuminated on Alarm although if the LED was under program control within a Function this setting will be over ridden. An example of its use is where a detector is located in a concealed space (e.g. Ceiling void) and the remote LED is mounted on the ceiling in full view.

Alm	LED
-----	-----

Alm (Alarm) LED: Is the Front Panel Alarm LED. This normally set to Yes.



Groups: The next six columns allow the user to enter up to 6 group numbers against each device. These group numbers are only used for I/O programming.



Map: If graphics have been installed this column will be active and display the graphics page the device will be displayed.

5.3.2 Input/Output Settings

If there is any device on the loop which has input or output, select the Input/Output icon for I/O

Module or the More **+** column settings button in the Sensor Properties screen to show the I/O Settings page.

Some boxes in a spreadsheet will be filled with the background colour, data entry is prohibited in these boxes.

Clicking on the More + column presents the module edit screen.

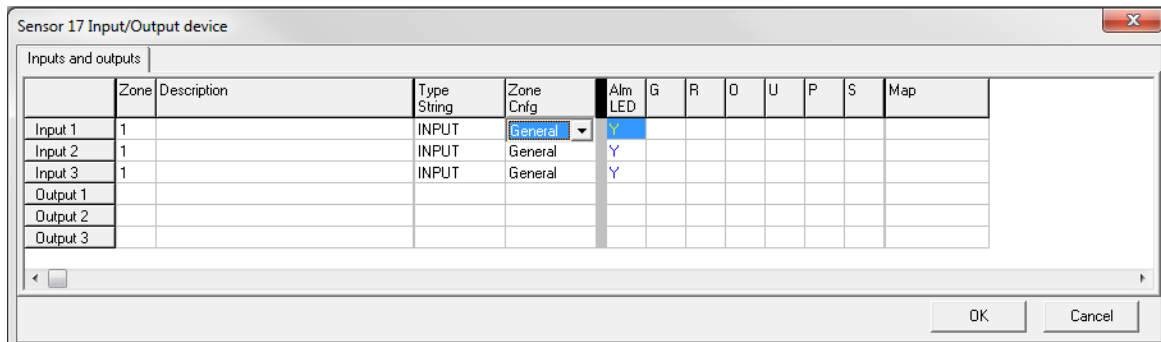

Figure 57: The Module Apollo I/O Settings Screen

The address and sub-address of an I/O device is determined by where the device is entered into the table in the Panel Node X Controller (address) and the Sensor Input/Output device (sub-address) screens.

The drop down screen under the heading of Zone Configuration (Zone Config) in the Sensor Input/Output device screen (double click on the + icon in the Panel Node X Controller screen) consists of;

General: General is selected when a non alarm calling device is used or where an input / output is used in a "Function". The change of state at the input is actioned and entered into the Logs.

Inactive: Sets the input so that it will not respond to a change of state at the input. An example of its use would be where one or two inputs of a 3 I/O device are not used.

Latching: If an alarm is initiated the alarm condition input will be considered to be on by the FACP, will be displayed on the LCD, is entered into the Logs and requires manual "Acknowledgement" and "Reset".

Non-latching: If an alarm is initiated the alarm condition input will be considered to be on until the alarm input is removed, the input will then be seen to be in its normal state and the FACP will display the condition on the LCD, is entered into the Logs and automatically "Acknowledges" the alarm.

Fault: If a fault condition is seen at the input to the I/O it will initiate the fault sequence as set in the configuration, display the condition on the LCD, enters it into the Logs and automatically "Acknowledges" the fault.



To view and print the settings select the icon and print.

Sens.	Zone	Description	Type Descr.	Zone Cnfg	Time Out	G	R	O	U	P	S
Sens. 16											
Input 1	1		INPUT	General	0						
Input 2	1		INPUT	General	0						
Input 3	1		INPUT	General	0						
Output 1				General							
Output 2				General							
Output 3				General							
Sens. 17											
Input 1	1		INPUT	General	0						
Input 2	1		INPUT	General	0						
Input 3	1		INPUT	General	0						
Output 1				General							
Output 2				General							
Output 3				General							
Sens. 18											
Output 1				General							
Output 2				General							

Figure 58: The Module Apollo I/O View and Print Screen

Note: To edit this information / screen return to the Edit Sensor Properties, double click on the More + box then edit in the new screen, returning by exiting in the normal way.

I/O	Input	Input Active	Output Description	Output Active
1	I	Y		N
2		N		N
3		N		N
4		N		N

Fig 1: Module Edit I/O Screen

Sens: The Sensor number is set and cannot be modified.

Description: The description is limited to 33 characters and may contain numbers or characters.

Active: Toggling the values in this column will activate or deactivate the input or output.

I/O: The I/O number is set and cannot be modified.

Description: The description is limited to 33 characters and may contain numbers or characters.

Input / Output, Active / Inactive: Toggling the values in this column will activate or deactivate the input or output.

5.3.3 Day/Night Settings

If Day/Night settings are not required then this section may be ignored. If they are required select the

icon  and the screen below will be displayed.

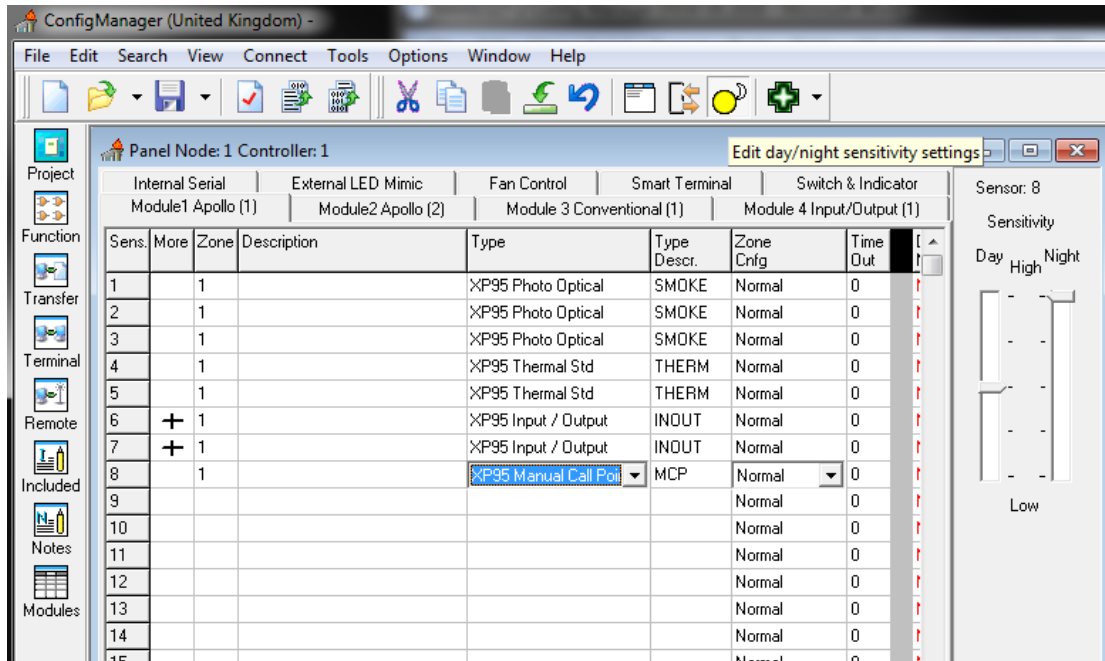

Figure 59: The Day / Night Settings page (Note Sensitivity & Mode Default Settings)

To activate the day/night settings on a device, click in the Day/Night column in the spreadsheet, this will toggle between Y and N, set the entry to Y.

XP 95 & FastSense Day / Night Settings: The two sliders on the right of the page show the Day/Night sensitivity settings; by moving them you change the values in the Day/Sens. and Night/Sens. Columns. **The lower the number the more sensitive the detector.** The number is a percentage of the normal level of the initiating factor that would cause an alarm. E.g. an analogue return value of 55 for an alarm would return approximately 47 for a setting of 80%. Once set the sensitivity has to be enabled via the Function Menu on the panel for it to take control.

Discovery Day / Night Mode Settings: Selecting a Discovery device will enter a default value of 3 for both day and night. To set it for a particular mode click on the inserted number, delete and enter a new value between 1 and 5. Entering any other value will result in an error message, delete the entry and re-enter. E.g. In relation to Smoke detectors **the least sensitive setting is Mode 5 while Mode 1 is the most sensitive.**

 **Note:** MCP's will return a default value of 15; this value can not be changed.

5.4 Conventional Modules

Selecting a Conventional Module tab on the Module Data entry Spreadsheet will display the page for entering the data for that module.

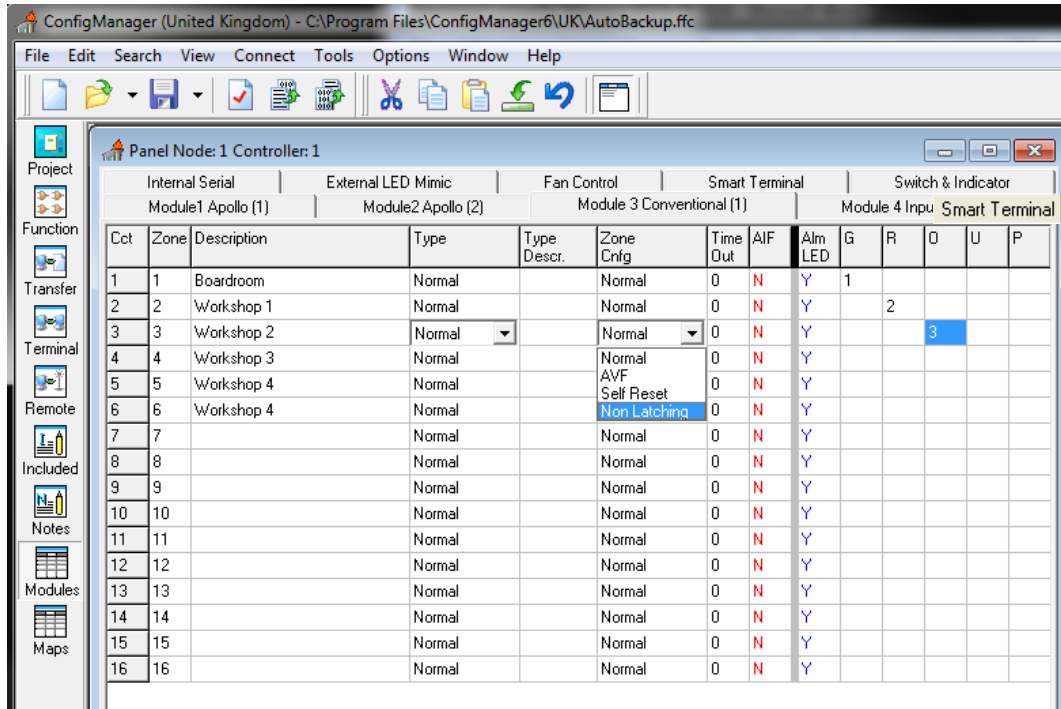

Internal Serial		External LED Mimic		Fan Control		Smart Terminal		Switch & Indicator					
Module1 Apollo (1)		Module2 Apollo (2)		Module 3 Conventional (1)		Module 4 Input Smart Terminal							
Cct	Zone	Description	Type	Type Descr.	Zone Cnfg	Time Out	AIF	Alm LED	G	R	Q	U	P
1	1	Boardroom	Normal		Normal	0	N	Y	1				
2	2	Workshop 1	Normal		Normal	0	N	Y		2			
3	3	Workshop 2	Normal		Normal	0	N	Y			3		
4	4	Workshop 3	Normal		Normal	0	N	Y					
5	5	Workshop 4	Normal		Normal AVF Self Reset	0	N	Y					
6	6	Workshop 4	Normal		Non Latching	0	N	Y					
7	7		Normal		Normal	0	N	Y					
8	8		Normal		Normal	0	N	Y					
9	9		Normal		Normal	0	N	Y					
10	10		Normal		Normal	0	N	Y					
11	11		Normal		Normal	0	N	Y					
12	12		Normal		Normal	0	N	Y					
13	13		Normal		Normal	0	N	Y					
14	14		Normal		Normal	0	N	Y					
15	15		Normal		Normal	0	N	Y					
16	16		Normal		Normal	0	N	Y					

Figure 60: The Conventional Module Settings Page

Circuit: The circuit number is set and cannot be modified.

Zone: The zone number must be a number between 1 and 999.

Description: The description is limited to 33 characters and may contain numbers or characters.

Type: The type of device defaults to normal within the drop down list box.

Type Descr: The type descriptor is automatically entered by the program. This may be modified if required but it is limited to 6 characters.

Zone Cnfg: The zone configuration column uses a drop down list box to display the options that a device may be set to; these are Normal, AVF, Self Reset, and Non-latching.

Time Out: This column is used to enter the time out for the Self Reset configuration. A maximum of 999 seconds is allowable (60 seconds is considered a norm). An error message will be displayed if the operator attempts to enter something greater than 999 seconds.

Auxiliary Output: The next column is used to determine if the Alarm LED on the main control panel is active.

Groups: The next six columns allow the user to enter up to 6 group numbers against each device. These group numbers are only used for I/O programming.

Map: If a graphical interface is fitted to **SmartGraphics** this column indicates the Map to which a particular detector is associated with.

5.5 Input/Output Modules

Selecting an Input/Output module tab on the Module Data entry Spreadsheet will display the page for entering the data for that module. The tool-bar will also change to include the Inputs and Outputs buttons.



Input Output settings: Selects Both Inputs and Outputs



Input setting only: Selects Inputs only



Input setting only: Selects Outputs only

The Input/Output module page has three columns displaying:

- The input (or output) numbers
- An associated descriptor
- An option to determine if the input (or output) is to be **active**.

To select if a module is to be active or inactive left-click on the box to toggle the contents between Y(es) or N(o).

To enter the descriptor just left-click on the box where you want to enter the data and type it in.

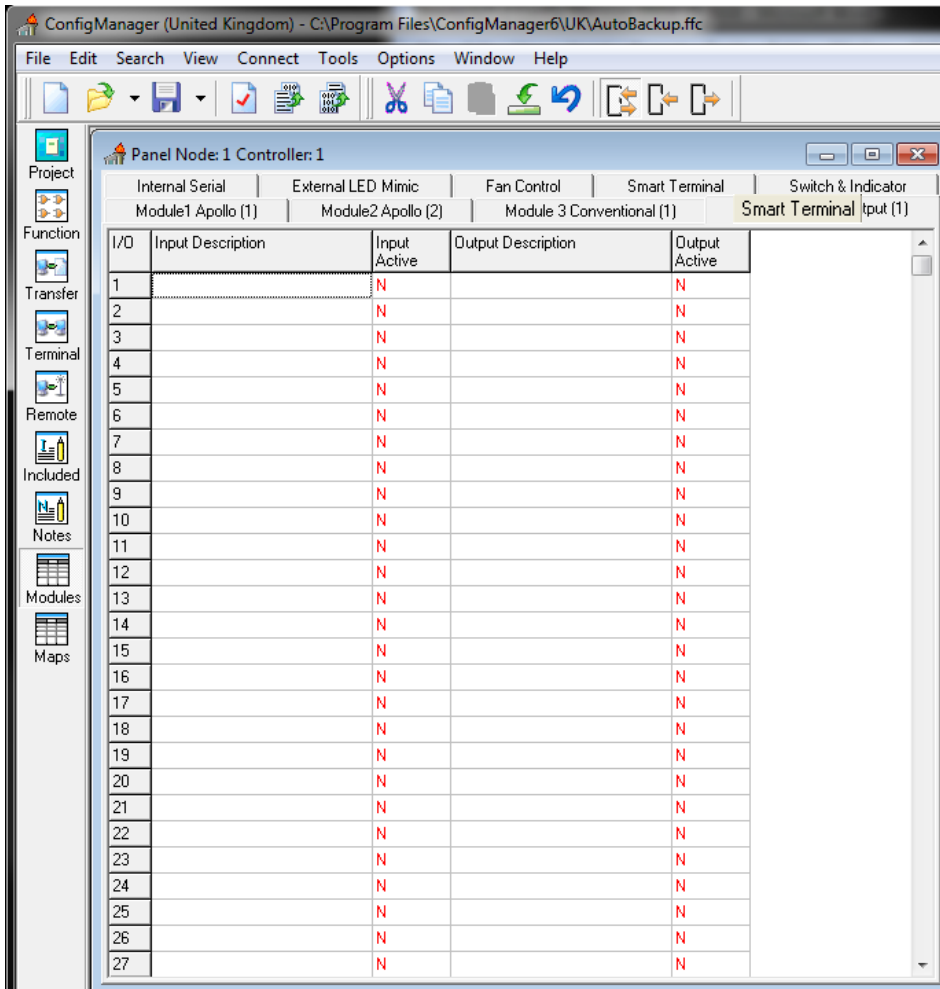

Figure 61: Input / Output Module

5.6 SmartTerminal

To set the SmartTerminal Annunciator parameters click on the tab and the following screen will be displayed. Under the assigned SmartTerminal Card designator, 1 to 30, click in the Active box to change the “N” to “Y” and then enter a “Description”. Double click in each of the “Report” boxes to display and set the, “Y” yes and “N” no “Alarms, Faults, Disables” parameters that the SmartTerminal will display on each SmartTerminal at each location.



Note: A maximum of 30 SmartTerminal's can be used in the configuration of the FACP.

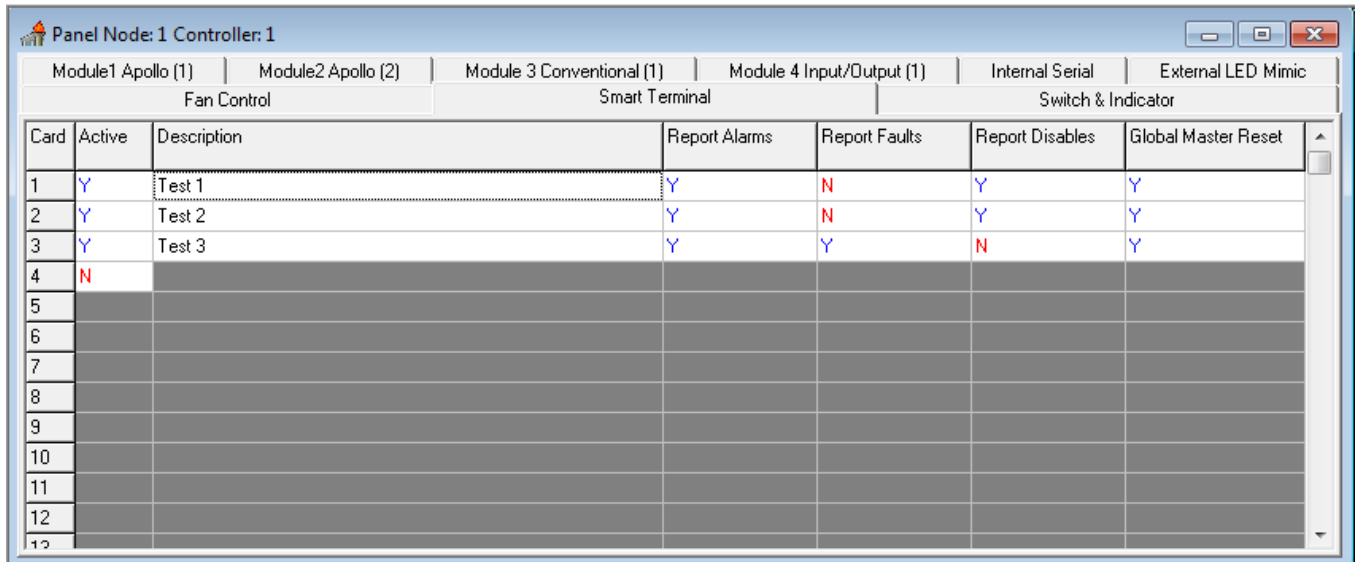

Card	Active	Description	Report Alarms	Report Faults	Report Disables	Global Master Reset
1	Y	Test 1	Y	N	Y	Y
2	Y	Test 2	Y	N	Y	Y
3	Y	Test 3	Y	Y	N	Y
4	N					
5						
6						
7						
8						
9						
10						
11						
12						
13						

Fig 2: Example of SmartTerminal Configuration Settings Screen

In the above example **Card 1 & 2;**

- Are active
- Are situated in the designated factory floor area 8
- Will display all Alarms
- Will *not* display any Faults, and
- Will *not* display any Disables

Card 3

- Is active
- Is situated in the stores area
- Will display all Alarms
- Will display any Faults, and
- Will *not* display any Disables

Card 4 & 5

- Are active
- Are situated in the security areas
- Will display all Alarms
- Will display any Faults, and
- Will display any Disables

6 Functions

This section of the program allows the operator to enter data that will allow the panel to activate outputs in accordance with the pre-determined conditions of specified alarm devices or inputs.



Function Icon

6.1 The Function View

Selecting the Function Icon will display a range of options as shown below

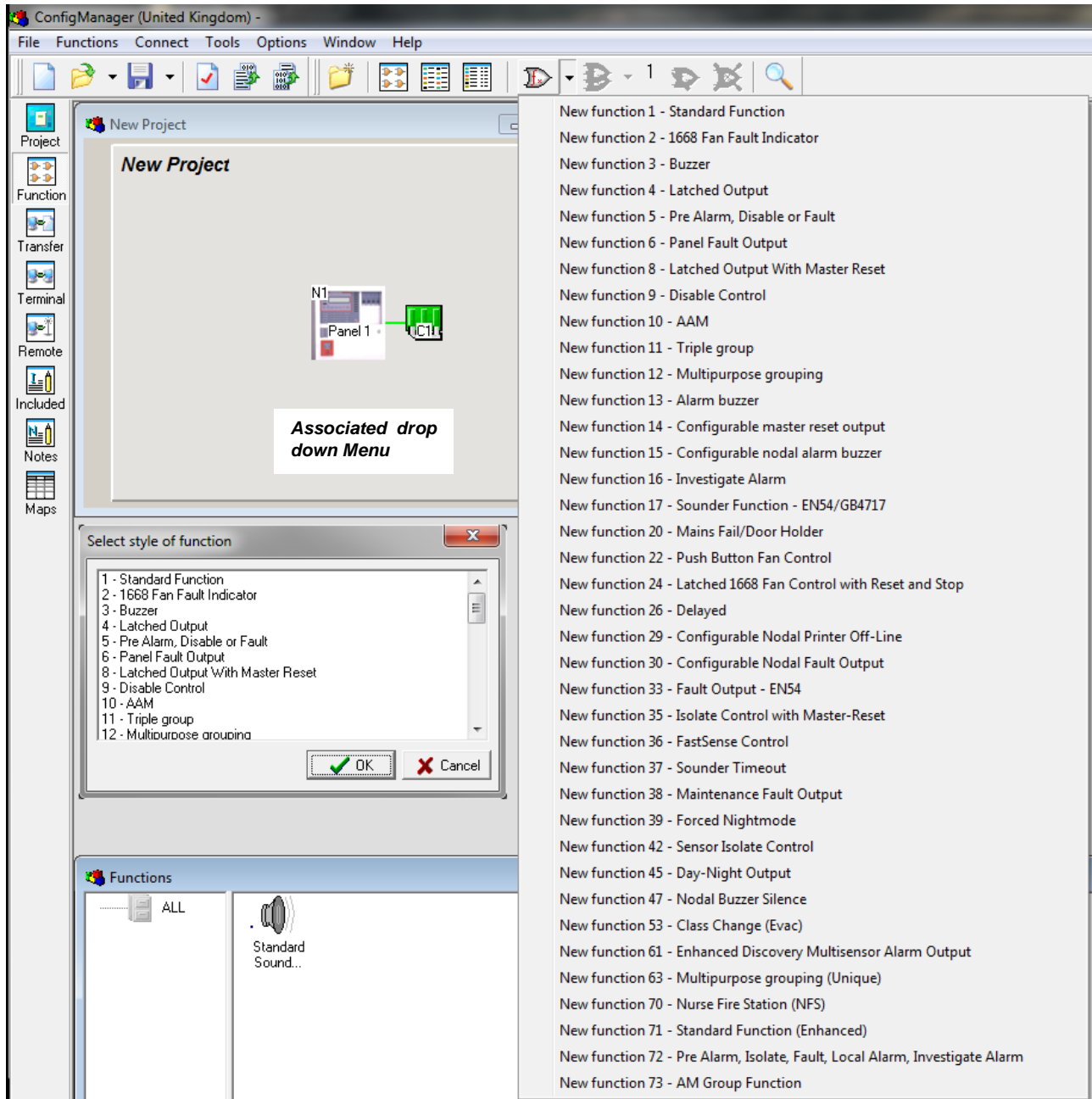
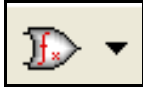

Figure 62: The Function Screen Displaying Two Un-named New Functions & Selection Menus

Once a Function is selected it can be modified to suit a particular purpose. A special feature is the availability of the Filing cabinet. This operates in the same way as the Microsoft Word and allows the saving of a Function (using Click and Drag) in the filing cabinet or folder within the cabinet for reuse at a later date.



New Functions: As seen above by selecting this icon a box will appear on the screen with a selection of functions that can be scrolled through or by selecting the arrow head a complete list will be presented.



Clone Function n Times: This option allows the operator to create the selected number of copies. Using the Project Creation tab of the Environment Settings you can select weather the cloning of a function automatically increments the entries in each selected box.



Edit Function: This will bring up a list box of the functions currently in the system from which you can select the one you wish to edit. After selecting the function you wish to edit, that function's window will appear.



Delete Function: Select this option to remove a highlighted function from the project.



Special Functions: Selecting the "Included" Tab from the extended functions tool bar opens a text editor for the inclusion of special functions. This is an advanced feature that should not be used by the novice user. If you require a *FireFinder Series II* function that is not currently handled by *ConfigManager* you can use this feature to enter text that contains the function and it will be included in the final configuration. This must be done in conjunction with an AMPAC office.



Display Large Function Icons: Functions in use are displayed as large Icons in the Functions Screen



Display Small Function Icons: Functions in use are displayed as small Icons in the Functions Screen



Display Function List: Functions in use are listed by name in the Functions screen.



New Function Folder: Create a Folder to store specific, repetitive Functions for use in a project.



Find Function with given Parameter: Finds a Function that uses specific parameters as seen in the drop down box below.

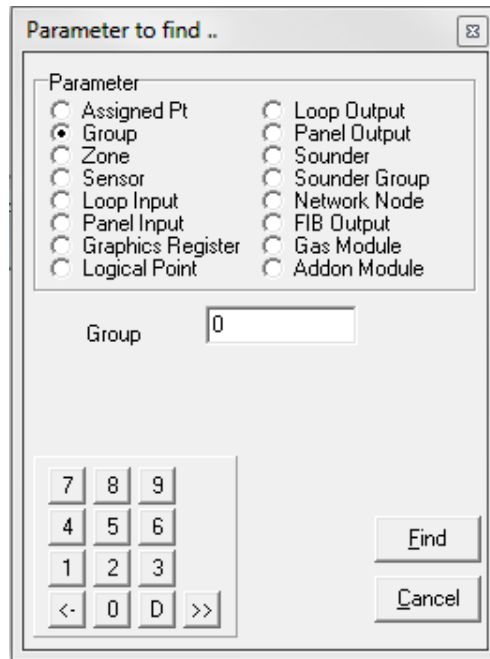

Note: For a full explanation of each Function refer to the Functions Manual

To configure a function, select **Functions / New function**. This will bring up a Function window as shown below.

Each function will have its own Function Window. This graphically displays all the elements of the function.

Up to 4 Windows can be opened at once, although you may have as many functions as you require in the system. Selecting **Functions / Edit Function** will give you a list of all the functions currently defined in the project. You can then sort them alphabetically or numerically to find the one you wish to edit.

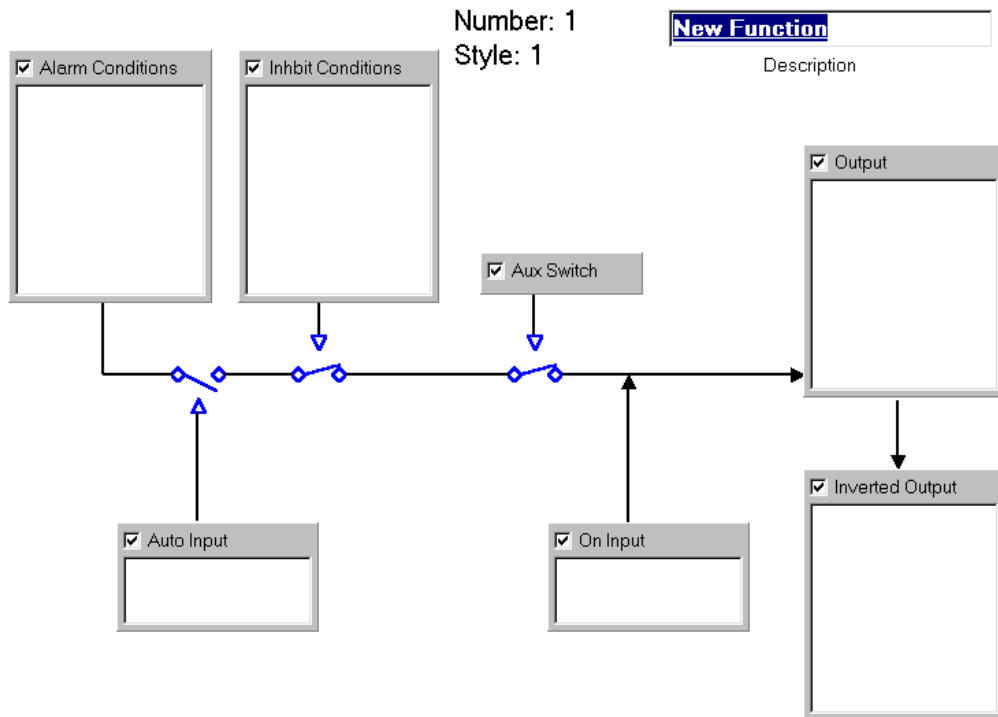

Figure 63: A Function Window

At present there are a number of functions supported by the configuration tool. These should be sufficient for programming 90% of all required functions.

Once you have brought up a functions window, the functions menu and tool-bar will change to provide you with what you require while working on functions.

Each box in the functions window represents a logical part of the function. If it is required make sure the check box in its top left-hand corner is ticked. If you do not require it uncheck the box and that logical component will not take part in the function.

Right click or double click on a box to allocate its parameters. A menu will appear giving you the options of **A**dd/**C**hange or **D**elete.

To add a new parameter, click on **A**dd/**C**hange and a dialogue box will appear so that you can set the input or output type and number.



These keys allow the operator to move to the “next” or “previous” Function in use.

7 Expanding the System

The basic *FireFinder Series II* has the capacity to support up to eight slave CPU's which in turn may be any one of the three types of hardware mentioned, Apollo XP95 loops, Conventional zones or Input/Output boards. In addition to these other types of configurations are possible.

On the tool bar shown below there are a number of items that can be selected and added to the basic configuration.



 **Add Panel**

 **Add Data Gathering Point**

 **Add Mimic**

 **Add Modules**

 **Add High Level I/F**

 **Change the project country or name:** Defaulted to United Kingdom and is an un-editable field

7.1 Adding a Panel

If a panel (N2) is added to the system it will have to be set up for the required parameters. This is done in the same way as entering control parameters for Panel 1.

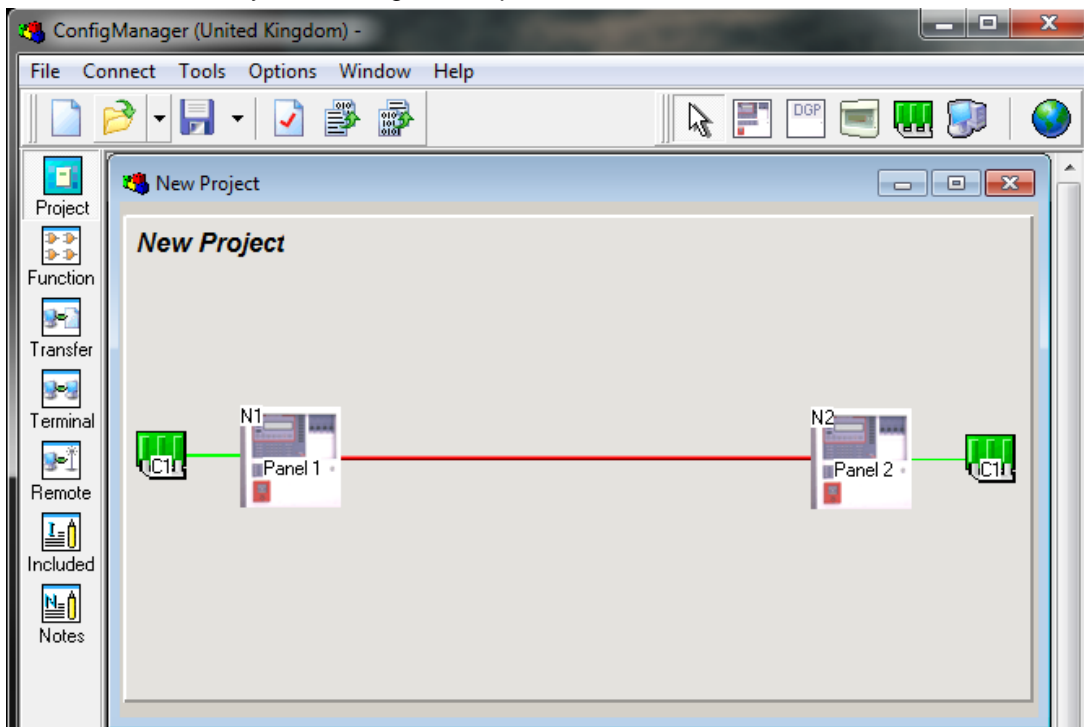

Figure 64: Adding a Panel Screen

7.2 Adding a Data Gathering Point

To add a Data Gathering Point to the system left click on the DGP icon as shown so that it is highlighted. Then left click on the mimic and the DGP will be added.

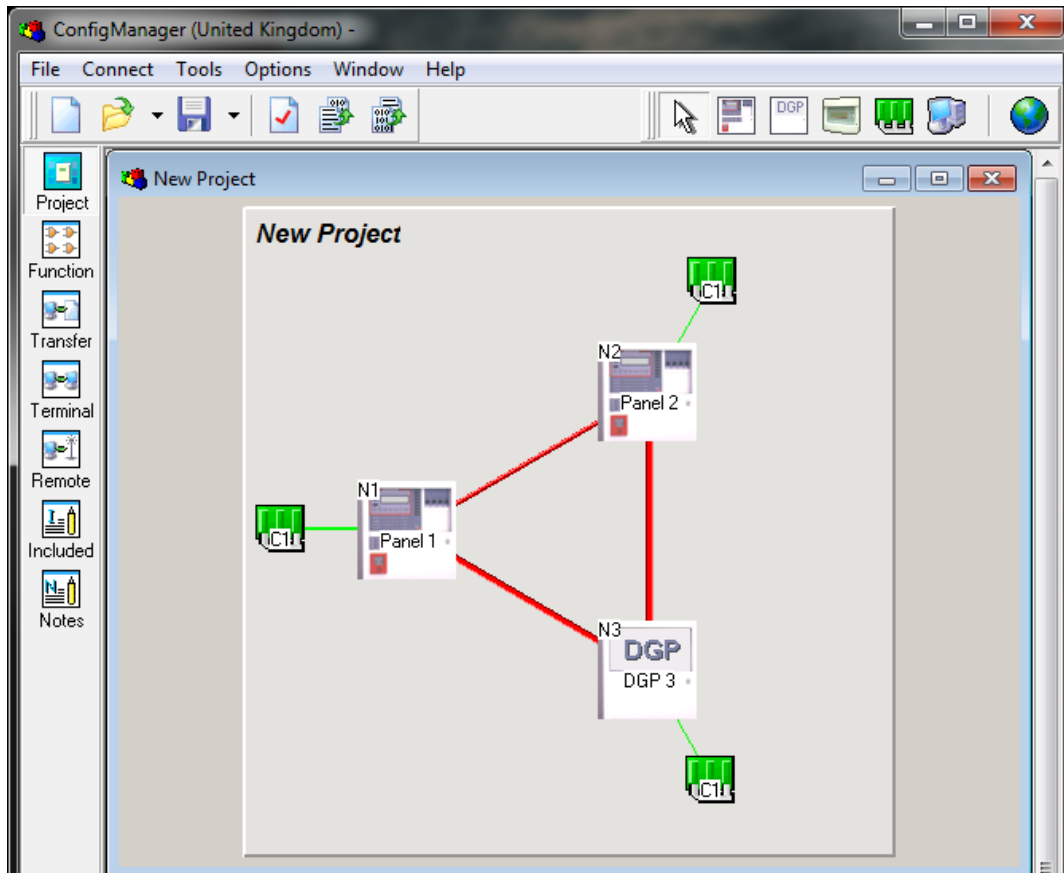

Figure 65: Adding a Data Gathering Point (DGP) Screen

Once added, double click on the DGP to open the screen shown below. Here the description and the node numbering (Reference) of the DGP can be edited. In practice it is best to rely on the auto-numbering of "Reference".

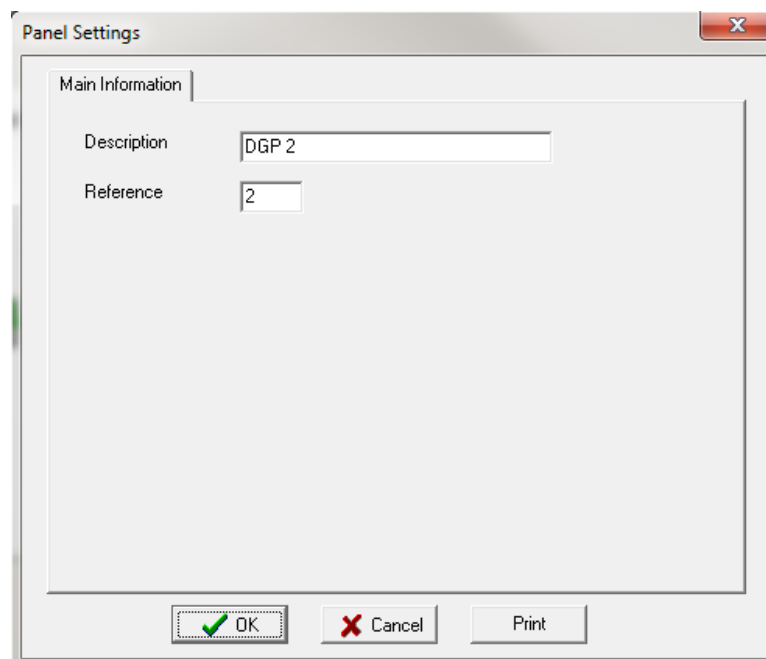

Figure 66: Adding a Data Gathering Point (DGP) Screen

C1 – the Controller parameters are then set in the same way as the others.

7.3 Adding an LCD Mimic

To add an LCD Mimic to the system left click on the mimic icon as shown so that is highlighted. Then left click on the project area of the centre screen and the mimic will be added.

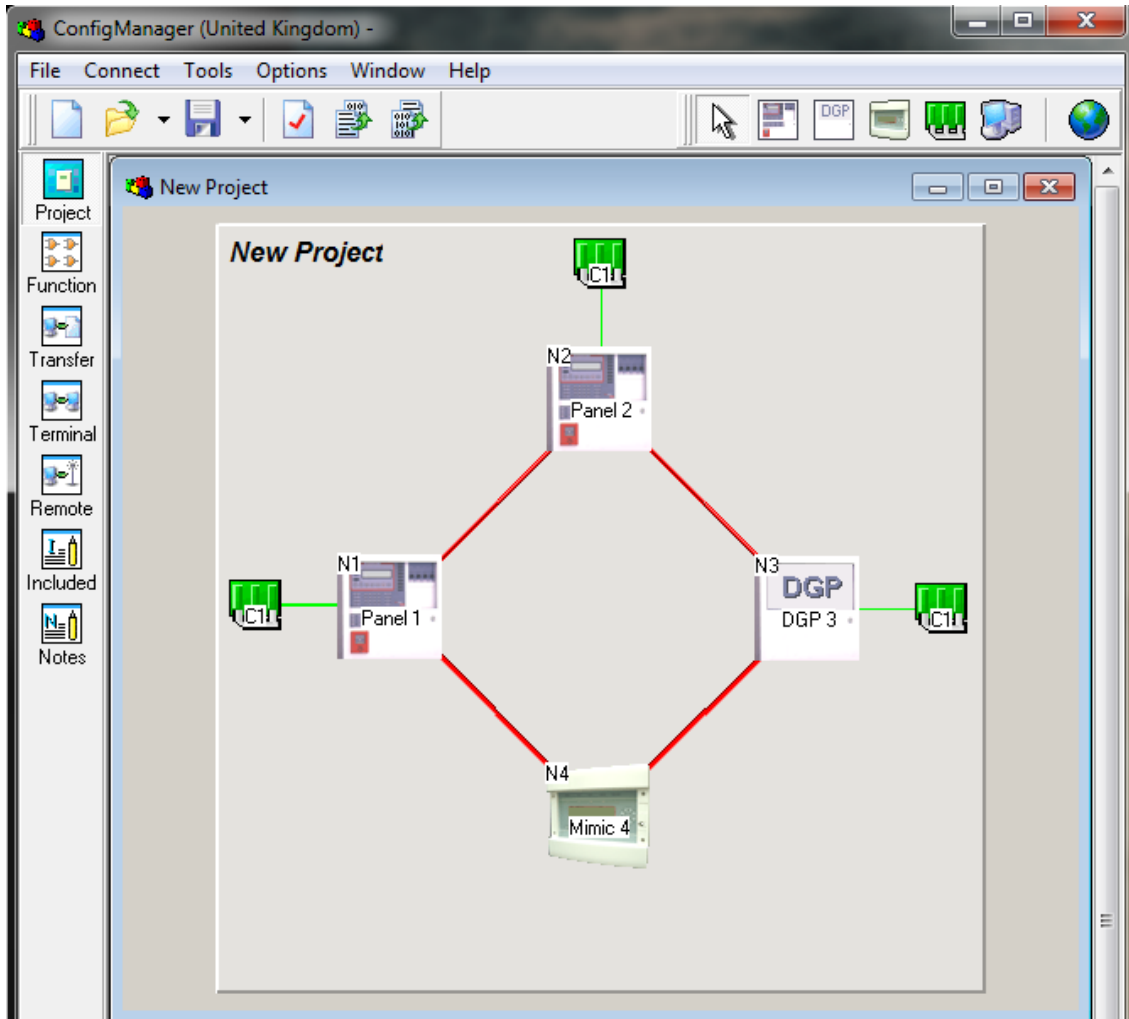

Figure 67: Adding an LCD Mimic Screen

Note: the Node address has been automatically set, e.g. N2 in the above illustration. To display an address that has already been set access the LCDR via the “debug “port, go to “Application Mode” and type in DA.

As the mimic has a number of options as to what it can display the access levels must be set. The default is Global access which means that all of the zones/devices in the system will be displayed on the LCD. This may be modified by the user by clicking on the Global access box as shown on the following page.

7.3.1 Global Access

Global Access refers to the access that any node in the network has to any other node in the same network and is accessed by right clicking on the Mimic Panel and selecting EDIT NETWORK PARAMETERS. The access refers to what the LCD will display and also what I/O functions will be operated on, and what testing is allowed. For stand alone panels the default is set to Global as the panel has full access to itself. This means for a stand alone panel with global access all of the I/O functions will be activated and all of the configuration will be displayed as required.

In a network this is selectable for each node in the network.

Selection Buttons: [only available in the Panel screen]

Invert Selection: Selects / de-selects the highlighted panels.

Select None: De-selects all Panels shown on the screen and is of particular use on larger networks.

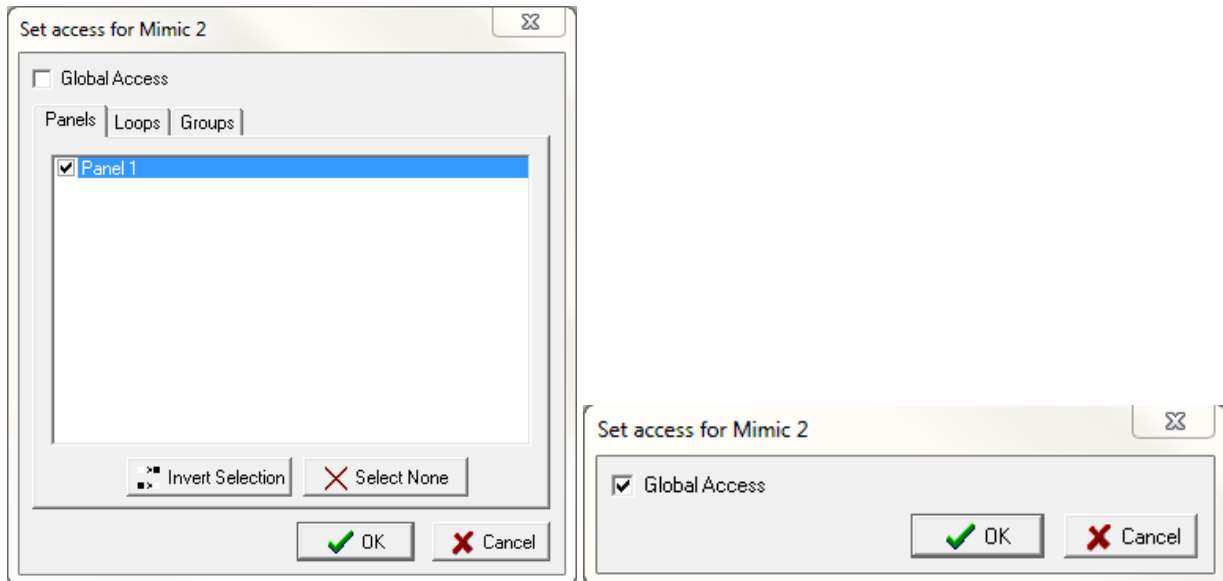

Figure 68: Panel, Loop, Group and Global Access screens

7.3.2 Panel, Loop or Group Access

If Global access is not selected then the user has the option to select any combination of Panels, Loops or Groups. This option allows the user then to determine what parts of the system any node may display, test, or affect the I/O (cause and effect).

The **LCD** access may be set to Global, Panel, Loop, or Group access. If the user only wanted particular information to be displayed then by selecting the Panels Loops or Groups option they could limit the information displayed. For example if the groups option was selected and group 2 was entered then only zones or devices with group 2 selected in the Group columns of the data entry spreadsheet would be displayed. If Loop 1 was entered then all of the devices on loop 1 only would be accessed, and finally if panels 1 and 2 were entered then only information from panels 1 and 2 would be accessed. The access for the mimic can be defined by either panels, loops or groups.

7.3.3 Mimic Settings

The Mimic Panel settings are configured by double clicking on the Mimic in the project screen. The Main Information screen will be displayed. It is here that the description, reference and the default display can be edited. As can be seen below each parameter has been set and the default display reflects that shown in the Programmable Switches screen. The Programmable Switches screen is selected by clicking on Tab Programmable Switches. The functions of the two switches can now be set by using the two drop down menus, as can be seen below Alarm Acknowledge has been selected for Switch 1 and Reset is about to be selected for Switch 2. Click OK to set.

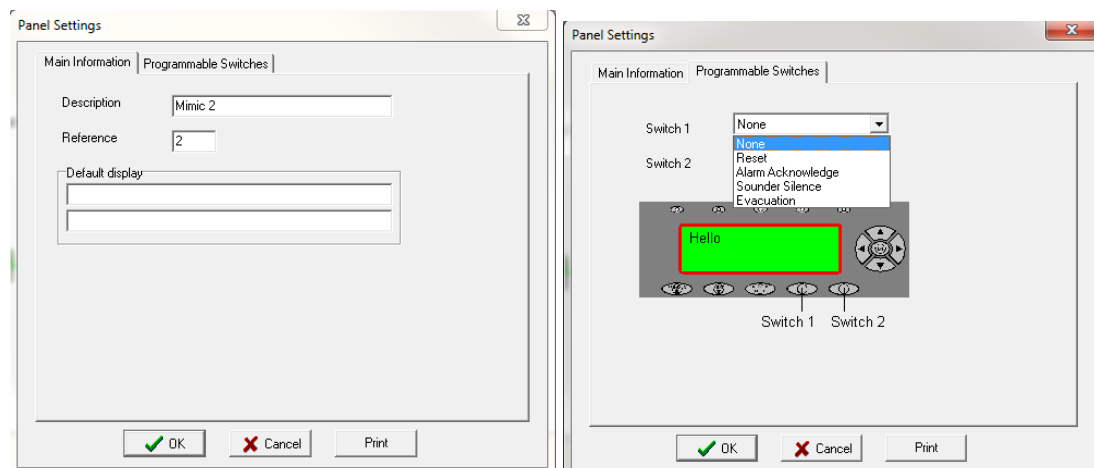

Figure 69: Screens for Editing the Mimic Settings

7.4 Adding Modules to a Panel

To add to a Panel left click on the Add Modules icon as shown so that is highlighted. Then left click on the Panel and the Modules will be added. The types of modules and their operating parameters will then have to be entered. This is achieved by left clicking on the C2 icon on the screen and setting them through the Controller Configuration “Classic” or “Graphic” pop up screens.

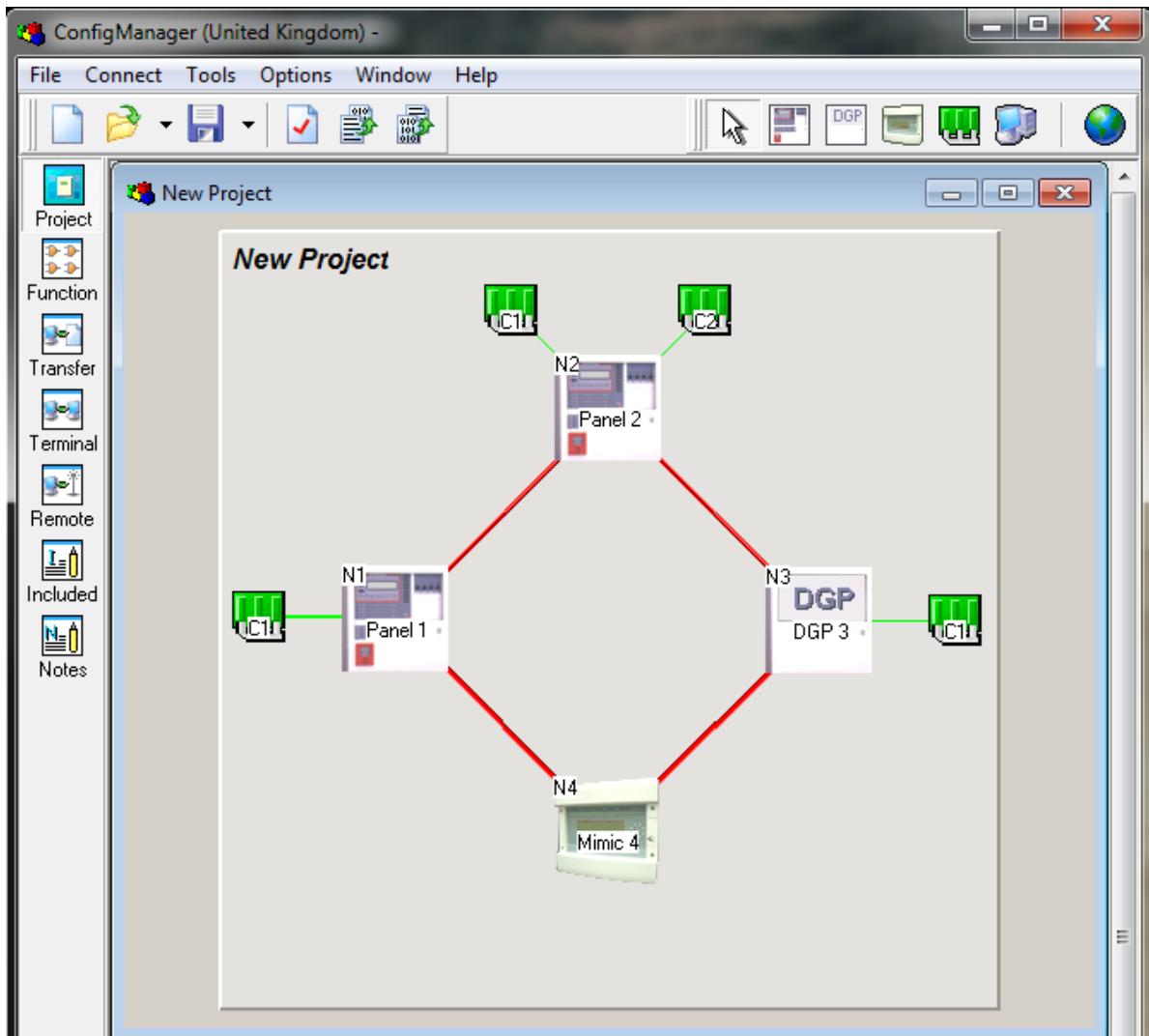

Figure 70: Adding Modules to a Panel Screen

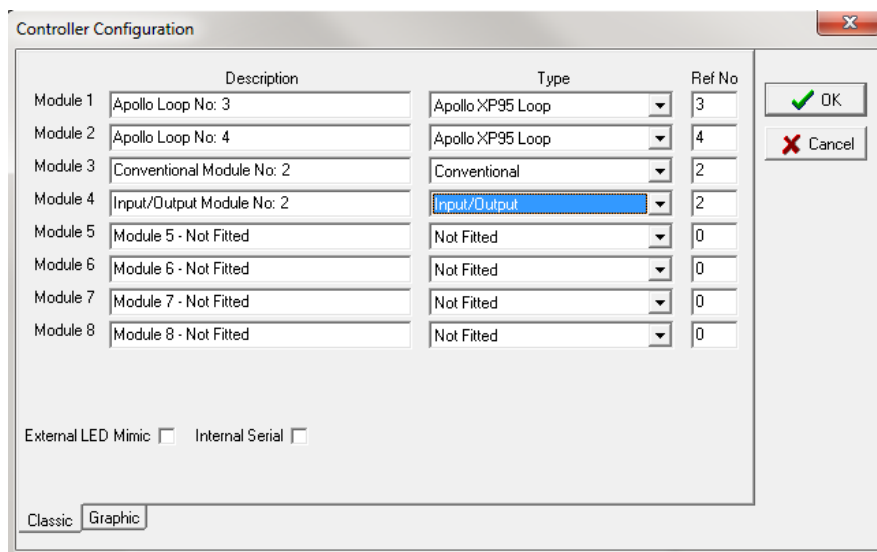

Figure 71: Controller Configuration (Classic)

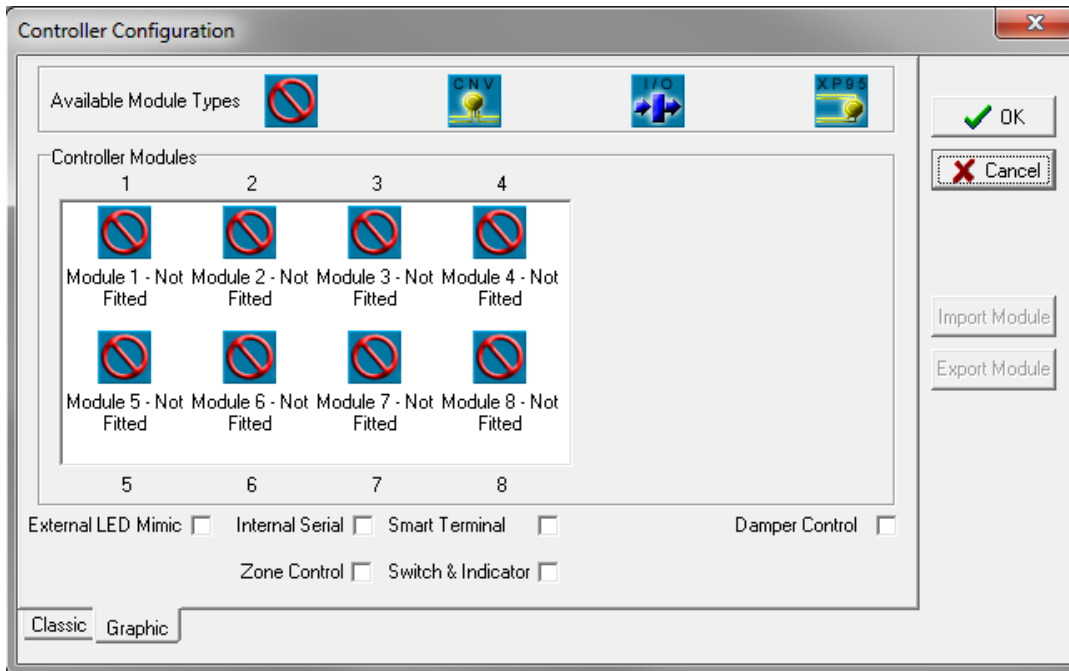

Figure 72: The Controller Edit Module Types Classic and Graphic Screens

The screens shown here are for C1 with Smart Terminal C2 will have the same screens except there will be no SmartTerminal available.

7.5 Adding a High Level Interface (HLI)

Another item that may be selected and added to the system is a HLI. To add a HLI to the system left click on the HLI icon as shown so that is highlighted.

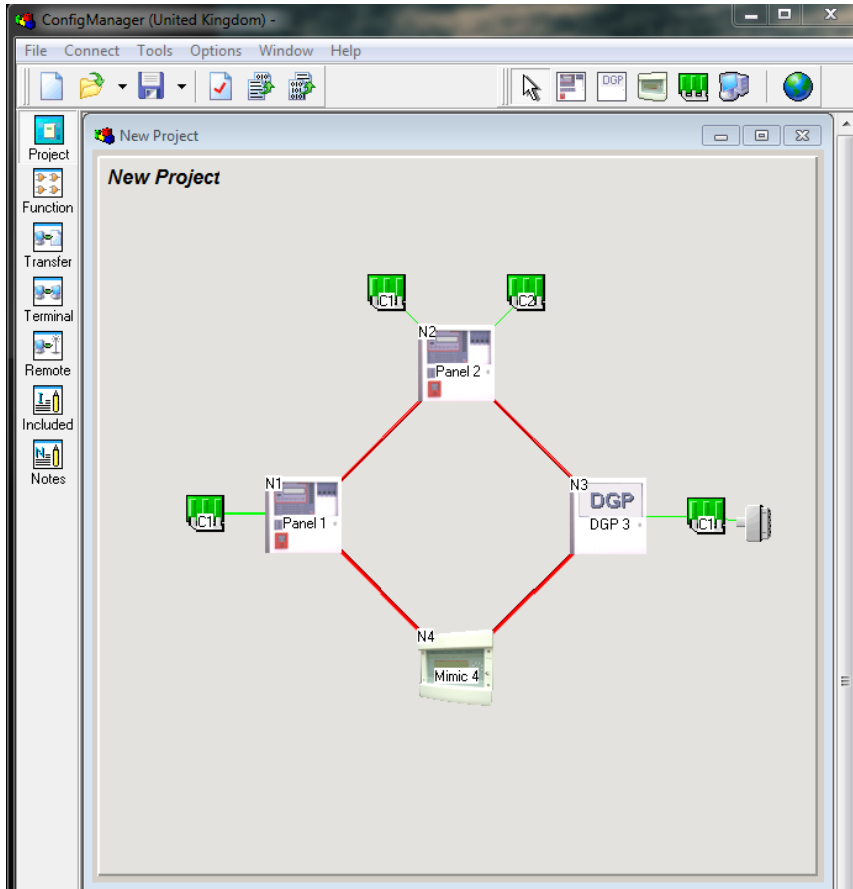

Figure 73: Adding a HLI Depending upon the configuration of the system a HLI may be fitted by left clicking on any controller be it a LCD mimic or Panel. To delete the interface right click on it and select DELETE. In the example shown above we have them fitted to each Controller in the system.

7.5.1 High Level Interface Options (HLI)

The control settings are accessed by double left clicking on the HLI or right clicking and selecting Edit. ***(Bold & Italic notes refer to correspondingly numbered HLI's in the diagram above.)***

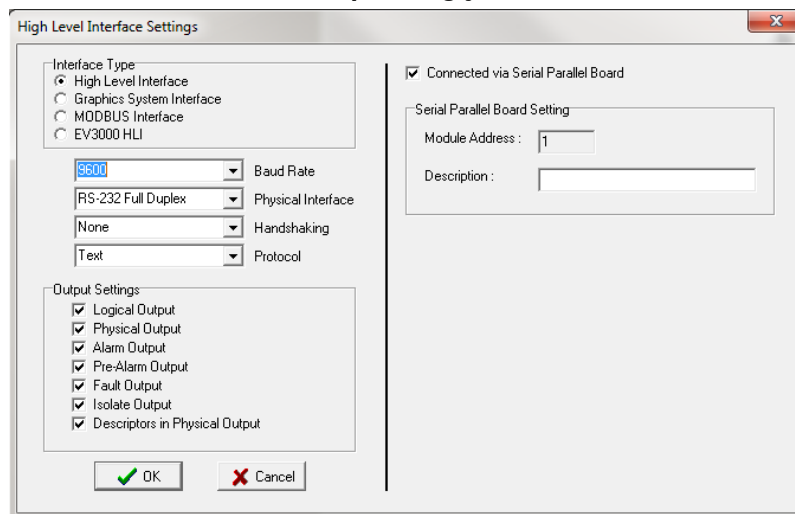

Figure 74: High Level Interface Settings

High Level Interface: Provides a text based output for dumb interfaces like nurse call and paging systems. ***Available to HLI's 1, 2 & 3 above***

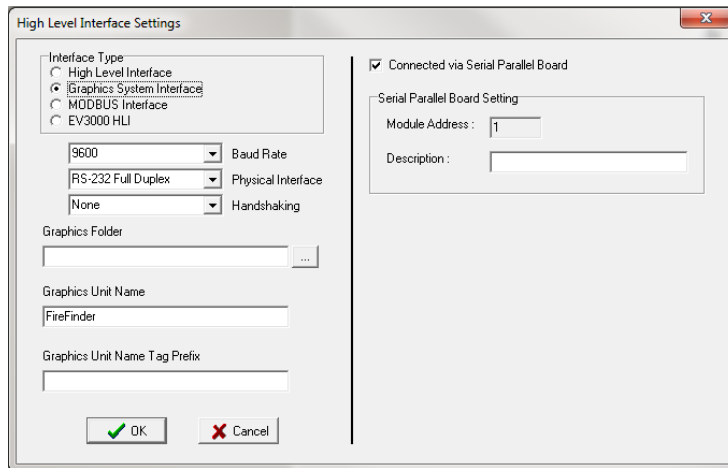

Figure 75: Graphic System Interface Settings

Graphics System Interface: Provides for a 2 way interface for the Ampac SmartGraphics system

Note: Only One Graphic System Interface per Controller

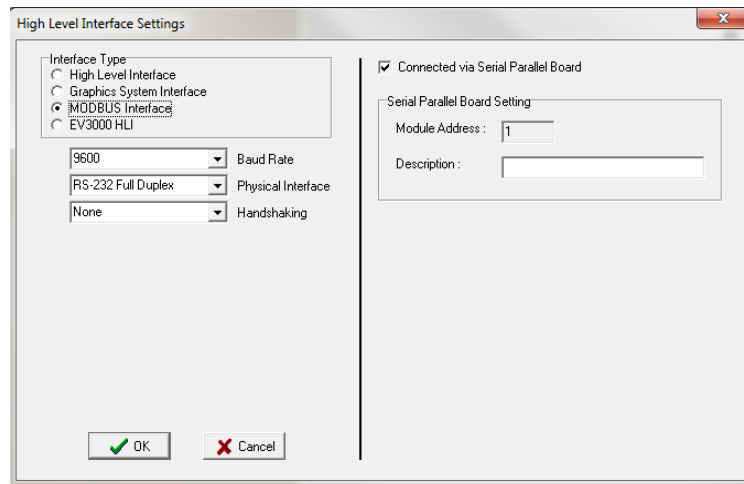

Figure 76: MODBUS Interface Setting

MODBUS Interface: Provides for a 2 way intelligent Modbus RTU standard interface for BMS and PLC based systems

Note: Only One MODBUS Interface per Controller

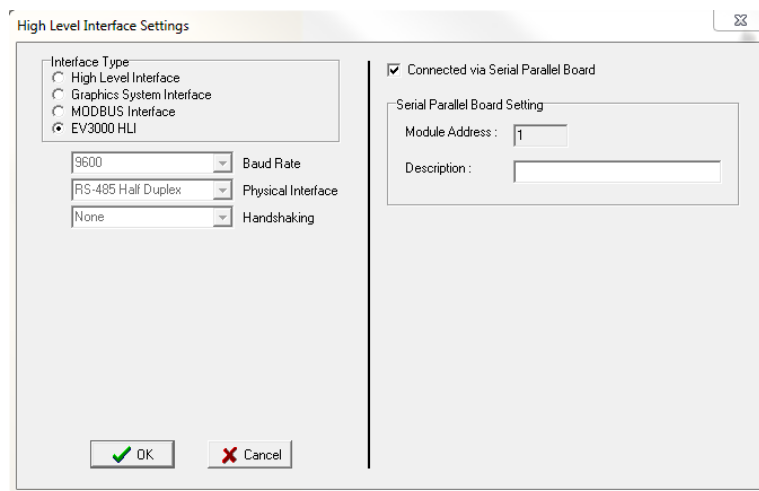

Figure 77: EV3000 HLI Settings

EV3000 HLI: Provides for connection to an AMPAC EV3000 System

Editable Settings for HLI

		2400
		4800
Board Rate:	=	9600
		19200
		38400
Physical Interface:	=	RS232 full Duplex
		RS485 Half Duplex
		None
Handshaking:	=	Hardware RTS / CTS
		Software X on / X off.
		Text
Protocol:	=	Positive Acknowledge
		EWS – EV3000

The HLI is used to output data to external systems such as Building Management Systems (BMS) in a high level serial format.

The BMS interface provides a serial output for the **FireFinder Series II** to announce changes in the state of devices monitored by the **FireFinder Series II**.

Devices can be sensors, zones or groups. A group is a collection of zones and/or sensors.

Sensors can have only one state, i.e. normal, alarm, isolate etc. Zones or groups may have multiple states depending on the state of their individual members. For example if a zone consists of 3 sensors, with one sensor in alarm, one in fault and one isolated, then the zone is said to be in alarm, fault and isolate.

The format of the serial data consists of two sections with an optional third section that MAY include the descriptor string dependant upon whether the descriptor is available with the particular option chosen:

- State of the device, i.e. ALARM, FAULT or ISOLATE.
- ID of the device, i.e. physical or logical.

Descriptor string (as per the descriptor strings entered into the fire panel Max 33 characters)

The state of the device is the new state(s) that the device has assumed.

The logical ID is the ID number of the group the device is assigned. When zones and sensors are configured it is possible to allocate them into groups. These groups may correspond to Evacuation zones or BMS groups or any other group as necessary.

The physical ID is the zone number or loop and sensor number of the field device.

When the interface is configured, it is possible to suppress the logical ID or the physical ID, and to select which state changes the output.

In addition the interface responds to a query command (^E), which causes the **FireFinder Series II** to output the current state of all devices.

7.6 Data Output

The data output consists of a string of characters as detailed:

Format 1: <state1><state2><state3><state4>G<group><cr><lf> (No Descriptor string available)

Format 2: <state1><state2><state3><state4> Z<zone><cr><lf> (Descriptor string available for conventional zones. If a group of sensors share a common zone number but not with a conventional zone then no descriptor is available).

Format 3: <state1><state2><state3><state4> L<loop>S<sensor><cr><lf>> (Descriptor string available for Loop and sensor).

<state1>N = no alarm, A = alarm

<state2>N = no prealarm, P=prealarm

<state3>N = no fault, F = fault

<state4>N = no isolate, I = isolate

G<group>= Group number of the device

Z<zone>= Zone number of the device

L<loop>= Loop number of the device

S<sensor>= Sensor number of the device

<cr> carriage return character (\$0D)

<lf> line feed character (\$0A)

Three options are available to select which formats are used

7.6.1 Option 1 - Physical Output Enabled

Uses **Format 2 or 3**, depending if the device that changes state is a zone or sensor. If a sensor is also "zoned", then if the change in state of that sensor also changes the state of the zone, two updates will be sent, one for the sensor (**Format 3**) and one for the zone (**Format 2**)

>ANNZ5 Zone 5 goes to alarm on the main panel

>NNFNL1S3 Loop 1 sensor 3 into fault

7.6.2 Option 2 - Physical and Logical Output Enabled

Uses Format 1 and 2 or 3.

If a device is not "grouped" then the Format 1 update is not output.

7.6.3 Option 3 - Logical Output Enabled

Uses only **Format 1**.



Note: Ungrouped devices DO NOT cause any output at the BMS module.





Note: in all cases, leading zeros are truncated. All characters are ASCII, with the 8th bit clear.

7.7 Interface Configuration

When the interface is configured, the following options are available:

- Baud Rate – selectable from 1200 to 38400 bits per second
- Output type – RS232 or RS485
- Logical output – enable / disable
- Physical output – enable / disable
- Alarm output – enable / disable
- Pre-alarm output – enable / disable
- Fault output – enable / disable
- Isolate output – enable / disable
- Append descriptor to string (physical output enabled only) – enable / disable
- Output protocol – text only, positive acknowledge or EV3000
- Handshaking – none, hardware (RTS – CTS), software (XON – XOFF)

 **Note:** *Character format is always asynchronous with 1 start bit, 8 data bits, 1 stop bit and no parity.*

 **Note:** *Hardware handshaking only available with RS232 output type.*

 **Note:** *Descriptor strings are only available with physical output, since Groups are not assigned a descriptor string. If a group of sensors are zoned then unless they form part of a conventional zone then no descriptor will be output.*

 **Note:** *Details of the positive acknowledge output protocol available separately*

8 Network Panels

Networked panels are configured in a similar way to an individual panel. In a network each panel is configured with the hardware that is fitted into that particular cabinet (in the same way a stand – alone panel is). The main difference is the access levels that are set for each panel.

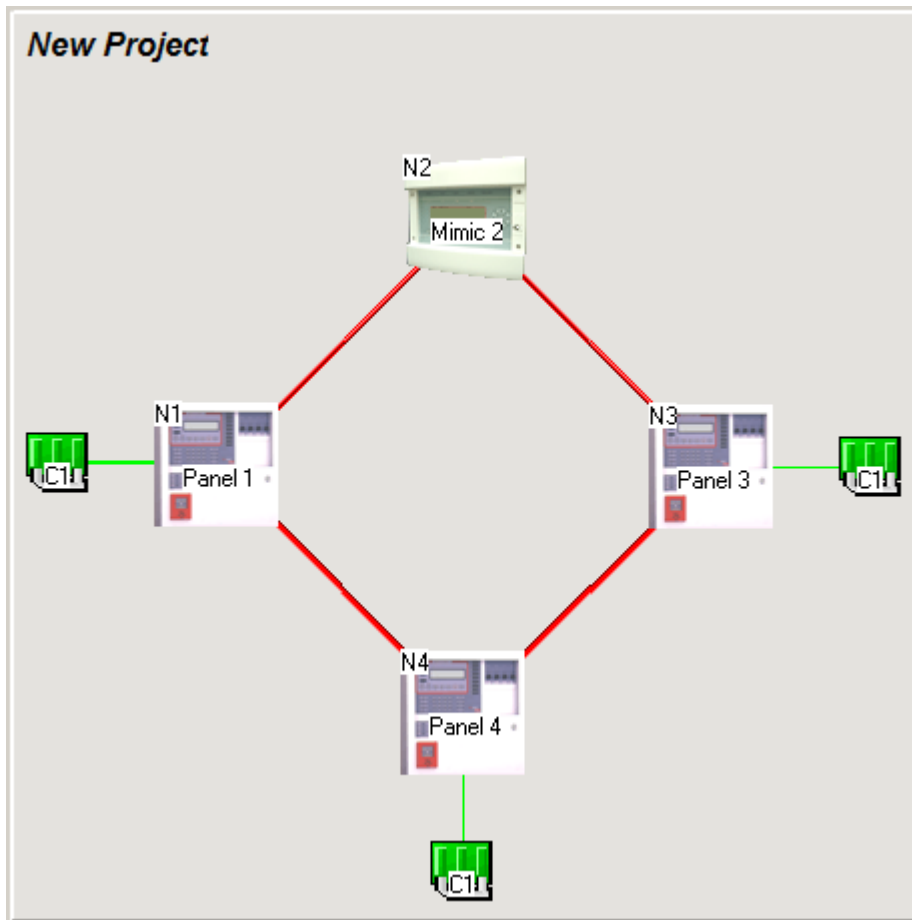
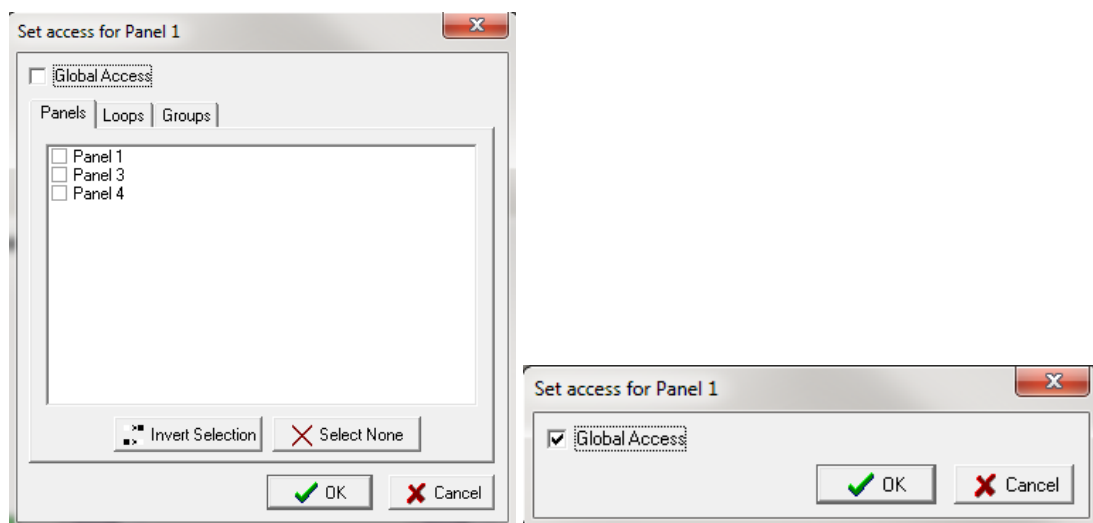

Figure 78: Networked Panels, DGP's, Mimics and Controllers

Again click on each controller to set its parameters. The user will configure the modules in each panel according to what is physically on site. It is normal to configure each panel in order. If this is not done the modules will be automatically assigned module numbers as they are entered. Once all of the zone/sensor information is entered, click on each panel and then set the access levels.



 **Note:** Default access is set to global.

9 Introduction to Programming

The *FireFinder Series II* Fire Alarm Control Panel may be programmed from a computer / laptop either directly or via a modem. This manual outlines a number of programming options available to the operator. There are three areas of software that will be discussed as well as single panel programming and network programming.

All of the software except for the BOOT software is stored in FLASH memory.

The Boot software is stored in EPROMS on the main CPU board.

The EEPROM on board the 302-674 is used to store Controller node address and number, hardware and revision number and debug output control.

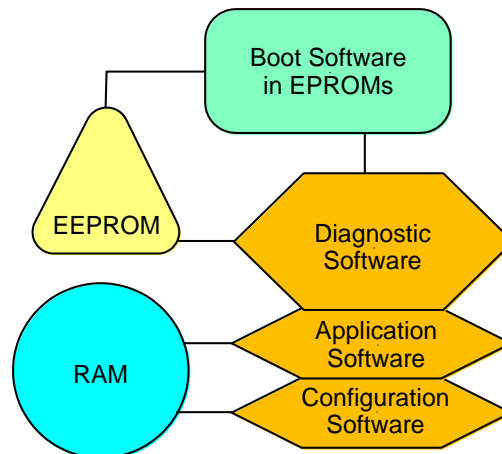

Figure 79: Areas of Software

9.1 Boot Software:

This is the start-up software that the panel uses to start and communicate with the laptop / computer during some of the programming. **This software is stored in EPROM's. In normal operation this software is unlikely to be changed.**

9.2 Application Software:

This is the software that the panel uses to run during normal operation. The application software includes a diagnostic mode to enable the operator to interrogate and control functions of the panel. In normal operation this software is unlikely to be changed.

9.3 Configuration Software:

This is the information (software) that the user down-loads to the panel to enable the panel to identify hardware such as modules and field devices. When a program change is made using the **ConfigManager** program, a data file is created. This data file is then downloaded into the *FireFinder Series II*.

10 Hardware requirements

The **FireFinder Series II** can be configured and updates to the software made via the serial port (RS232) on the Main Board (302-674).

If you are using a PC running Windows you can use AMPAC's ConfigManager program to communicate with the **FireFinder Series II**. Connect the FACP serial port (CN8) to one of the serial ports on your PC

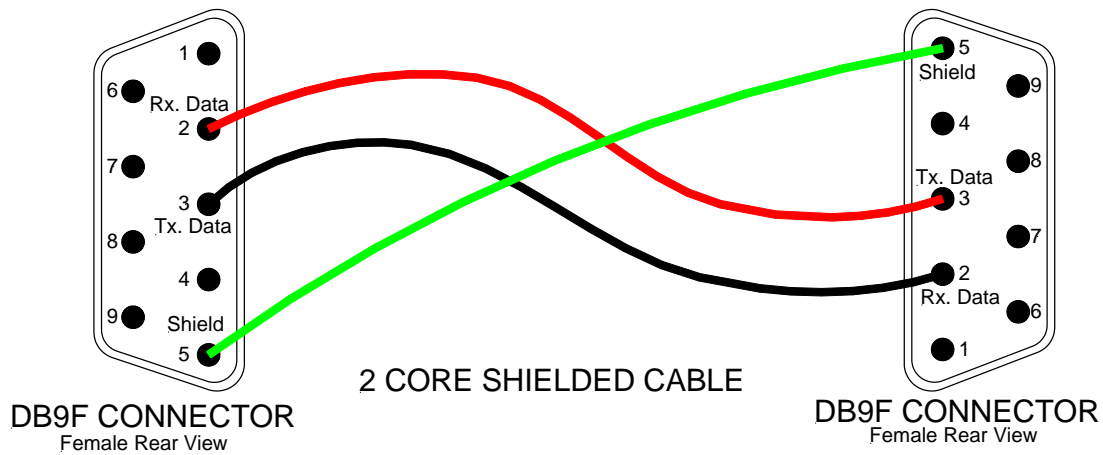
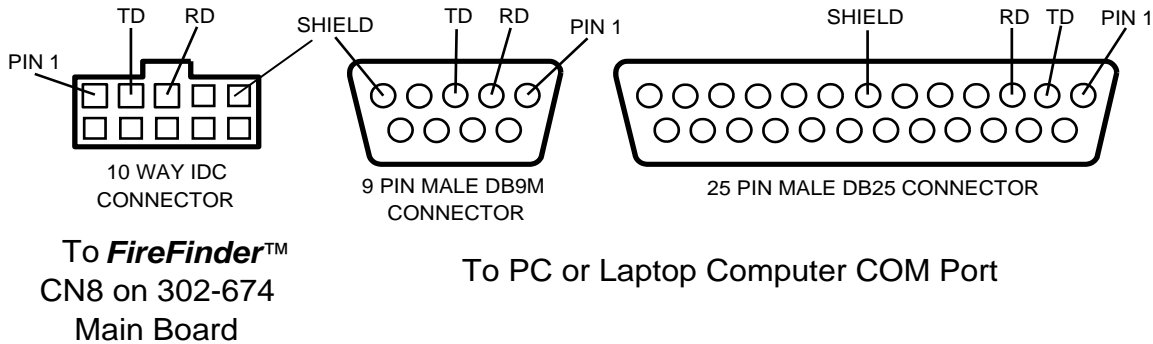

Figure 80: FireFinder Series II Debug Cable Connections

The connector on the: **FireFinder Series II** may be either the 10 way (older versions) or the DB9F connector on later versions, select the one that is appropriate to the system.

Note: the DB9F to DB9F cable is not sensitive to which end is plugged in to the **FireFinder Series II** or serial port of the PC or vice versa.

The connections between the PC/Modem and the panel are crossed. i.e. TD connects to RD.

Make sure the ConfigManager program is set to use the port you have connected the cable to and set up the configuration as follows:

Bits per second:	38400
Data bits:	8
Parity:	None
Stop bits:	1
Flow Control:	None

11 Configuration Programming

There are two methods that may be used to load the software into the FACP. Method 1 uses the "Transfer Wizard" window - Method 2 "uses the Terminal window. The more experienced users tend to use the Terminal window. This requires them to remember commands such as GD etc. For novices using the transfer wizard means that they do not need to remember these commands.

It is good practice to retrieve the configuration data from the panel before doing any programming.

CONNECT YOUR LAPTOP TO THE FIRE FINDER VIA THE DEBUG/MODEM PORT ON THE BACK OF THE PANEL USING THE CORRECT CABLE. (Available from AMPAC)

i IMPORANT!!! *Retrieve the configuration file from the panel before doing any programming. This provides an emergency backup. Save any changes to the configuration file as a different file name.*

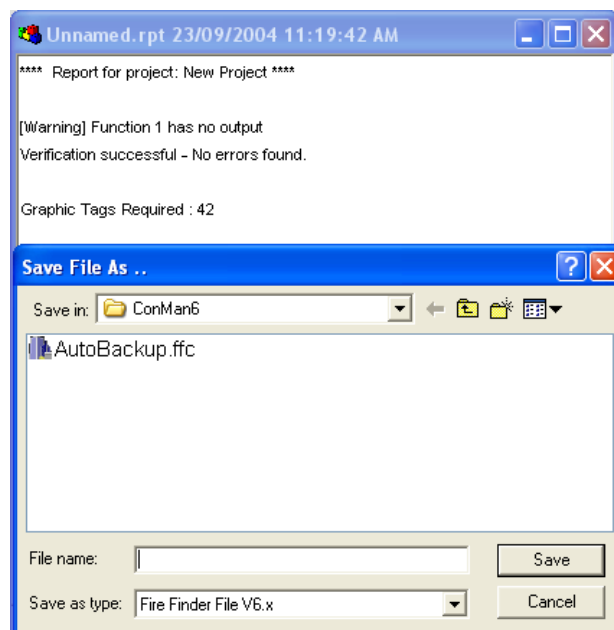
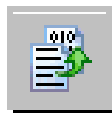
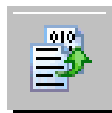

Figure 81: Report and Backup File Creation Screens

Once a configuration has been created and saved;



Compile the file using  or (F5 save created file *.dat). This is the file that is sent to the FACP.

Connect the PC to the FACP and check communications.

11.1 Transfer – Transfer Wizard

Once the Transfer Wizard has established the status of the FACP prompts will guide the operator through the transfer process.

If the Transfer Wizard is unable to establish the state of the FACP an error message will be displayed instructing the operator to “Click ‘Back’ to try again”.

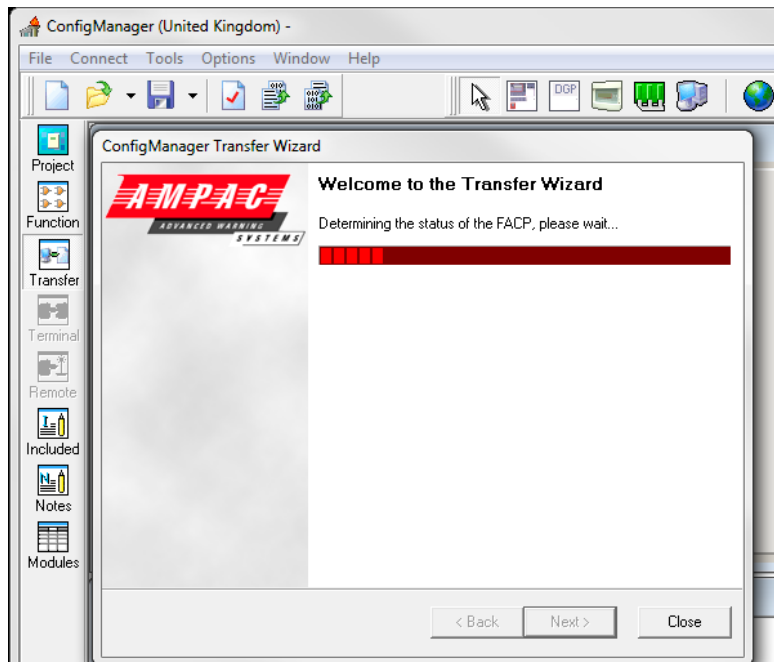

Figure 82: Transfer Wizard Screen

11.1.1 Transfer – Terminal Window

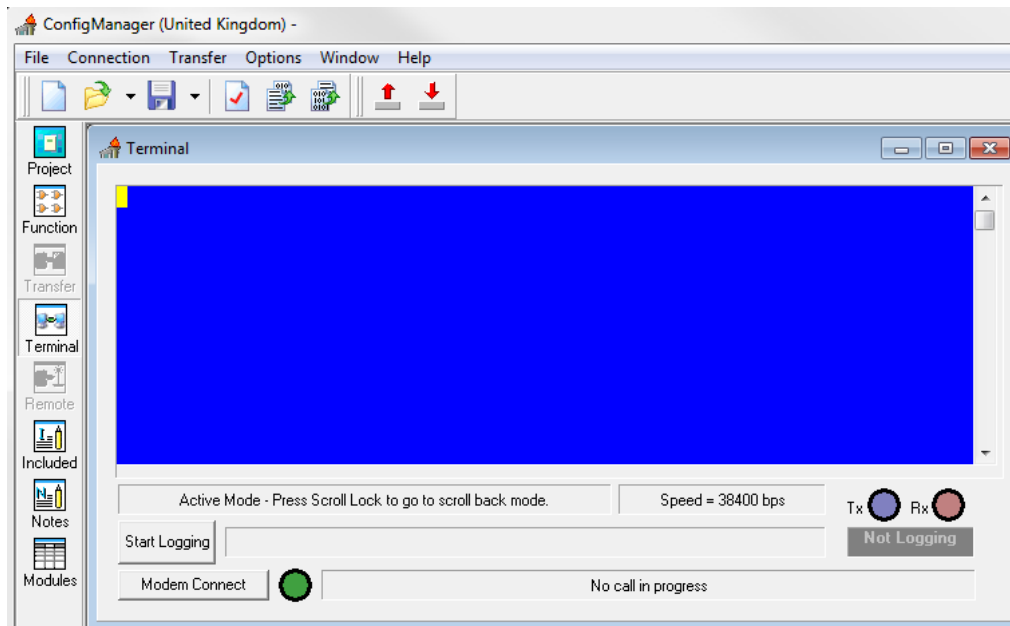

Figure 83: Transfer Screen

The above screen is used when transferring information between the FACP and ConfigManager. In the above example ConfigManager is calling the FACP and the Tx and Rx LEDs would be flashing.



Send File to FireFinder



Receive File from FireFinder

11.2 Uploading

In order for the user to upload or download config software it is necessary for the operator to switch to the diagnostics mode. The normal panel operation is halted in this mode and the display will turn off. The command for this is **gd**. Once this mode has been accessed it is possible to upload a configuration file, select Transfer / Retrieve in **ConfigManager** and receive the respective file.

The panel will send the configuration data to the PC and then the PC will prompt you as to where you want to save the file.

11.3 Changing the Configuration Data in Diagnostics Mode

This mode is the most commonly used mode where an operator will change the configuration software in the panel.

11.4 Installing Configuration Software Using a Computer or Laptop

Using ConfigManager on the laptop (CHECK SETUP)

Once you have compiled and saved the file, using the transfer window in **ConfigManager** connect to the panel.

Pressing the enter button on the computer should cause the panel to return a message

“Ready” This means that the PC is talking to the **FireFinder Series II**. If nothing happens, check your cables and or your computers settings.

Once “Ready” is displayed on the screen you may proceed.

TYPE GD (Go Diagnostics)

Panel will enter the diagnostics mode.

The **FireFinder Series II** should display the current version number and the country/standard code.

In **ConfigManager** there are two red arrows shown on the top menu bar. Using the one that indicates “send file to **FireFinder Series II**” (when you hover over it) select the .dat file you have compiled and saved in the **ConfigManager** program. Send it to the panel by double clicking on the file or by single clicking and pressing OPEN on the dialogue box.

When the panel has received the file it will automatically program its flash memory. The screen should look similar to the following.

Configuration received 1879 bytes

Preparing to program flash, please wait...

Erasing flash... complete.

Program complete

The time to do this will vary according to the size of the downloaded file. In most cases it will be no longer than 30 seconds.

Note: If there are any errors reported then reload the configuration. (If errors are still reported then contact your nearest AMPAC office for assistance.)

Once this is done press enter for “Ready” then type GA (Go Application).

The panel should now automatically restart.

11.5 Boot Mode To Change Application Software

The Boot mode is used to enable the operator to enter the command area (or Boot mode) of the software where it is possible to replace the application software of the panel.

This area should only be accessed when you are replacing the application (or core) software.

TYPE BT (BOOT)

Panel will enter the BOOT mode.

ⓘ CAUTION: *This area allows you to reprogram the application software.*

The application software is software that will have been supplied by AMPAC.

It will be labelled app_Vx.x.xx.xx.bin e.g. app_V6.0.65.69.bin.

To download the software from the PC to the panel select Transfer/Send in **ConfigManager** and send the file. When the file is being transferred to the panel the PC screen will indicate its progress on a dialog box. This will take approximately 5min and 10 sec's.

Once in boot mode the screen will look similar to the following.

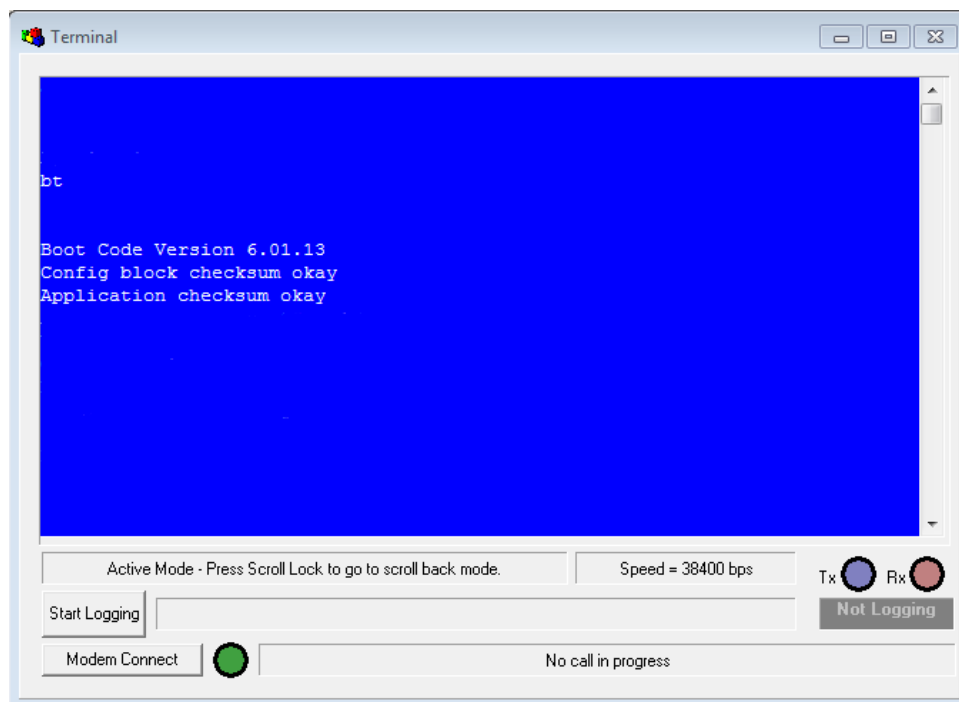

As the data is transferred it is automatically programmed into flash memory. Progress is indicated by a "bar graph" on the LCD display.

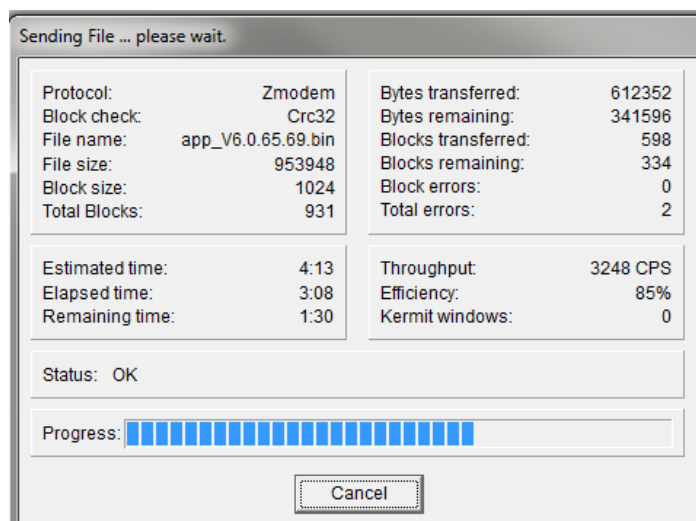

Once programmed successfully the following message will be displayed.

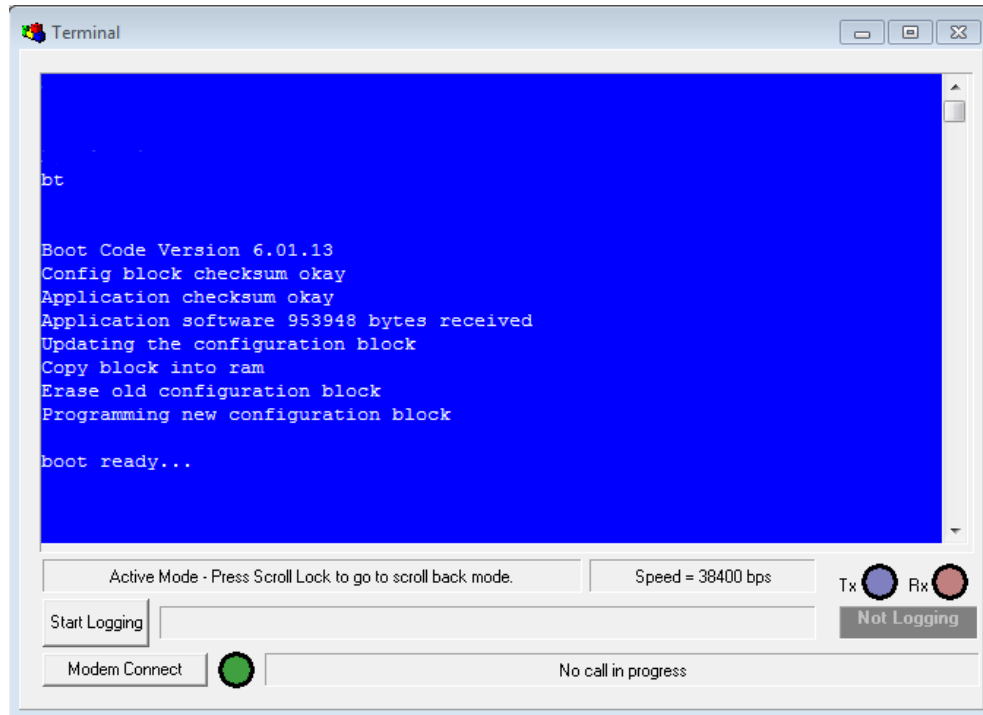

```
bt
Boot Code Version 6.01.13
Config block checksum okay
Application checksum okay
Application software 953948 bytes received
Updating the configuration block
Copy block into ram
Erase old configuration block
Programming new configuration block
boot ready...
```

Active Mode - Press Scroll Lock to go to scroll back mode. Speed = 38400 bps Tx Rx Not Logging

Start Logging

Modem Connect No call in progress

Ensure that there are no errors when the messages are displayed. If there are errors reported re-load the software.

Once the software has been successfully programmed into FLASH then the panel is returned to the Diagnostics mode by typing **GD** (Go Diagnostics).

Typically it will look similar to the message below

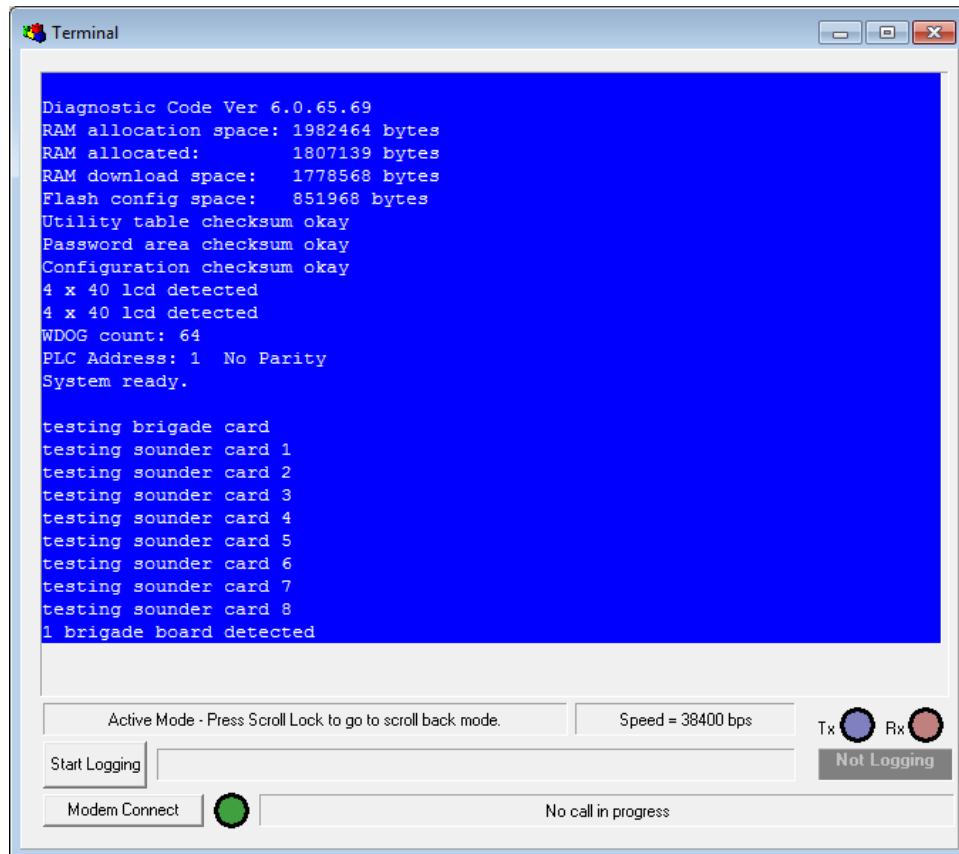

```
Diagnostic Code Ver 6.0.65.69
RAM allocation space: 1982464 bytes
RAM allocated: 1807139 bytes
RAM download space: 1778568 bytes
Flash config space: 851968 bytes
Utility table checksum okay
Password area checksum okay
Configuration checksum okay
4 x 40 lcd detected
4 x 40 lcd detected
WDOG count: 64
PLC Address: 1 No Parity
System ready.

testing brigade card
testing sounder card 1
testing sounder card 2
testing sounder card 3
testing sounder card 4
testing sounder card 5
testing sounder card 6
testing sounder card 7
testing sounder card 8
1 brigade board detected
```

Active Mode - Press Scroll Lock to go to scroll back mode. Speed = 38400 bps Tx Rx Not Logging

Start Logging

Modem Connect No call in progress

From here if the configuration data has been programmed then type **GA** (Go Application) and the panel should re-boot.

If the system is OK then the message displayed should be similar to below but considerably longer.

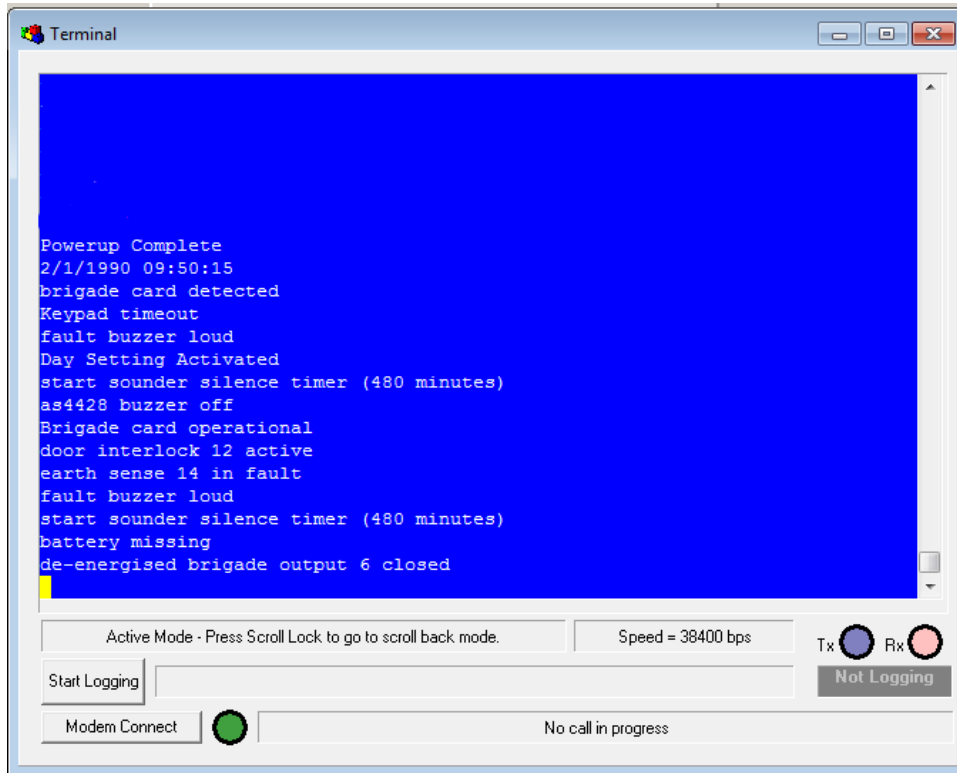

```
Terminal
Powerup Complete
2/1/1990 09:50:15
brigade card detected
Keypad timeout
fault buzzer loud
Day Setting Activated
start soulder silence timer (480 minutes)
as4428 buzzer off
Brigade card operational
door interlock 12 active
earth sense 14 in fault
fault buzzer loud
start soulder silence timer (480 minutes)
battery missing
de-energised brigade output 6 closed
```

Active Mode - Press Scroll Lock to go to scroll back mode. Speed = 38400 bps Tx Rx

Start Logging Not Logging

Modem Connect No call in progress

11.6 Using a Modem

You can communicate with the *FireFinder Series II* over a modem using HyperTerminal or any number of communication packages. Install the modem on your computer as instructed by the modem manufacturer. In HyperTerminal, under File/Properties, instead of selecting a port (Connect using), select the modem. Ensure that the phone number to ring is the number for the line connected to the *FireFinder Series II*'s modem.

At the *FireFinder Series II* end you will need to connect CN8 on the 302-674 to a modem. The connections will be the same as shown in Fig 67.

Starting the HyperTerminal session will ring the modem on the panel, once a connection has been made all the commands are the same as if making a direct cable connection. Once the connection is made to the *FireFinder Series II*, press enter in HyperTerminal and the screen should display:

“Ready” If nothing happens, check your cables.

If the *FireFinder Series II* is currently running it will be in Application Mode.

Make sure HyperTerminal is set to use the port you have connected the cable to and set up the configuration as follows

- Bits per second: 19200
- Data bits: 8
- Parity: None
- Stop bits: 1
- Flow Control: None

11.7 Wireless Modem

FireFinder Series II may also be programmed via a wireless modem.

12 Network Programming

Single Point Programming *FireFinder Series II* is the term AMPAC uses to describe the method by which the network is programmed from one point. It is most important to follow these steps to ensure trouble free network programming.

12.1 Part 1: Upgrading the Configuration

Before attempting network programming from a single point you should first check the communications loop and make sure that all panels are operating normally. It is also essential that all panels on the loop contain a valid configuration and address for the network that they are connected to. All of the following points refer to commands issued from either a laptop or PC.

It is recommended that all SP programming be carried out from Node 1 (the main panel).



Note: If the panel fails to operate or respond correctly after reprogramming then there are a number of possibilities as to what has caused the problem. See the troubleshooting section for remedies.

12.2 State of the Network

Establish the state of the Network and ensure the loop is good using the QP (Query Points) command:

QP

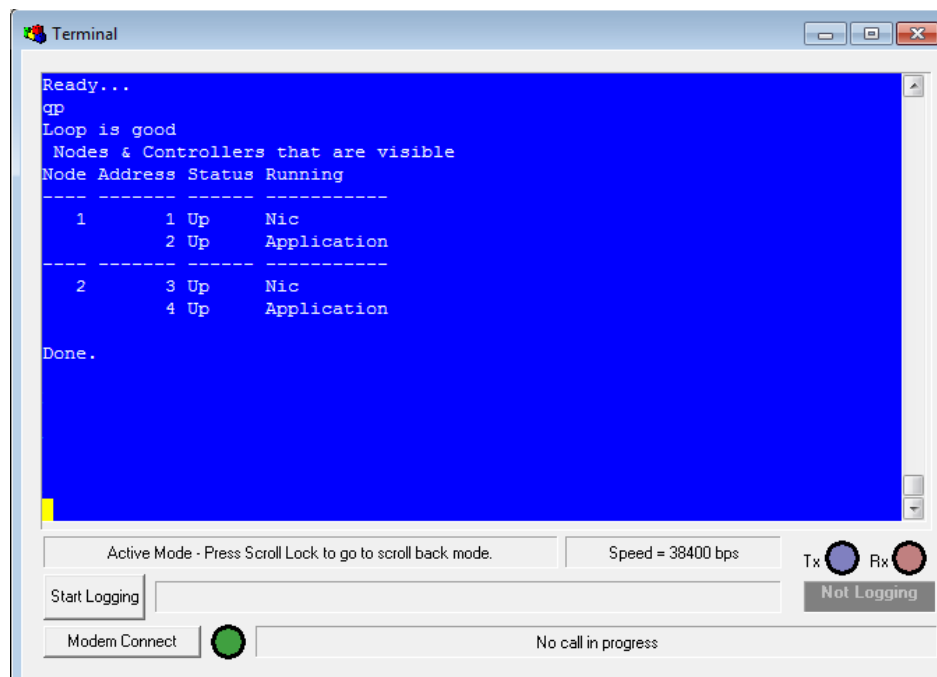

```
Terminal
Ready...
qp
Loop is good
Nodes & Controllers that are visible
Node Address Status Running
-----
1      1  Up   Nic
      2  Up   Application
-----
2      3  Up   Nic
      4  Up   Application
Done.
```

Active Mode - Press Scroll Lock to go to scroll back mode. Speed = 38400 bps Tx Rx Not Logging Modem Connect No call in progress

Bring the entire system back to diagnostic mode to enable the config to be programmed by using the NGD (Network Go Diagnostic) command:

12.3 Network Go Diagnostic (NGD)

This command causes the entire network to enter the Diagnostic state.

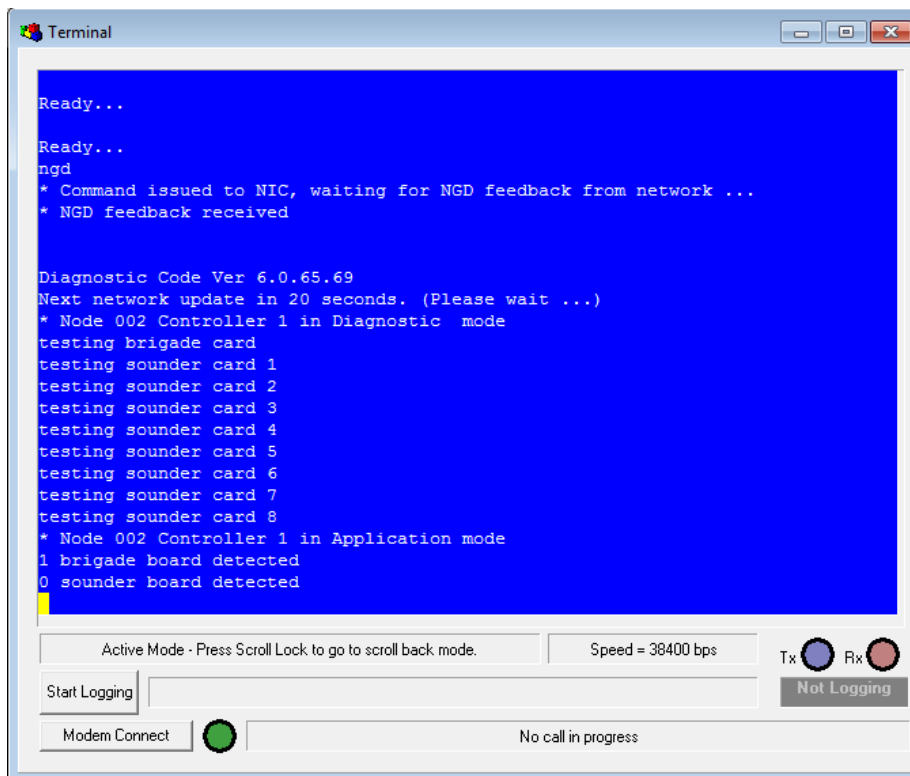

```

Terminal
Ready...
Ready...
ngd
* Command issued to NIC, waiting for NGD feedback from network ...
* NGD feedback received

Diagnostic Code Ver 6.0.65.69
Next network update in 20 seconds. (Please wait ...)
* Node 002 Controller 1 in Diagnostic mode
testing brigade card
testing sounder card 1
testing sounder card 2
testing sounder card 3
testing sounder card 4
testing sounder card 5
testing sounder card 6
testing sounder card 7
testing sounder card 8
* Node 002 Controller 1 in Application mode
1 brigade board detected
0 sounder board detected
  
```

QP

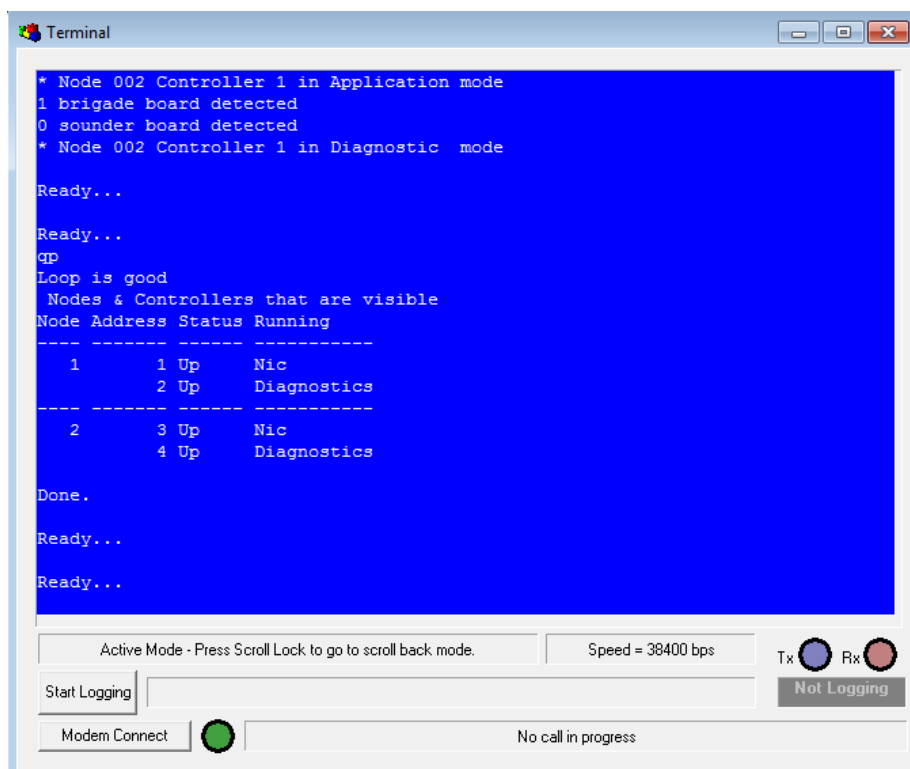

```

Terminal
* Node 002 Controller 1 in Application mode
1 brigade board detected
0 sounder board detected
* Node 002 Controller 1 in Diagnostic mode

Ready...
Ready...
qp
Loop is good
Nodes & Controllers that are visible
Node Address Status Running
-----
1      1 Up    Nic
      2 Up    Diagnostics
-----
2      3 Up    Nic
      4 Up    Diagnostics
-----

Done.

Ready...
Ready...
  
```

 **Note:** THIS IS MOST IMPORTANT THAT ALL OF THE PANELS ARE IN THIS MODE. If they are not then it is likely that the panels are not communicating. This must be corrected before proceeding.

Once the panels are all in diagnostic mode proceed as below.

Send the new config to the panel to which you are connected using your communication package file transfer as you would normally:

It is important to take note of the output during programming and make sure that no errors are reported.

Once this is done the host panel has been programmed with the latest configuration.

Send the configuration around the network using the NSC (Network Send Configuration) command:

NSC

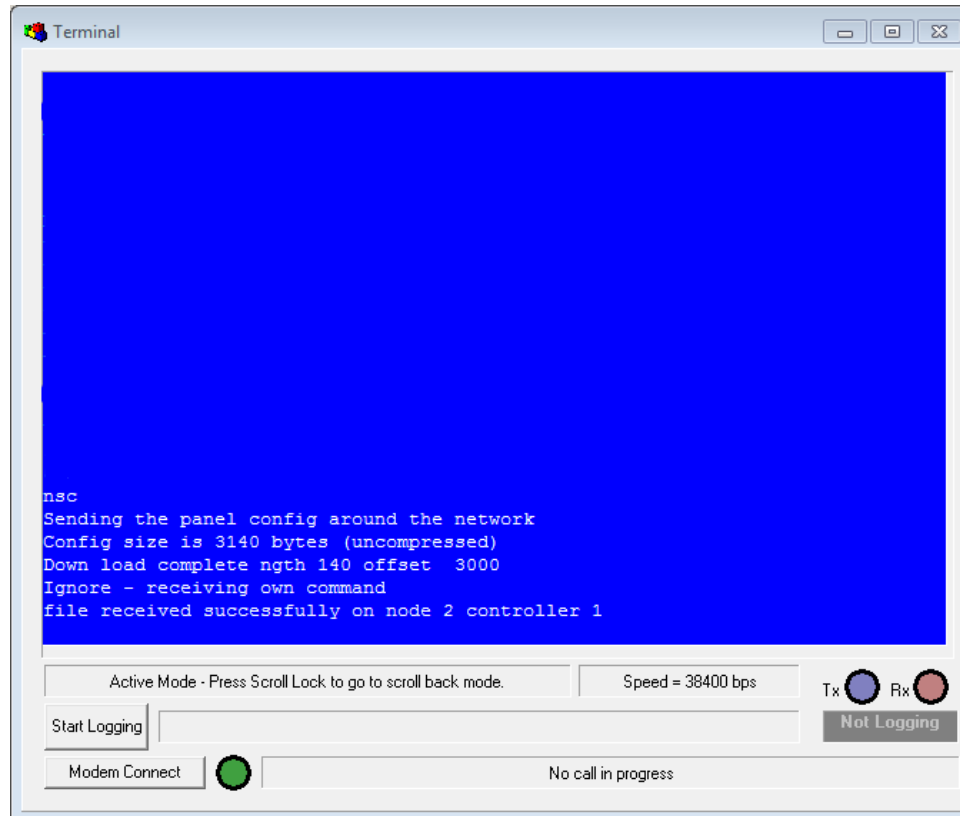

```
Terminal
nsc
Sending the panel config around the network
Config size is 3140 bytes (uncompressed)
Down load complete ngth 140 offset 3000
Ignore - receiving own command
file received successfully on node 2 controller 1
```

Active Mode - Press Scroll Lock to go to scroll back mode. Speed = 38400 bps Tx Rx Not Logging

Start Logging

Modem Connect No call in progress

When you enter the **NSC** command the “Sending Panel Config” dialogue will appear and the offset will increase in value until it reaches the Config Size.

At this point the “Down Load Complete” message will appear as well as file received confirmations for each controller on the network. It is important that you receive one of these messages from each controller (except the one that you are programming from) on the system before proceeding to the next step.

Program the panels around the network using the **NPC** (Network Program Configuration) command:

NPC

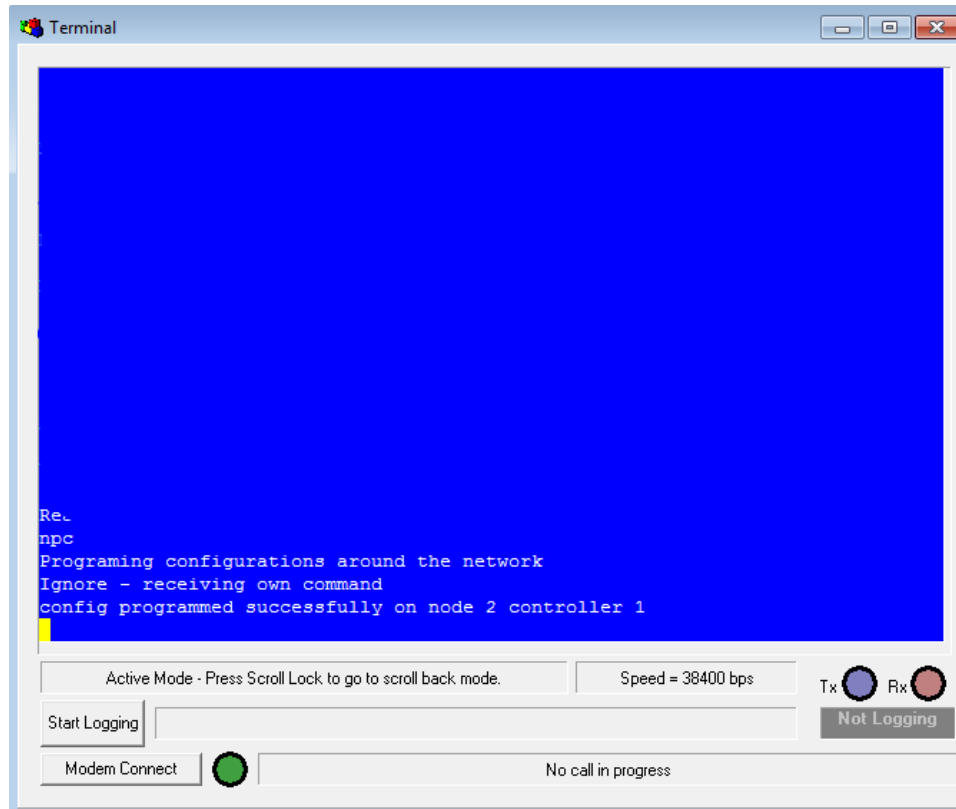

```
Terminal
Rec
npc
Programming configurations around the network
Ignore - receiving own command
config programmed successfully on node 2 controller 1
```

Active Mode - Press Scroll Lock to go to scroll back mode. Speed = 38400 bps Tx Rx Not Logging

Start Logging

Modem Connect No call in progress

A short time after entering the **NPC** command you should receive a “programmed successfully” message for each controller (except the one that you are programming from).

The system is now programmed and ready to be re-started using the **NGA** (Network Go Application) command:

nga

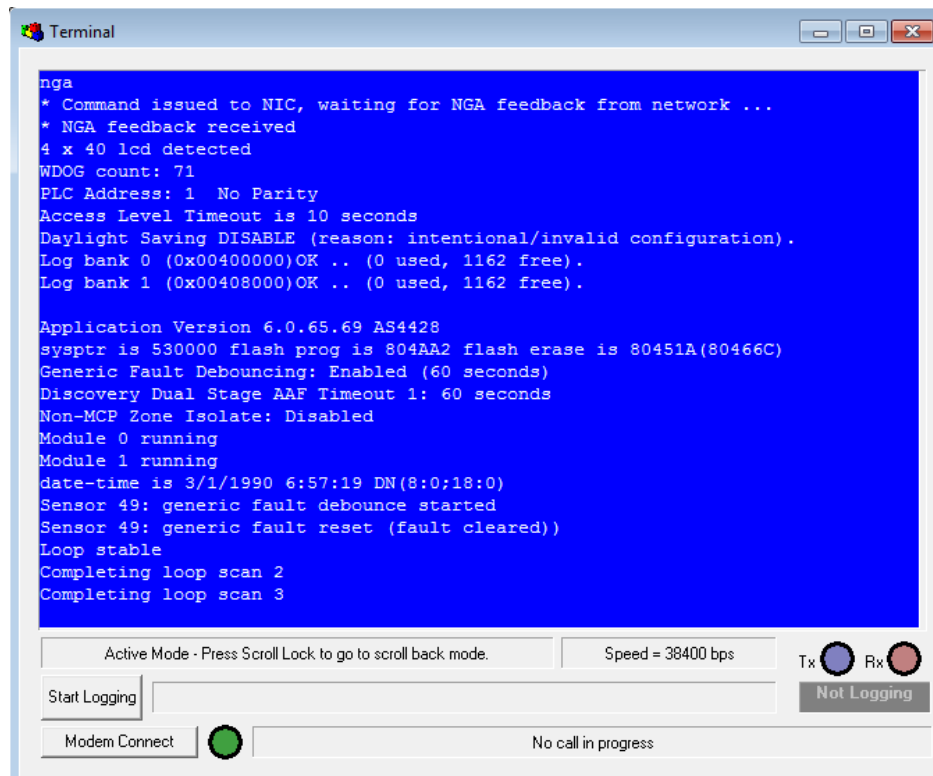

```
Terminal
nga
* Command issued to NIC, waiting for NGA feedback from network ...
* NGA feedback received
4 x 40 lcd detected
WDOG count: 71
PLC Address: 1 No Parity
Access Level Timeout is 10 seconds
Daylight Saving DISABLE (reason: intentional/invalid configuration).
Log bank 0 (0x00400000)OK .. (0 used, 1162 free).
Log bank 1 (0x00408000)OK .. (0 used, 1162 free).

Application Version 6.0.65.69 AS4428
sysptr is 530000 flash prog is 804AA2 flash erase is 80451A(80466C)
Generic Fault Debouncing: Enabled (60 seconds)
Discovery Dual Stage AAF Timeout 1: 60 seconds
Non-MCP Zone Isolate: Disabled
Module 0 running
Module 1 running
date-time is 3/1/1990 6:57:19 DN(8:0;18:0)
Sensor 49: generic fault debounce started
Sensor 49: generic fault reset (fault cleared)
Loop stable
Completing loop scan 2
Completing loop scan 3
```

Active Mode - Press Scroll Lock to go to scroll back mode. Speed = 38400 bps Tx Rx Not Logging

Start Logging

Modem Connect No call in progress

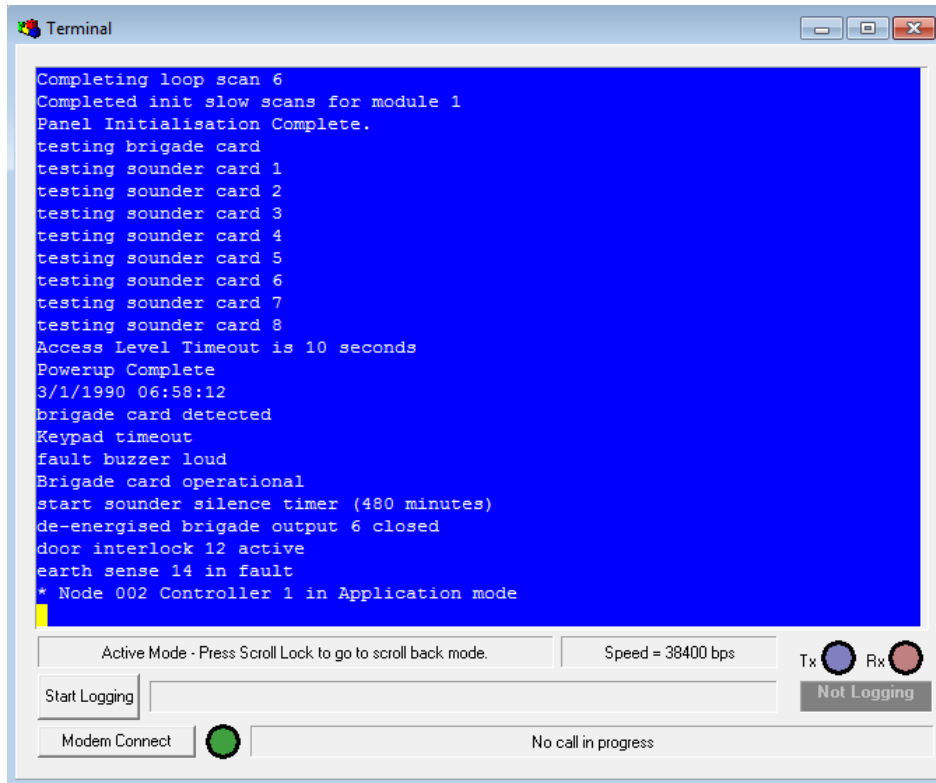

Once the system power up is complete use the QP command to verify that all nodes and controllers are operational:

QP

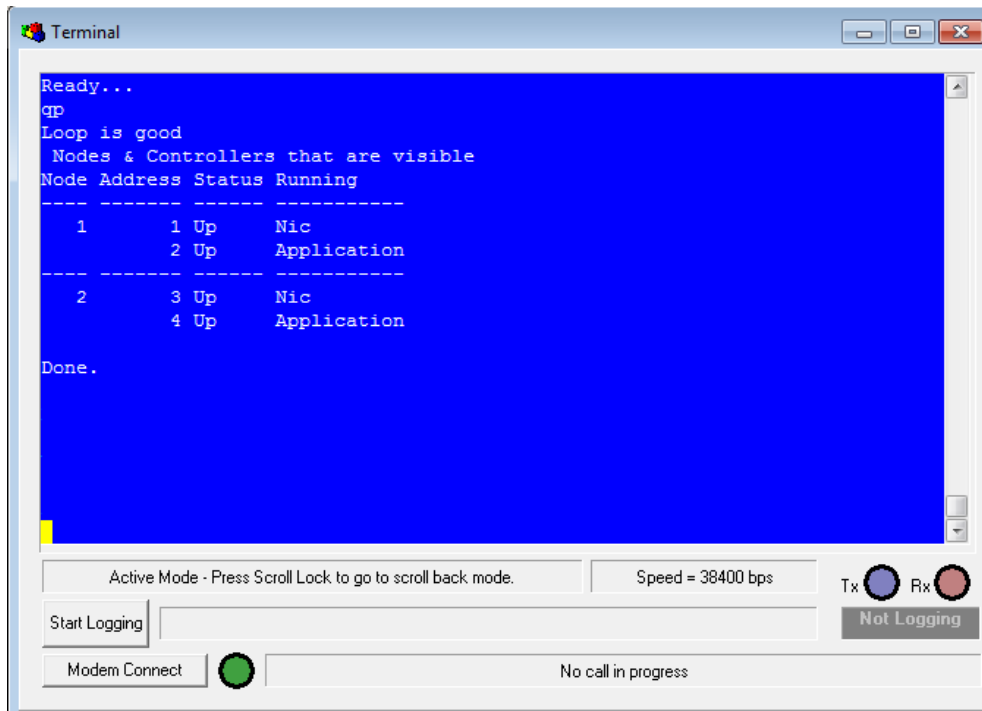

12.4 Part 2: Upgrading the Application



Note: If a system is to be upgraded to version 6 from an earlier version then the panels have to be upgraded individually. **THIS INCLUDES BOOT ROMs**

Before attempting network programming from a single point you should first check the communications loop and make sure that all panels are operating normally. It is also essential that all panels on the loop contain a valid configuration and address for the network that they are connected to.

It is recommended that all SP programming be carried out from Node 1 (the main panel).

Establish the state of the Network and ensure the loop is good using the QP (Query Points) command:

QP

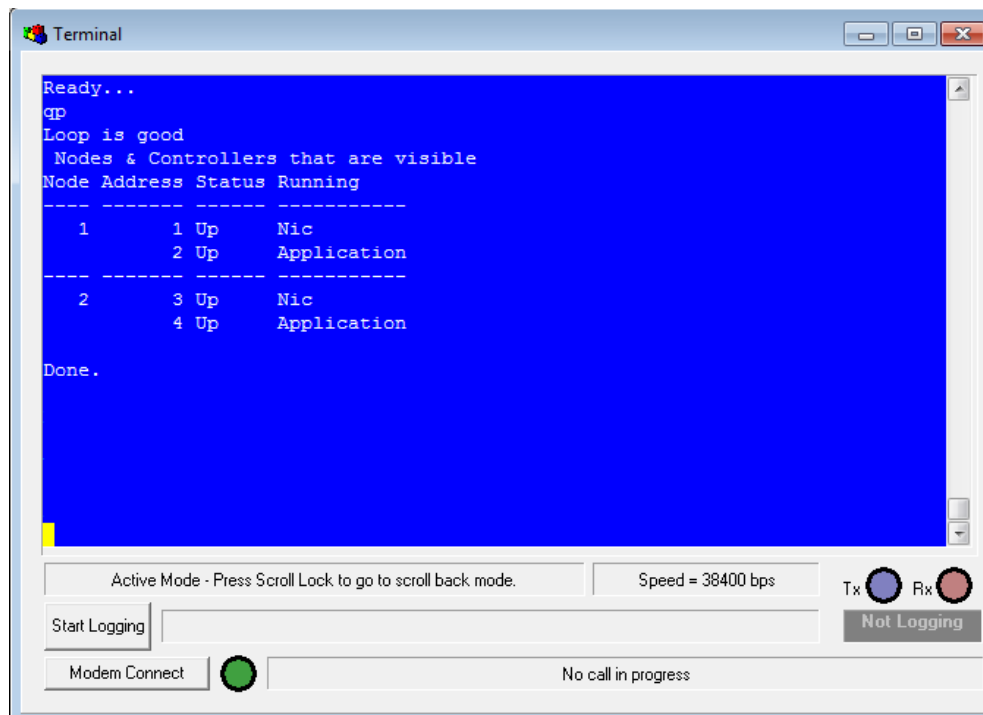

```
Terminal
Ready...
qp
Loop is good
Nodes & Controllers that are visible
Node Address Status Running
-----
1      1    Up    Nic
      2    Up    Application
-----
2      3    Up    Nic
      4    Up    Application
Done.
```

Active Mode - Press Scroll Lock to go to scroll back mode. Speed = 38400 bps Tx Rx Not Logging

Start Logging

Modem Connect No call in progress

Bring the entire system back to diagnostic mode by using the **NGD** (Network Go Diagnostic) command:

NGD

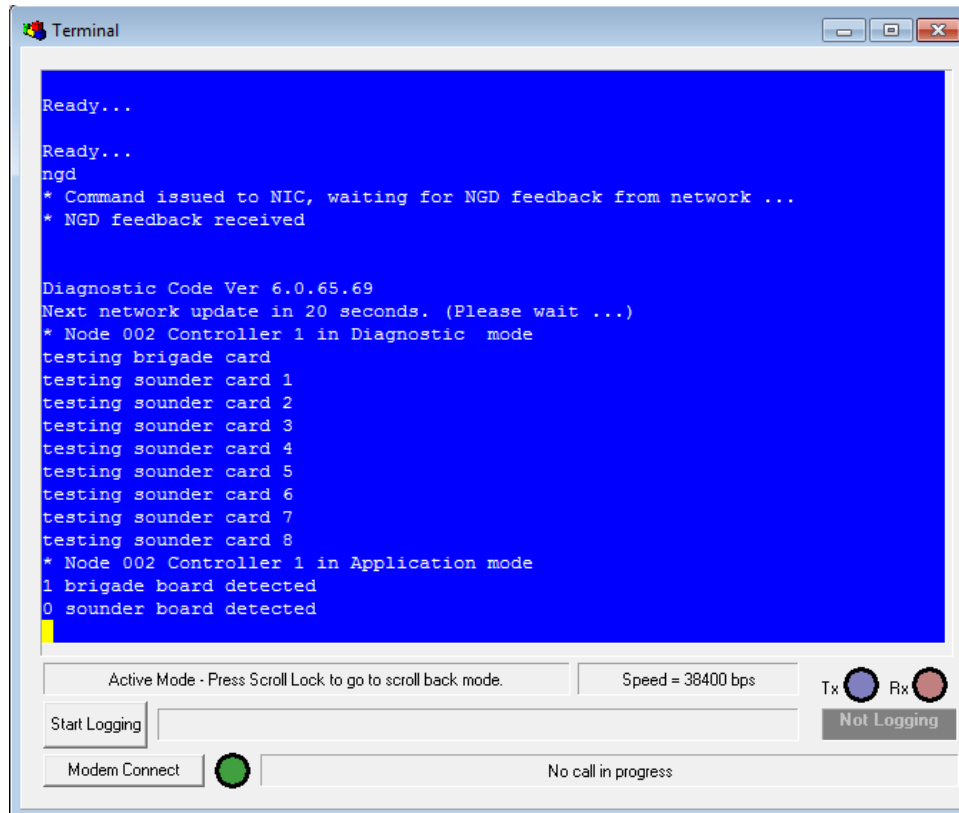

```

Terminal
Ready...
Ready...
ngd
* Command issued to NIC, waiting for NGD feedback from network ...
* NGD feedback received

Diagnostic Code Ver 6.0.65.69
Next network update in 20 seconds. (Please wait ...)
* Node 002 Controller 1 in Diagnostic mode
testing brigade card
testing sounder card 1
testing sounder card 2
testing sounder card 3
testing sounder card 4
testing sounder card 5
testing sounder card 6
testing sounder card 7
testing sounder card 8
* Node 002 Controller 1 in Application mode
1 brigade board detected
0 sounder board detected
  
```

Active Mode - Press Scroll Lock to go to scroll back mode. Speed = 38400 bps Tx Rx

Start Logging Not Logging

Modem Connect No call in progress

This command may take up to 30 seconds to complete on a larger network.

Check the status of the system using the **QP** command:

QP

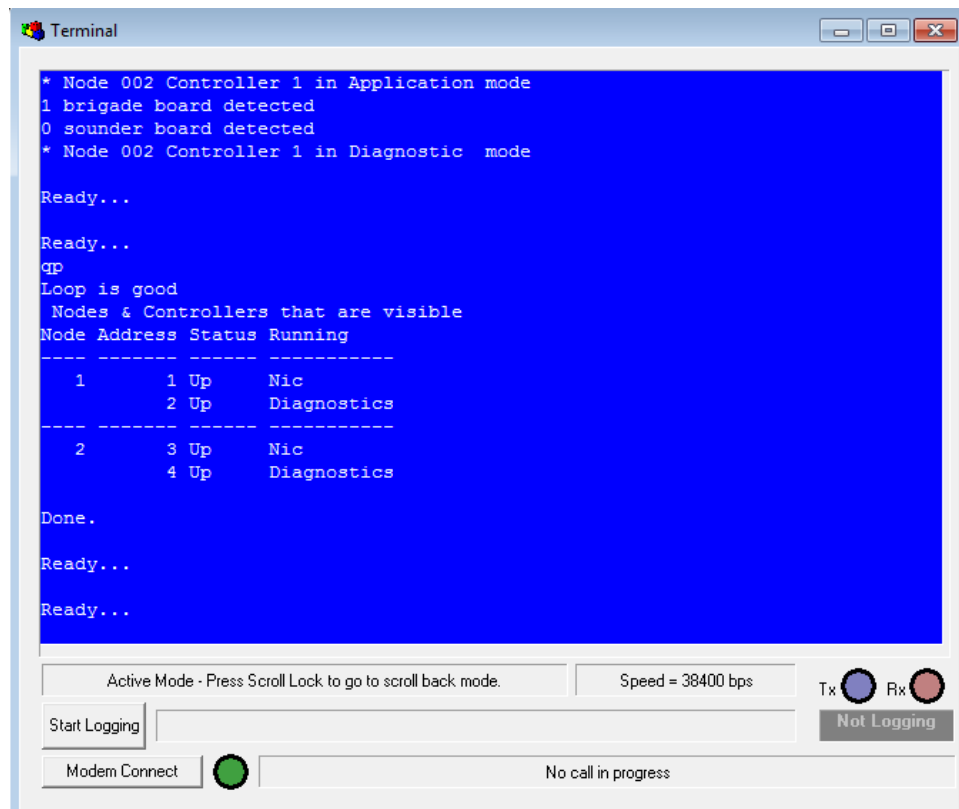

```

Terminal
* Node 002 Controller 1 in Application mode
1 brigade board detected
0 sounder board detected
* Node 002 Controller 1 in Diagnostic mode

Ready...
Ready...
QP
Loop is good
Nodes & Controllers that are visible
Node Address Status Running
-----
1      1 Up    Nic
      2 Up    Diagnostics
-----
2      3 Up    Nic
      4 Up    Diagnostics
-----

Done.
Ready...
Ready...
  
```

Active Mode - Press Scroll Lock to go to scroll back mode. Speed = 38400 bps Tx Rx

Start Logging Not Logging

Modem Connect No call in progress

BT

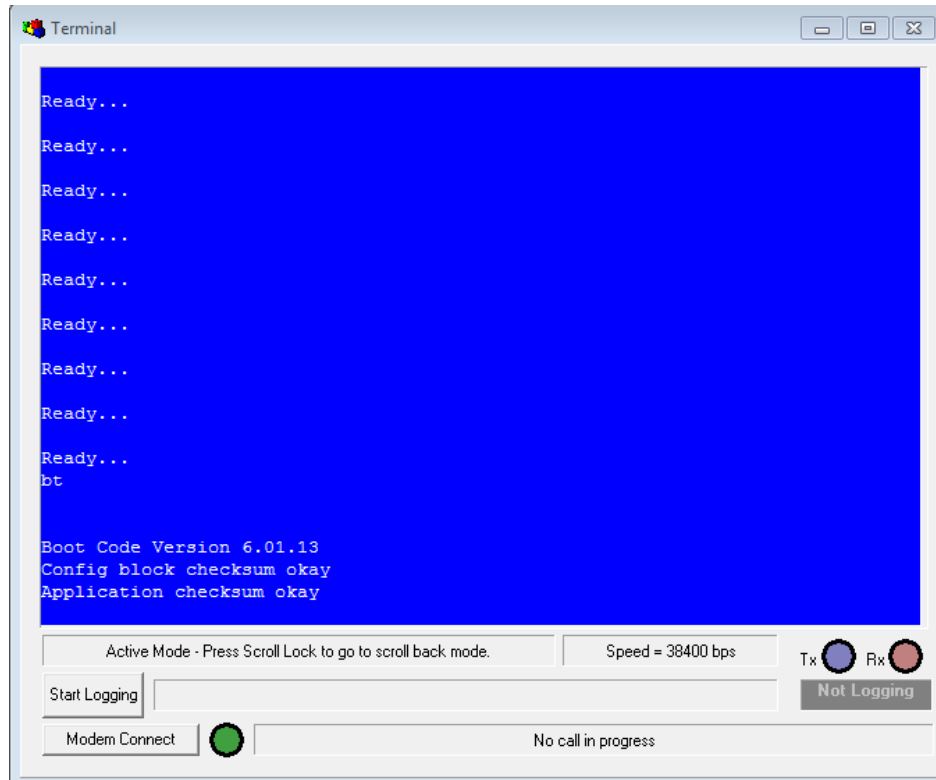

Send the new application to the panel using your communication package file transfer as you would normally:

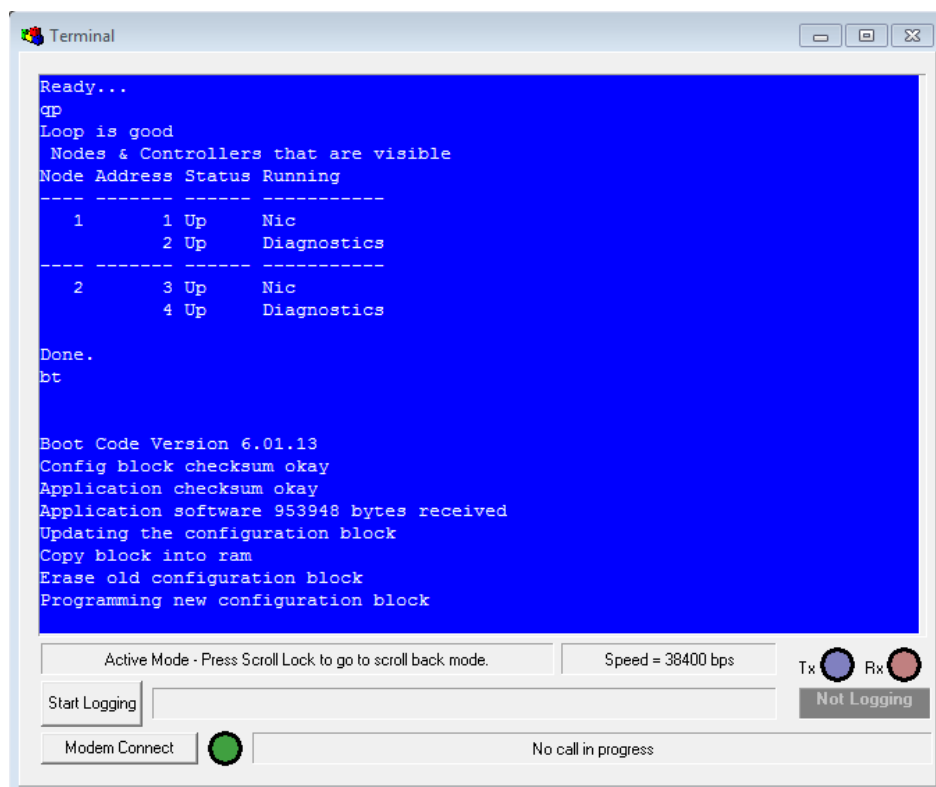

It is important to take note of the output during programming and make sure that no errors are reported.

Bring the local panel back to diagnostic mode using the **GD** (Go Diagnostic) command:

GD

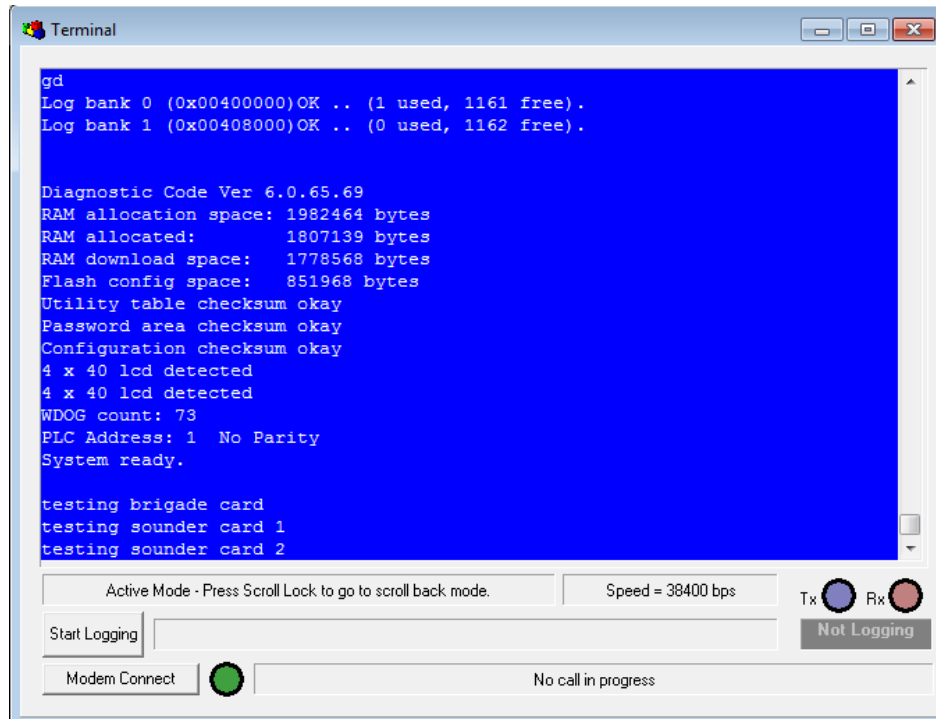

```

gd
Log bank 0 (0x00400000)OK .. (1 used, 1161 free).
Log bank 1 (0x00408000)OK .. (0 used, 1162 free).

Diagnostic Code Ver 6.0.65.69
RAM allocation space: 1982464 bytes
RAM allocated:      1807139 bytes
RAM download space: 1778568 bytes
Flash config space: 851968 bytes
Utility table checksum okay
Password area checksum okay
Configuration checksum okay
4 x 40 lcd detected
4 x 40 lcd detected
WDOG count: 73
PLC Address: 1 No Parity
System ready.

testing brigade card
testing sounder card 1
testing sounder card 2

```

Active Mode - Press Scroll Lock to go to scroll back mode. Speed = 38400 bps Tx Rx Not Logging

Start Logging

Modem Connect No call in progress

Check the status of the system using the **QP** command:

QP

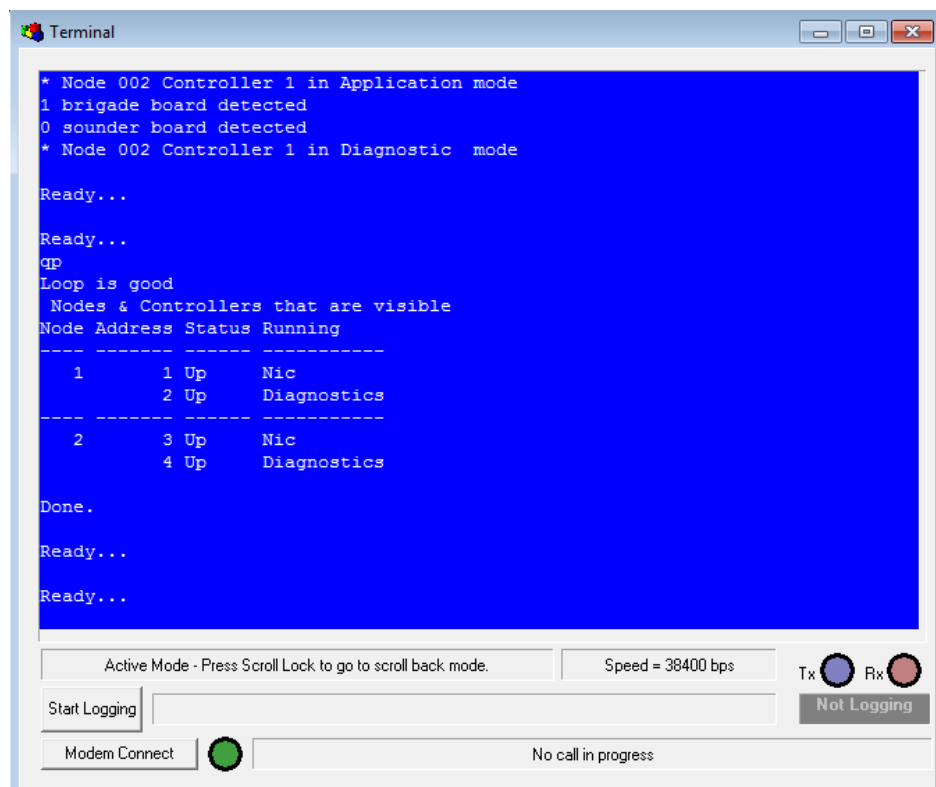

```

* Node 002 Controller 1 in Application mode
1 brigade board detected
0 sounder board detected
* Node 002 Controller 1 in Diagnostic mode

Ready...

Ready...
QP
Loop is good
Nodes & Controllers that are visible
Node Address Status Running
-----
  1      1 Up    Nic
        2 Up    Diagnostics
-----
  2      3 Up    Nic
        4 Up    Diagnostics

Done.

Ready...

Ready...

```

Active Mode - Press Scroll Lock to go to scroll back mode. Speed = 38400 bps Tx Rx Not Logging

Start Logging

Modem Connect No call in progress

 **Note:** THIS IS MOST IMPORTANT THAT ALL OF THE PANELS ARE IN THIS MODE. If they are not then it is likely that the panels are not communicating. This must be corrected before proceeding.

Once the panels are all in diagnostic mode proceed as below.

Send the application around the network using the **NSA** (Network Send Application) command:

NSA

Sending the application software around the network

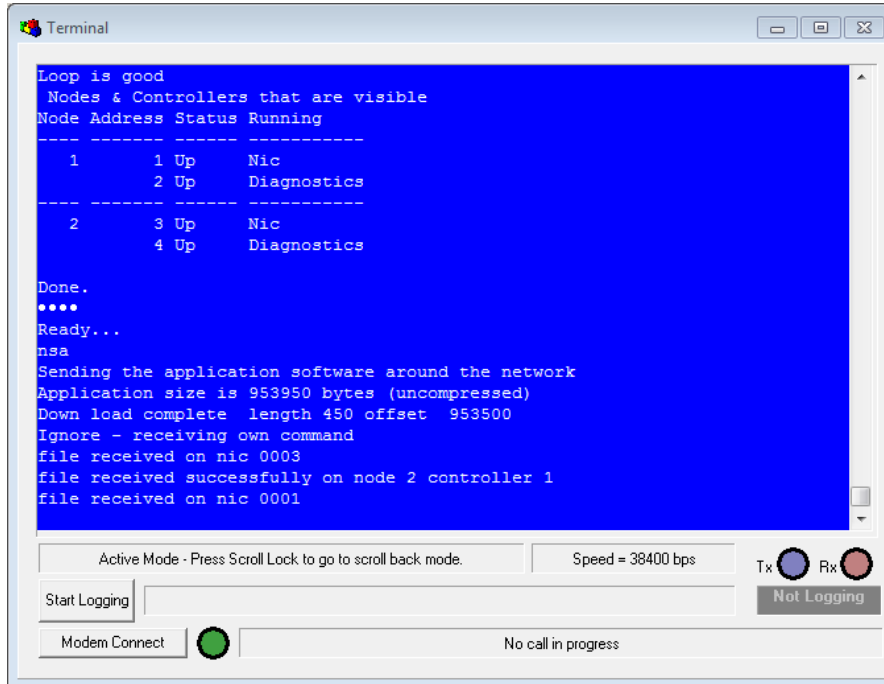

```

Terminal
Loop is good
Nodes & Controllers that are visible
Node Address Status Running
-----
1      1 Up      Nic
      2 Up      Diagnostics
-----
2      3 Up      Nic
      4 Up      Diagnostics
-----
Done.
....
Ready...
nsa
Sending the application software around the network
Application size is 953950 bytes (uncompressed)
Down load complete length 450 offset 953500
Ignore - receiving own command
file received on nic 0003
file received successfully on node 2 controller 1
file received on nic 0001

Active Mode - Press Scroll Lock to go to scroll back mode. Speed = 38400 bps Tx Rx Not Logging
Start Logging Modem Connect No call in progress
  
```

When you enter the NSA command the “Sending Application” dialogue will appear and the offset will increase in value until it reaches the Application Size. At this point the “Down Load Complete” message will appear as well as file received confirmations for each controller and NIC on the network. It is important that you receive one of these messages from each controller (except the one that you are programming from) and NIC on the system before proceeding to the next step.

Program the panels around the network using the **NPA** (Network Program Application) command:

NPA

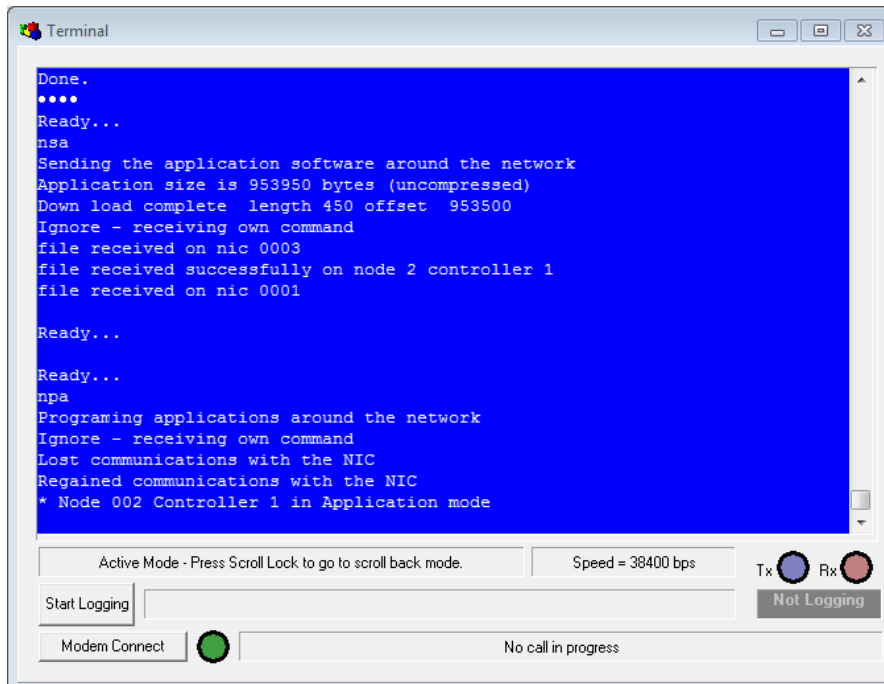

```

Terminal
Done.
....
Ready...
nsa
Sending the application software around the network
Application size is 953950 bytes (uncompressed)
Down load complete length 450 offset 953500
Ignore - receiving own command
file received on nic 0003
file received successfully on node 2 controller 1
file received on nic 0001

Ready...

Ready...
npa
Programing applications around the network
Ignore - receiving own command
Lost communications with the NIC
Regained communications with the NIC
* Node 002 Controller 1 in Application mode

Active Mode - Press Scroll Lock to go to scroll back mode. Speed = 38400 bps Tx Rx Not Logging
Start Logging Modem Connect No call in progress
  
```

A short time after entering the NPA command all of the remote Controllers and NIC’s on the network (except the one that you are programming from) will program and re-start.

As the rest of the panels on the network are in application mode you should now boot the local panel using the **GA** (Go Application) command:

GA

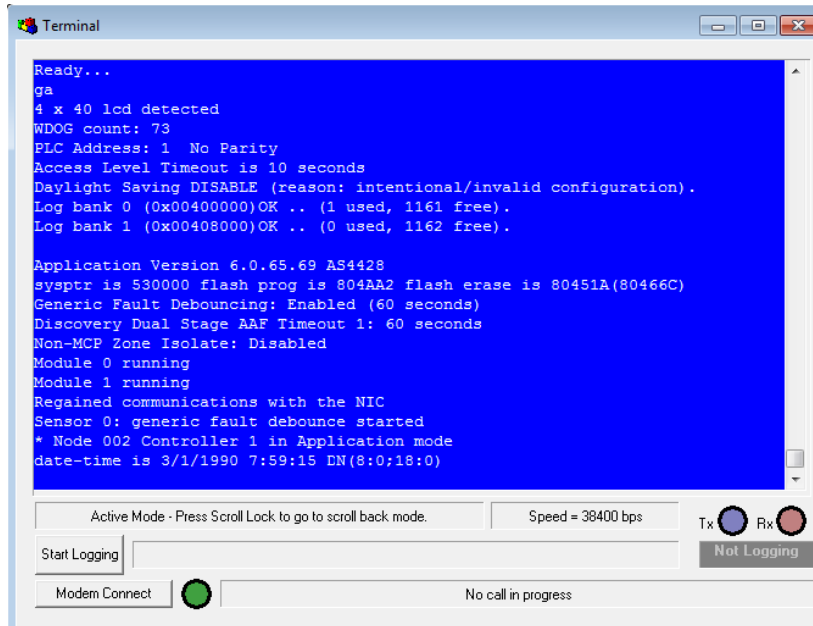

Once the system power up is complete use the **QP** command to verify that all nodes and controllers are operational:

QP

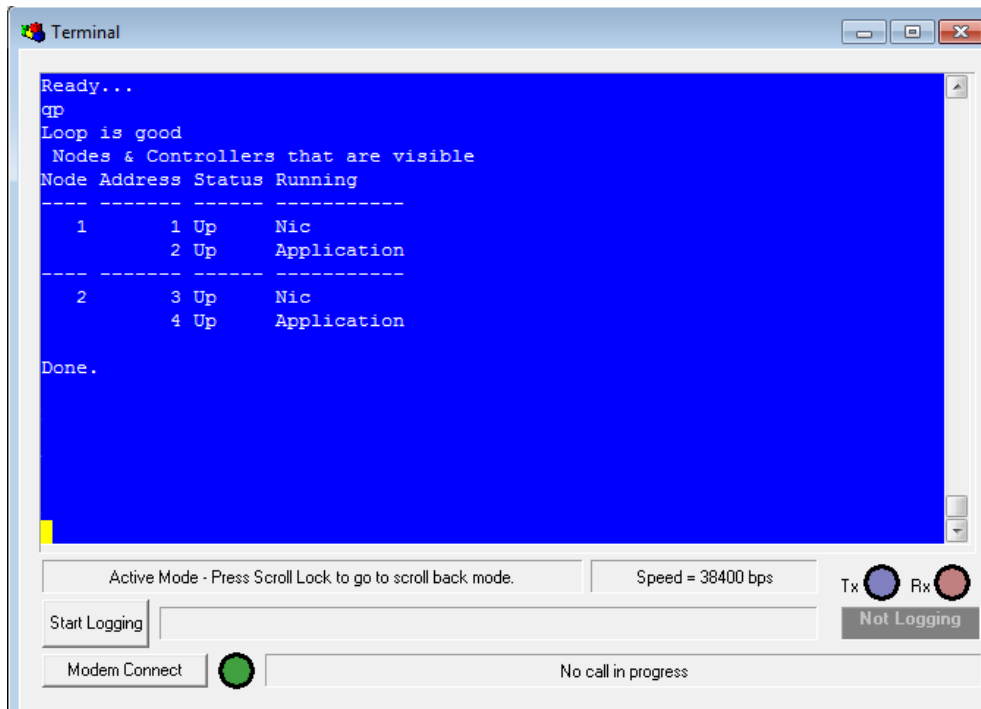

13 Help Commands

The following lists of commands are dependent upon the software version of the panel as not all of the commands are supported prior to Version 6.

In the normal running mode of the panel there are several help commands that are available if required. By typing "he" and pressing enter, the following list of commands will appear.

13.1 Application Mode Help Commands (he)

bf n deactivate the brigade outputs
 bi n isolate the brigade outputs
 bo n activate the brigade outputs
 Where n=3(bell), n=4(plant), n=5(evac), n=6(fault), n=7(alarm), n=8(isol), n=9(batt), n=10(valve monitor)
 bm buzzer mute
 bt go boot
 gd go diagnostics
 qv query version
 wb warm boot

13.2 Advanced Application Mode Help Commands (hea)

bu 0	disable fault buzzer	ef 0	disable earth fault
bu 1	enable fault buzzer	ef 1	enable earth fault
da	node address and cont no.	fi	flash identify
db 0	disable all debug	li	log information
db 1	enable sensors updates	qc	query configuration
db 2	enable module updates	qp	query points
db 3	enable loop updates	sa	dbase offsets for the modules
db 4	enable received network packets	sb	show status of the mailboxes
db 5	enable network sent packets	sl	status of loop
db 6	enable nic packets	sm	status of module
dc	display config table	sp	status of the panel
dd	display ddcmp statistics	ss	status of sensor
dl	display application limits	vr	read charger voltage
dm	display memory	vs	set charger voltage
du	display utility table	wb	warm boot
ed	display eeprom		

13.3 Network Commands available (hen)

nbn	network buzzer mute	nga	network go application
nbu 0	network disable fault buzzer	npc	network program configuration
nbu 1	network enable fault buzzer	npa	network program application
nef 0	network disable earth fault	nsc	network send configuration
nef 1	network enable earth fault	nsa	network send application
ngd	network go diagnostics	nwb	network warm boot

13.4 Boot Mode (he) (hea) (hen)

Commands available

da	read address switch	pa	program application
dm	display memory	qv	query version
ed	display eeprom	fi	flash id
ee	erase eeprom	fe	flash erase
ep	program eeprom	bs	boot stop
ei	erase eeprom	cn	connect to nic
gd	go diagnostics		

13.5 Diagnostic Mode (hea)

Advanced Commands available

bu 0	disable fault buzzer	bu 1	enable fault buzzer
ci	init config table	da	node address and cont no.
dav	display analogue values	db 0	disable all debug
db 1	enable sensors updates	db 2	enable module updates
db 3	enable loop updates	db 4	enable received network packets
db 5	enable network sent packets	db 6	enable nic packets
dc	display config table	dd	display ddcmp statistics
dl	display application limits	dm	display memory
du	display utility table	ed	display eeprom
ee	erase eeprom single location	ef 0	disable earth fault
ef 1	enable earth fault	el	erase the logs
ep	program eeprom	ei	erase eeprom
fi	flash identify	li	log information
ldx	log download (x = a, f or i)	pi	init password block
qp	query points	ui	init utility block
vr	read charger voltage	vs	set charger voltage
wb	warm boot	end	

13.6 Diagnostic Mode (he)

Commands available

Bt	go boot
Ga	go application
Pc	program configuration
Qv	query version
Sz	upload configuration
Wb	warm boot

14 Troubleshooting

Symptom	Possible Cause	Remedy
The Laptop Displays Atv0e0s0=2	This is caused by the wrong cable being use between the FireFinder Series II and the laptop. Use a straight dte cable (rd,td,gnd)	Use correct cable
An error is reported when using the PC or PA commands	The file has an error or there has been an error in transmitting the file	Reload the file. If the problem persists there may be a problem with the connection between the panel and the PC or the files may be corrupt. (In this case contact AMPAC)
Panel fails to power up	A bad file has been loaded or a transmission error has occurred.	Reload software into panel

15 Decimal – Hexadecimal – Binary Conversion Table

Decimal	Hex	Binary	Decimal	Hex	Binary	Decimal	Hex	Binary
0	0	00000000	51	33	00110011	101	65	01100101
1	1	00000001	52	34	00110100	102	66	01100110
2	2	00000010	53	35	00110101	103	67	01100111
3	3	00000011	54	36	00110110	104	68	01101000
4	4	00000100	55	37	00110111	105	69	01101001
5	5	00000101	56	38	00111000	106	6a	01101010
6	6	00000110	57	39	00111001	107	6b	01101011
7	7	00000111	58	3a	00111010	108	6c	01101100
8	8	00001000	59	3b	00111011	109	6d	01101101
9	9	00001001	60	3c	00111100	110	6e	01101110
10	a	00001010	61	3d	00111101	111	6f	01101111
11	b	00001011	62	3e	00111110	112	70	01110000
12	c	00001100	63	3f	00111111	113	71	01110001
13	d	00001101	64	40	01000000	114	72	01110010
14	e	00001110	65	41	01000001	115	73	01110011
15	f	00001111	66	42	01000010	116	74	01110100
16	10	00010000	67	43	01000011	117	75	01110101
17	11	00010001	68	44	01000100	118	76	01110110
18	12	00010010	69	45	01000101	119	77	01110111
19	13	00010011	70	46	01000110	120	78	01111000
20	14	00010100	71	47	01000111	121	79	01111001
21	15	00010101	72	48	01001000	122	7a	01111010
22	16	00010110	73	49	01001001	123	7b	01111011
23	17	00010111	74	4a	01001010	124	7c	01111100
24	18	00011000	75	4b	01001011	125	7d	01111101
25	19	00011001	76	4c	01001100	126	7e	01111110
26	1a	00011010	77	4d	01001101	127	7f	01111111
27	1b	00011011	78	4e	01001110	128	80	10000000
28	1c	00011100	79	4f	01001111	129	81	10000001
29	1d	00011101	80	50	01010000	130	82	10000010
30	1e	00011110	81	51	01010001	131	83	10000011
31	1f	00011111	82	52	01010010	132	84	10000100
32	20	00100000	83	53	01010011	133	85	10000101
33	21	00100001	84	54	01010100	134	86	10000110
34	22	00100010	85	55	01010101	135	87	10000111
35	23	00100011	86	56	01010110	136	88	10001000
36	24	00100100	87	57	01010111	137	89	10001001
37	25	00100101	88	58	01011000	138	8a	10001010
38	26	00100110	89	59	01011001	139	8b	10001011
39	27	00100111	90	5a	01011010	140	8c	10001100
40	28	00101000	91	5b	01011011	141	8d	10001101
41	29	00101001	92	5c	01011100	142	8e	10001110
42	2a	00101010	93	5d	01011101	143	8f	10001111
43	2b	00101011	94	5e	01011110	144	90	10010000
44	2c	00101100	95	5f	01011111	145	91	10010001
45	2d	00101101	96	60	01100000	146	92	10010010
46	2e	00101110	97	61	01100001	147	93	10010011
47	2f	00101111	98	62	01100010	148	94	10010100
48	30	00110000	99	63	01100011	149	95	10010101
49	31	00110001	100	64	01100100	150	96	10010110
50	32	00110010						

Decimal	Hex	Binary	Decimal	Hex	Binary	Decimal	Hex	Binary
151	97	10010111	201	c9	11001001	251	fb	11111011
152	98	10011000	202	ca	11001010	252	fc	11111100
153	99	10011001	203	cb	11001011	253	fd	11111101
154	9a	10011010	204	cc	11001100	254	fe	11111110
155	9b	10011011	205	cd	11001101	255	ff	11111111
156	9c	10011100	206	ce	11001110			
157	9d	10011101	207	cf	11001111			
158	9e	10011110	208	d0	11010000			
159	9f	10011111	209	d1	11010001			
160	a0	10100000	210	d2	11010010			
161	a1	10100001	211	d3	11010011			
162	a2	10100010	212	d4	11010100			
163	a3	10100011	213	d5	11010101			
164	a4	10100100	214	d6	11010110			
165	a5	10100101	215	d7	11010111			
166	a6	10100110	216	d8	11011000			
167	a7	10100111	217	d9	11011001			
168	a8	10101000	218	da	11011010			
169	a9	10101001	219	db	11011011			
170	aa	10101010	220	dc	11011100			
171	ab	10101011	221	dd	11011101			
172	ac	10101100	222	de	11011110			
173	ad	10101101	223	df	11011111			
174	ae	10101110	224	e0	11100000			
175	af	10101111	225	e1	11100001			
176	b0	10110000	226	e2	11100010			
177	b1	10110001	227	e3	11100011			
178	b2	10110010	228	e4	11100100			
179	b3	10110011	229	e5	11100101			
180	b4	10110100	230	e6	11100110			
181	b5	10110101	231	e7	11100111			
182	b6	10110110	232	e8	11101000			
183	b7	10110111	233	e9	11101001			
184	b8	10111000	234	ea	11101010			
185	b9	10111001	235	eb	11101011			
186	ba	10111010	236	ec	11101100			
187	bb	10111011	237	ed	11101101			
188	bc	10111100	238	ee	11101110			
189	bd	10111101	239	ef	11101111			
190	be	10111110	240	f0	11110000			
191	bf	10111111	241	f1	11110001			
192	c0	11000000	242	f2	11110010			
193	c1	11000001	243	f3	11110011			
194	c2	11000010	244	f4	11110100			
195	c3	11000011	245	f5	11110101			
196	c4	11000100	246	f6	11110110			
197	c5	11000101	247	f7	11110111			
198	c6	11000110	248	f8	11111000			
199	c7	11000111	249	f9	11111001			
200	c8	11001000	250	fa	11111010			

16 Certification Information

The *FireFinder Series II*TM is designed and manufactured by:

AMPAC TECHNOLOGIES PTY LTD

7 Ledger Rd

Balcatta

WA 6021

Western Australia

PH: 61-8-9201 6100

FAX: 61-8-9201 6101



(HEAD OFFICE)

Manufactured to: _____

Certificate of Compliance Number: _____

Equipment Serial Number: _____

Date of Manufacture: _____

17 Definitions

Addressable system: a fire alarm and detection system that contains addressable alarm zone facilities or addressable control devices.

Alarm Verification Facility (AVF): that part of the FACP, which provides an automatic resetting function for spurious alarm signals so that they will not inadvertently initiate Master Alarm Facility (MAF), or ACF functions. Using ConfigManager prior to downloading to the *FireFinder Series II* sets this option

Alarm zone: the specific portion of a building or complex identified by a particular alarm zone facility.

Alarm Zone Circuit (AZC): the link or path that carries signals from an actuating device(s) to an alarm zone facility(s).

Alarm Zone Facility (AZF): that part of the control and indicating equipment that registers and indicates signals (alarm and fault) received from its alarm zone circuit. It also transmits appropriate signals to other control and indicating facilities.

Alert signal: an audible signal, or combination of audible and visible signals, from the occupant warning system to alert wardens and other nominated personnel as necessary to commence prescribed actions.

Ancillary Control Facility (ACF): that portion of the control and indicating equipment that on receipt of a signal initiates predetermined actions in external ancillary devices.

Ancillary equipment: remote equipment connected to FACP.

Ancillary relay: relay within FACP to operate ancillary equipment.

Ancillary output: output for driving ancillary equipment.

Approved and approval: approved by, or the approval of, the Regulatory Authority concerned.

Card-detect link: a link on a module connector to indicate the disconnection of the module.

Conventional System: is a fire detection system using a dedicated circuit for each alarm zone.

Distributed system: a fire alarm and detection system where sections of the control and indicating equipment are remotely located from the FACP or where sub-indicator panel(s) communicate with a main FACP.

Field connections: are connections made to FACP or ancillary equipment during installation.

Fire alarm system: an arrangement of components and apparatus for giving an audible, visible, or other perceptible alarm of fire, and which may also initiate other action.

Fire detection system: an arrangement of detectors and control and indicating equipment employed for automatically detecting fire and initiating other action as arranged.

Fire Alarm Control Panel (FACP): a panel on which is mounted an indicator or indicators together with associated equipment for the fire alarm or sprinkler system.

Fire resisting: an element of construction, component or structure which, by requirement of the Regulatory Authority, has a specified fire resistance.

Indicating equipment: the part of a fire detection and or alarm system, which provides indication of any warning signals (alarm and fault), received by the control equipment.

Interface: The interconnection between equipment that permits the transfer of data.

Main equipment: equipment essential to the operation of the system including, control equipment, amplification equipment and power supply modules.

Master Alarm Facility (MAF): that part of the equipment which receives alarm and fault signals from any alarm zone facility and initiates the common signal (alarm and/or fault) for transmission to the fire control station. Bells and other ancillary functions may be initiated from this facility.

Regulatory Authority: an authority administering Acts of Parliament or Regulations under such Acts.

Self-Resetting: A detector configuration such that the alarm is reset when the alarm condition has been removed after a period of time defined by the time-out parameter.

UNCONTROLLED DOCUMENT

NOTE: Due to AMPAC's commitment to continuous improvement specifications may change without notice.