



Fire detection and evacuation solutions that save lives.

XPÄNDER



Hub and Cluster

Programming Manual

MAN3090-2

Contents

1	Introduction.....	3
2	System Overview.....	3
3	System Design.....	4
4	Compatibility with Ampac Fire Control Panels.....	4
5	Handling Precautions	4
6	Packaging.....	5
7	Equipment Identification.....	6
8	Equipment Familiarisation.....	7
9	Quick System Programming.....	9
9.1	Panel & Hub Installation	9
9.2	RCC Installation & Programming	9
9.3	Assigning RCCs.....	10
9.4	Device Installation & Programming.....	10
9.5	Assigning Devices	10
10	Equipment Features	11
10.1	Radio Hub.....	11
10.2	RCC	13
10.3	Wireless Devices.....	15
11	Menu Structure.....	16
11.1	Front Display	17
11.2	Menu Navigation.....	17
12	Menu Explanation.....	18
12.1	Device Status.....	18
12.2	Add New Device	23
12.3	Assign Device.....	23
12.4	Remove Device.....	23
12.5	Hub/RCC Options.....	24
12.6	Radio Channels.....	29
12.7	Auto Select	32
12.8	Advanced	32
13	Analogue Values / Fault Rectification.....	36
14	Signal Level Requirements.....	37
15	How to Improve Signal Levels.....	39

1 Introduction

This manual provides a comprehensive guide to the programming of the Ampac Xpander Hub & Cluster System

The Xpander System comprises of a Radio Hub capable of receiving information from a maximum of 31 Radio Cluster Communicators (RCCs). The RCCs are each capable of receiving information from up to 31 wireless devices. The wireless devices include Smoke and Heat detectors, along with manual call points, sounders, sounder beacons, input/output units, combined sounder/detectors and combined sounder strobe/detectors.

The communication between devices to RCC and RCCs to Radio Hub is bidirectional and utilises the 915 MHz frequency. The maximum amount of Radio Hops between RCCs and the Radio Hub is four. This is shown in the following system overview.

The Radio Hub supports four loops of detectors using the XP95 protocol. The Radio Hub communicates to a Loopsense, FireFinder or FireFinder Plus Fire Alarm Control panel, via its loop wiring connection.

An LCD display is provided on the Radio Hub along with function buttons, to allow programming and diagnostics to be carried out for all associated devices and RCCs.

The RCC is a wireless device requiring only a mains power connection. The unit transmits data from up to 31 wireless devices to the Radio Hub, which in turn passes this information to the Fire Alarm Control Panel.

2 System Overview

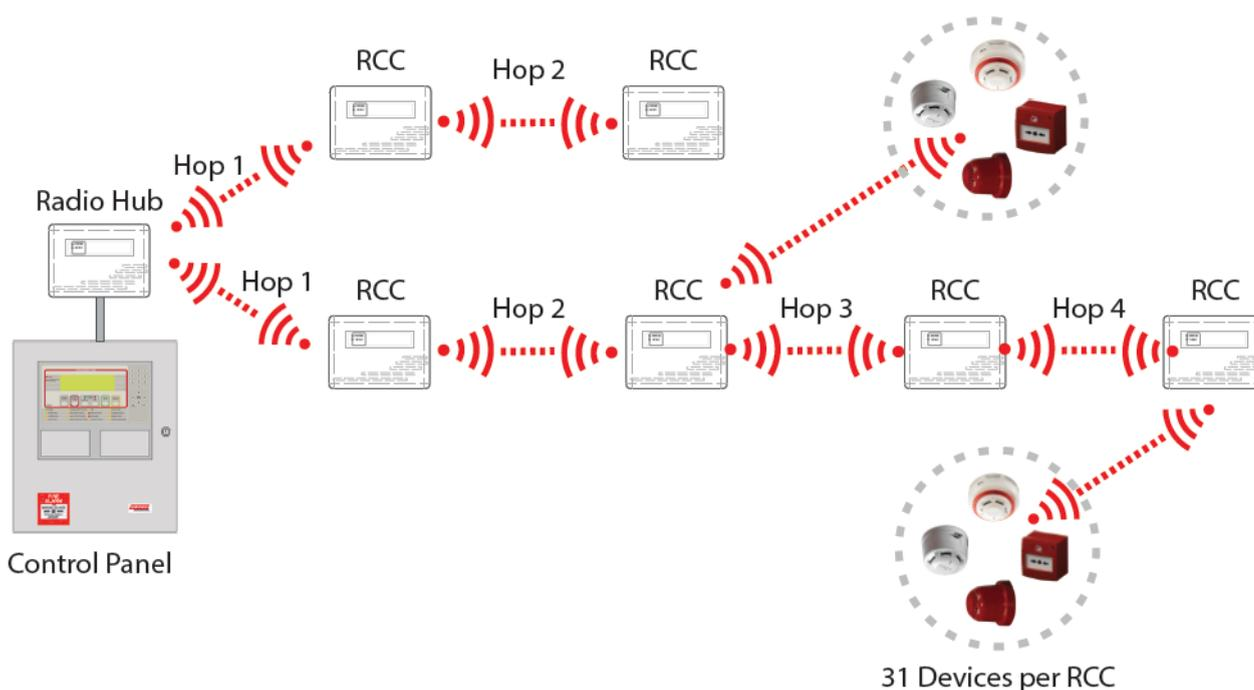

3 System Design

All installation work should be carried out in accordance with the survey and system design.

It is recommended that the Xpander Radio Hub, Radio Cluster Communicators and wireless devices are located in accordance with the radio survey and system design. This should be established before installation work commences.

4 Compatibility with Ampac Fire Control Panels

LoopSense and FireFinder PLUS (AS7240)

Full support for Xpander has been implemented in the LoopSense and FireFinder PLUS fire control panels. Devices can be auto-learned in the same way as XP95 & Discovery devices, and will adopt a default type code which can be re-assigned using the respective panel configuration tool to match the actual device type. For example, the Optical device will log-on as an XP95 Optical which can then be re-defined as an Xpander Optical before transferring the file back to the control panel.

LoopSense & FireFinder PLUS panels provide full Xpander diagnostic indication for fault conditions such as battery fault, tamper fault, signal strength poor along with the standard type faults such as head missing, head dirty and detector fault.

FireFinder (AS4428)

Compatibility with FireFinder is also provided, however discrimination of individual device fault types is not supported and a general, common device fault will be indicated on the LCD. Xpander device types are also not supported within FireFinder and cannot be configured in Config Manager. The devices will adopt the default auto-learned type settings, i.e. XP95 optical, heat etc.

5 Handling Precautions

General: Care should be taken when handling the Ampac product range. Avoid dropping any of the parts onto hard surfaces, as damage may occur to the case and internal circuitry.

ESD Precautions: Ampac Xpander products include components that are susceptible to damage from Electrostatic discharge (ESD). Permanent damage may be caused to these components through routine handling, if precautions are not observed. To reduce the risk of damage from ESD, the following precautions should be observed.

Minimise the handling of PCBs, which contain static sensitive components. Where handling is unavoidable, always ensure that adequate earthing precautions have been taken. An earthed wrist strap is recommended.

When storing or transporting a “loose” PCB, always use a container which has been designed and manufactured with ESD protective properties. Avoid placing static sensitive devices on any surfaces, which may increase the risk of a static discharge.

6 Packaging

All products should be kept in their packaging until they are due to be installed, to minimise the risk of damage. Retain all packaging until the installation activities have been completed. Should any product be found to be surplus to requirements, or require returning to Ampac, the original packaging should be used.

7 Equipment Identification

It is important to establish which devices have been supplied for the installation. Examples of each device are shown below:



Radio Hub
4110-2004



Radio Cluster
Communicator (RCC)
4110-2005



Wireless Input /
Output Unit
4110-2002



Wireless Optical Smoke
Detector
4106-5303



Wireless High Temp CS
Heat Detector
4106-5302



Wireless Rate of Rise A1R
Heat Detector
4106-5301



Wireless Sounder / Sounder
Beacon and Detector
4107-8305



Wireless Call Point
4105-5001



Wireless Sounder
4107-8301



Wireless Sounder /
Sounder Beacon
4107-8301

8 Equipment Familiarisation

Wireless Call Point



Wireless Detector

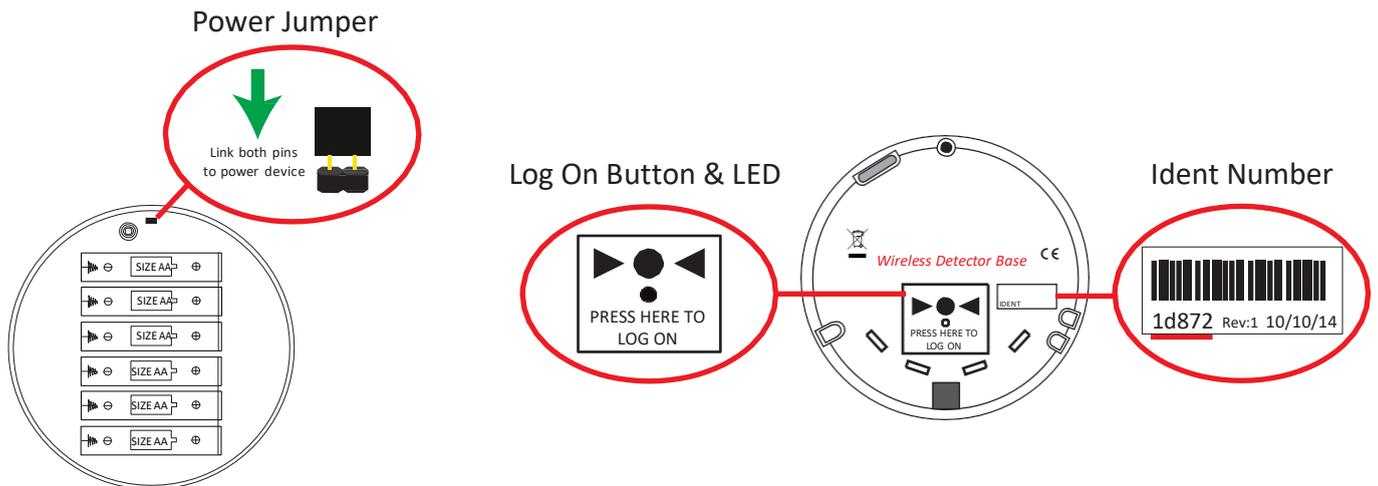

Wireless Sounder & Detector

4 Way DIL Switch
(Switch 1 ON = POWER ON)

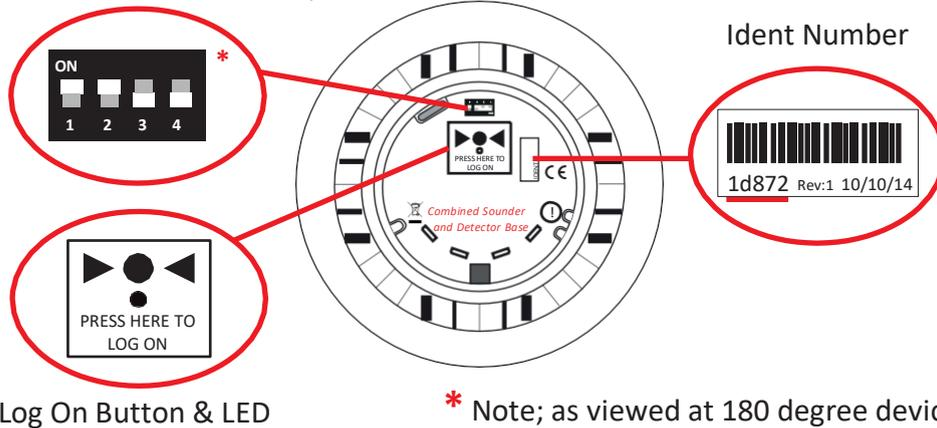

* Note; as viewed at 180 degree device rotation.

Wireless Sounder

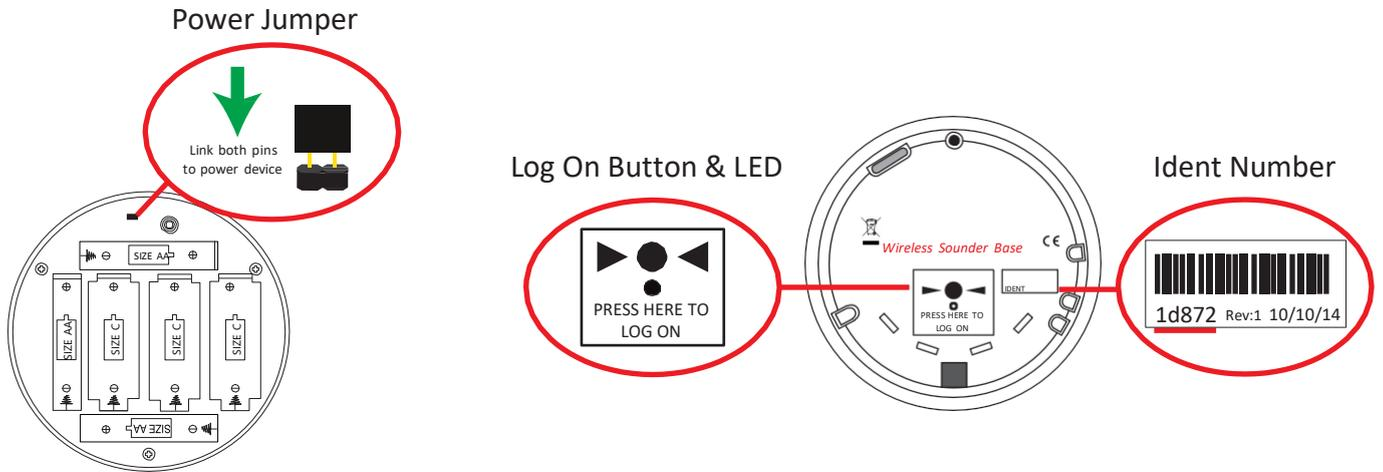

Wireless Input / Output Unit

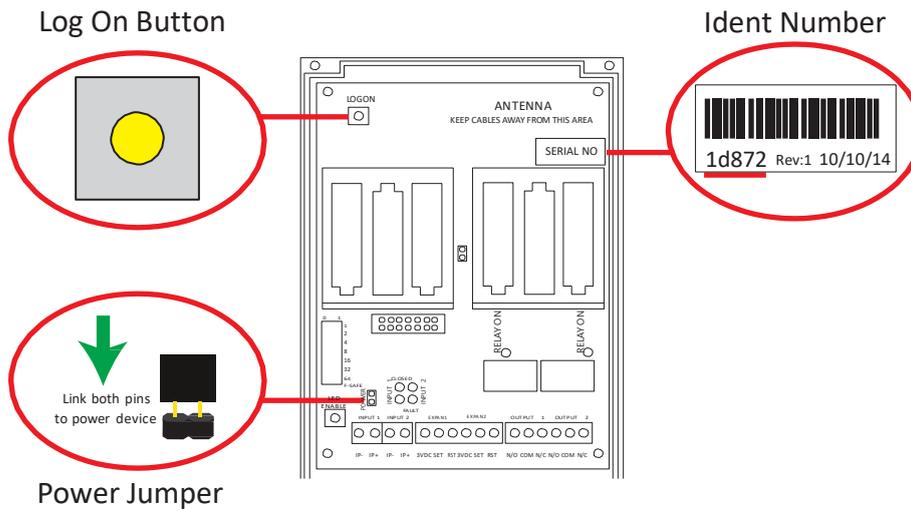

Radio Cluster Communicator

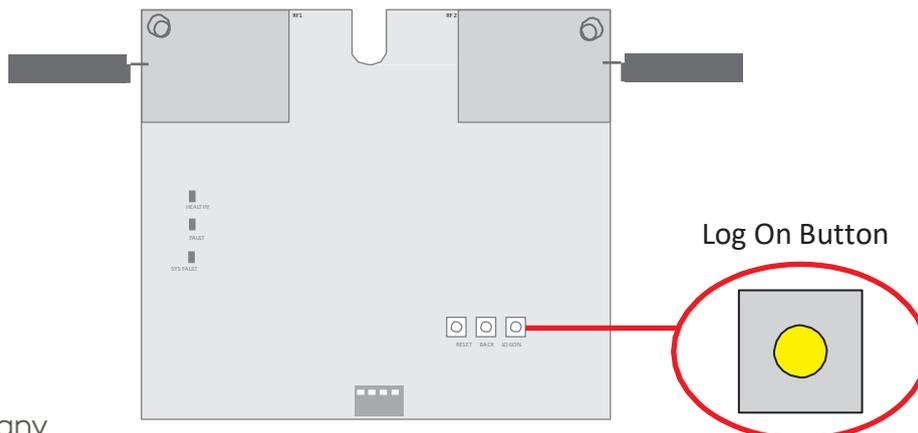

9 Quick System Programming

This quick system programming guide provides a recommended procedure into the installation and programming of the Xpander Radio System.

Before commencing with the installation, the survey report should be available detailing where the control panel and wireless infrastructure is to be fitted.

Ensure the correct equipment is to be fitted at the designated location, see Equipment Familiarisation section.

Ensure the Loop and Address numbers which are to be allocated to the devices and wireless control equipment are known, as they are required when programming. The Radio Hub defaults to Loop 1 Address 1. If this is to be changed, then see the 'Set Hub Address' within the Menu Explanation section.

When using the quick guide the following symbols are shown for the internal controls on the Radio Hub. All programming is undertaken for the system at the Radio Hub.



= Turn & Press Rotary Button to select relevant menu option.



= Press the Back Button to exit the menu.

9.1 Panel & Hub Installation

The Control Panel and the Radio Hub must be installed in their designated locations.

Installation instructions are supplied with each unit and should be followed.

9.2 RCC Installation & Programming

The RCCs should be installed in designated locations.

Installation instructions are supplied with each unit and should be followed.

A unique ident number is shown on the side of each RCC, this should be recorded as it is required when adding the RCC to the Radio Hub.

From Front Display  **Hub/RCC Options**  **Add RCC**  **Select Desired Signal Path *** 

Select Desired Loop & Device Address  **Add By Ident**  **Add Dev 12345 Y?** 'Enter the RCCs ident' 

New Addr L1 A002.



To Exit

** = If the RCC's signal path is to be direct to the Radio Hub then Radio Hub should be selected. If the RCCs signal path is via another RCC, then the relevant RCC will need to be selected. Each option can be chosen by turning the rotary switch.*

9.3 Assigning RCCs

The newly added RCCs should now be assigned.

From Unassigned Dev  **Assign Device**  **Assign RCCs**  **Dev 000 of 001**
changing to **Done 001 of 001** (once complete).



To Exit

9.4 Device Installation & Programming

Wireless devices can be programmed to their relevant RCC prior to their installation. The devices must be powered up and then added to their relevant RCCs, by pressing their log on buttons. For more information about these devices see the Device Power, Logon & Ident Orientations section.

From Front Display  **Add New Device** *Select Desired RCC 01*  **Set Loop 1**  **Addr 003** 
Add By Log On  **Press Dev Log On** *'press the devices log on button, followed by Add Dev 03456 Y?'*
 **New Addr L1 A003.**



To Exit

The device has now been added to the Radio Hub and should be installed in its location, prior to the next step of assigning the device to its relevant RCC. See the relevant devices installation instructions, for more information.

9.5 Assigning Devices

The newly added devices must now be assigned. This can be achieved by selecting;

From Unassigned Dev  **Assign Device**  **Assign All**  **Dev 000 of 003** changing to
Done 003 of 003 (once complete)



To Exit

10 Equipment Features

The Controls and Indications section details the various features of the Radio Hub, Radio Cluster Communicator and wireless devices.

10.1 Radio Hub

The Radio Hub has 3 visible LED indicators from the front of the housing and also internal LED indicators, controls, display and connectors. This section explains their functionality.

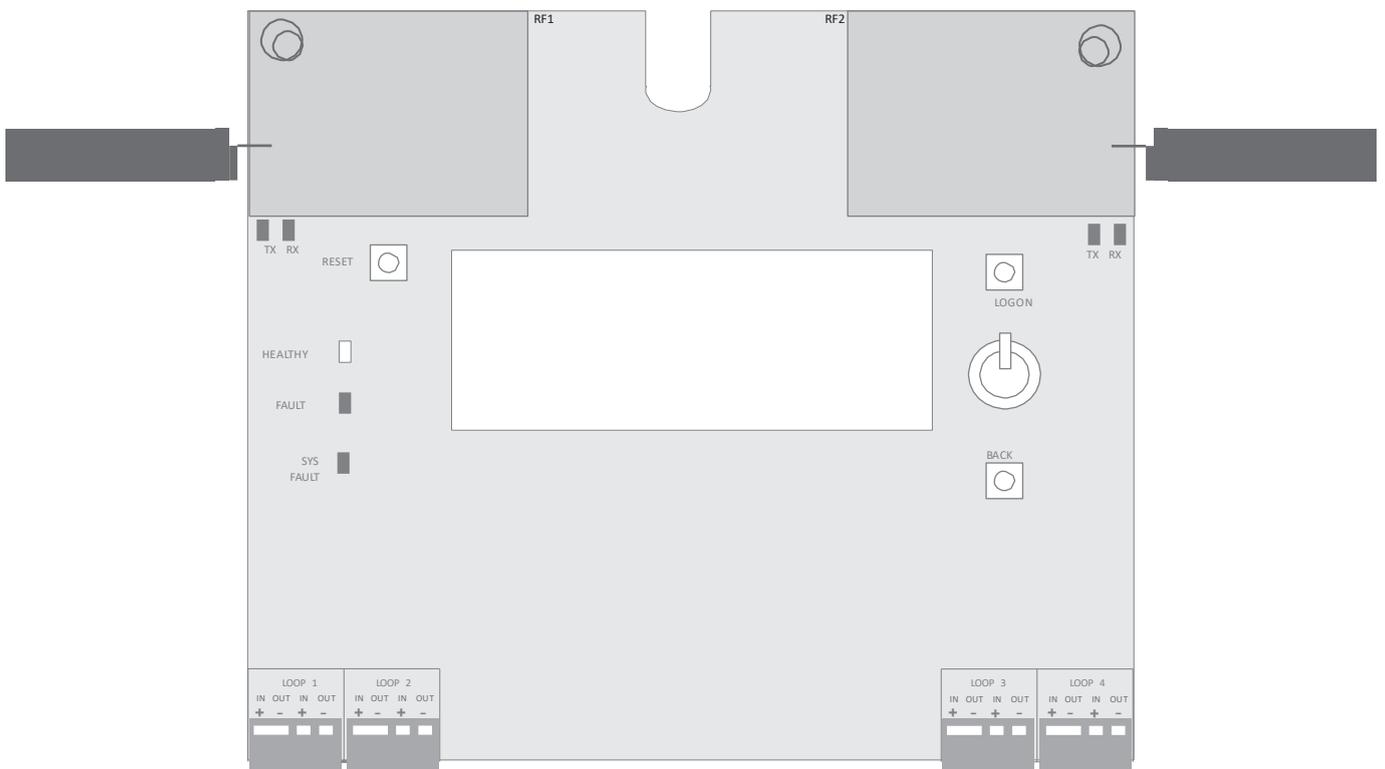

External Indications

Power LED; a green LED will be visible on the front plate of the Radio Hub. This will be illuminated constantly whilst power is supplied to the Radio Hub from the control panel, via the Loop 1 connection.

Fault LED; a yellow LED will be visible on the front plate of the Radio Hub. This will illuminate constantly in the event of an aerial tamper fault on the Radio Hub.

System Fault LED; a yellow LED will illuminate constantly if a checksum error is detected, in either the software program or configuration data.

Internal Indications

RF1 RX LED; a green LED will flash when data is received from a Radio Cluster Communicator, using receiver 1.

RF2 RX LED; a green LED will flash when data is received from a Radio Cluster Communicator, using receiver 2.

RF1 TX LED; a yellow LED will flash when data is transmitted to a Radio Cluster Communicator, using receiver 1.

RF2 TX LED; a yellow LED will flash when data is transmitted to a Radio Cluster Communicator, using receiver 2.

LP 1 LED; a yellow LED will illuminate constantly whilst there is an active, healthy connection on loop 1. The LED will also flash when data is being passed on the loop.

LP 2 LED; a yellow LED will illuminate constantly whilst there is an active, healthy connection on loop 2. The LED will also flash when data is being passed on the loop.

LP 3 LED; a yellow LED will illuminate constantly whilst there is an active, healthy connection on loop 3. The LED will also flash when data is being passed on the loop.

LP 4 LED; a yellow LED will illuminate constantly whilst there is an active, healthy connection on loop 4. The LED will also flash when data is being passed on the loop.

LCD Display; the Radio Hub incorporates a 16 character LCD display, used for displaying the number of devices on the system, along with current alarm and fault totals. This is also used for programming functions.

Rotary Control; a Rotary Control is used to scroll through and enter menu options for programming purposes.

Reset Button; the reset button is used to reset the Radio Hub.

Back Button; the back button is used to move back a step in the menu.

Log On Button; the log on button is not used on the Radio Hub and is for future use.

ENG 1 Port; the engineers port is used to establish connection to a computer based terminal program. This is used for programming purposes, using the Configuration Tool.

Loop 1 -4 Connections; these are used for Loop IN and OUT connections to the fire alarm control panel. The loop connections are used for passing device data to the control panel. Note; Loop 1 connections are used to apply power to the Radio Hub.

10.2 RCC

The Radio Cluster Communicator (RCC) has 2 visible LED indicators from the front of the housing and also internal LED indicators, controls, display and connectors. This section explains their functionality.

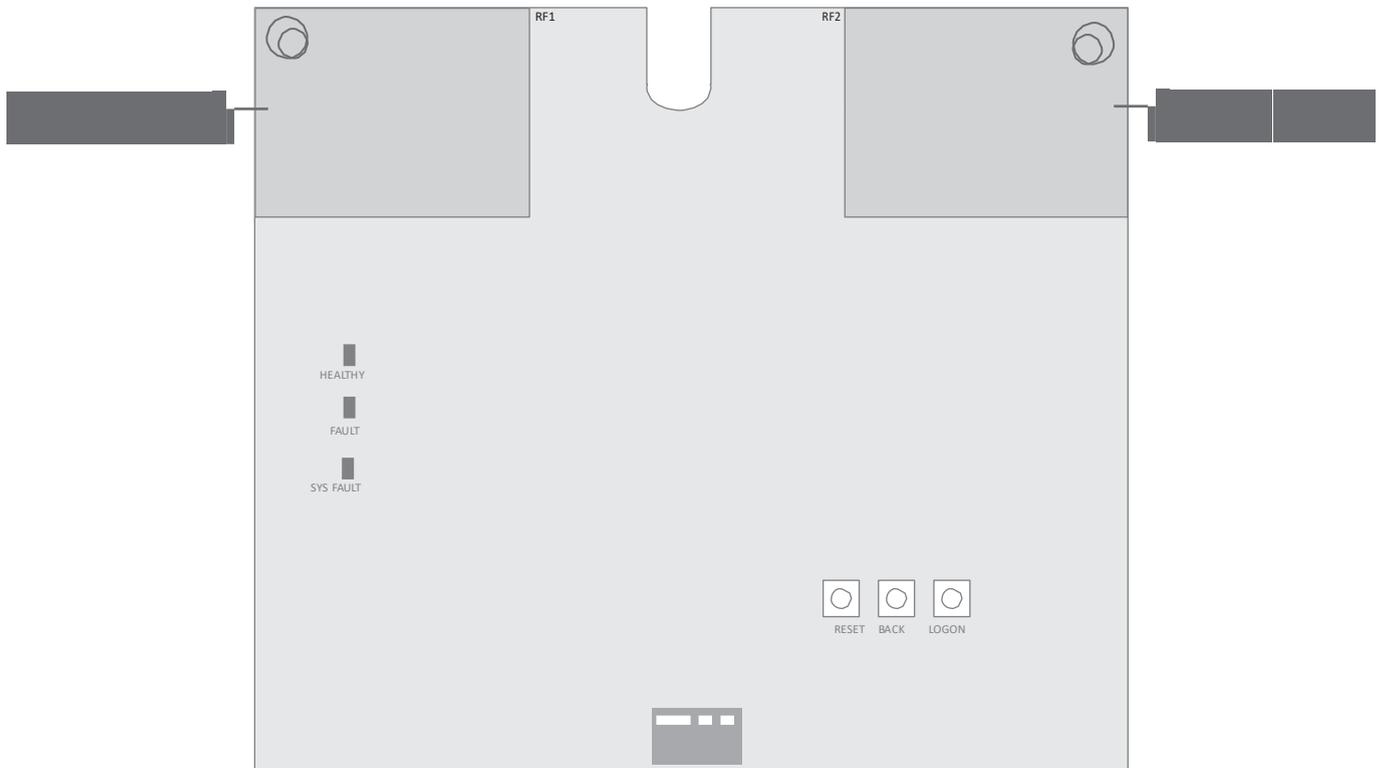

Reset Button; the reset button is used to reset the Radio Cluster Communicator.

Back Button; the back button is not used on the Radio Cluster Communicator.

Log On Button; the log on button is used to log the Radio Cluster Communicator on to the Radio Hub.

ENG 1 Port; the port is used to establish connection to a computer based terminal program. This is used for programming purposes using a Configuration Tool.

Battery/Mains Connections

The RCC will be fitted with one of the following power supply units; both units are identical in operation.

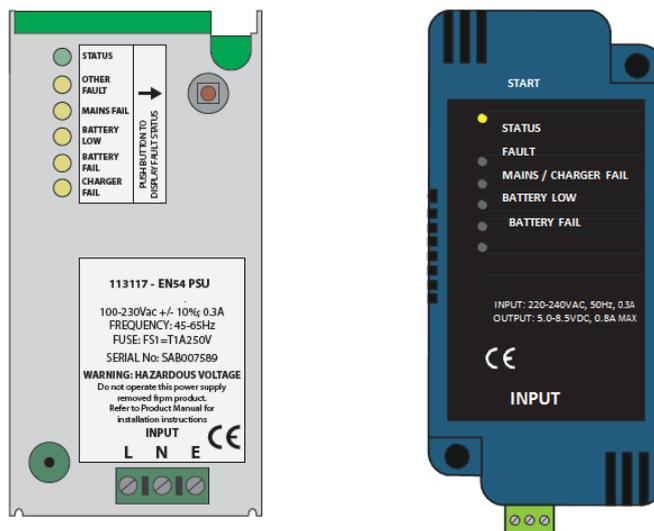

Power Supply PCB

Start Button; the button can be pressed (for one second), to start up the PSU, whilst Mains is not present. The PSU will now operate in power save mode. The relevant Status LEDs will only illuminate whilst the Start button is pressed. Note; this should only be used in emergency conditions and mains should be connected as soon as possible.

Status LED; this LED will be illuminated whilst the PSU is powered. Under mains supply, it will be lit continuously. Whilst in power save mode (battery only) it will flash.

Fault LED; this LED will illuminate whilst any fault is present at the PSU.

Mains / Charger Fail LED; this LED will illuminate whilst the PSU cannot detect a valid mains supply OR when the battery is not charging.

Battery Low LED; this LED will illuminate when the battery voltage is below 5.7V.

Battery Fail LED; this LED will illuminate when the battery is disconnected.

Input L N E; mains connections.

10.3 Wireless Devices

The wireless devices have LED indicators and log on buttons which perform certain functions. This section explains their functionality.

Log On Button; the Log On button is used for adding devices to the system. The required procedure for achieving this is detailed within the 'Quick System Programming' section of this manual. The action of pressing the log on button for 2 seconds will revert the device to its commissioning frequency channels to allow addition to the system, and also illuminate the log on LED.

NOTE: Care should be taken not to press this button when the unit is already added to the system and operating on its allocated frequencies as this frequency information will be lost and default to the devices commissioning channels.

Log On LED; the LED is allocated next to the Log On button on the detector and sounder. This will illuminate when the log on button has been pressed for two seconds. On a call point the Alarm LED on the front of the device is utilised as indication that the Log On button has been pressed for 2 seconds.

Alarm LED; the Alarm LED will switch on in the event of an alarm condition detected by the device. The device controls this indication for the first 10 seconds of the alarm condition. After the initial 10 seconds the LED indication is completely controlled by the connected Fire Alarm Control panel and will therefore turn on and off as instructed to do so by the programming in the panel.

Audio Detect Enable Switch; an audio detect switch is located on the sounder base. This feature can be enabled for each of the sounder output stages 1 or 2 using the corresponding number on the 2 way switch. When enabled the unit carries out tests when operated, by checking the actual sound output. If no sound is detected within 10 seconds of the sounder base being switched on a fault will be indicated at the control panel. This feature should be disabled for a beacon only unit (Switch 1 and 2 off).

Output LED; an Input/output device has a red LED associated with each relay output. If the LED enable button is pressed and the output is activated the LED will illuminate. The LED's will be illuminated for 10 minutes and then automatically time out.

Input Fault; an Input/output device has a yellow fault LED associated with each input. If the LED enable button is pressed and the input is in a fault condition the LED will be illuminated. The LEDs will be illuminated for 10 minutes and then automatically time out.

Input Switch Closed; an Input/Output device has a red switch closed LED associated with each input. If the LED enable button is pressed and the input is closed the LED will be illuminated. The LEDs will be illuminated for 10 minutes and then automatically time out.

11 Menu Structure

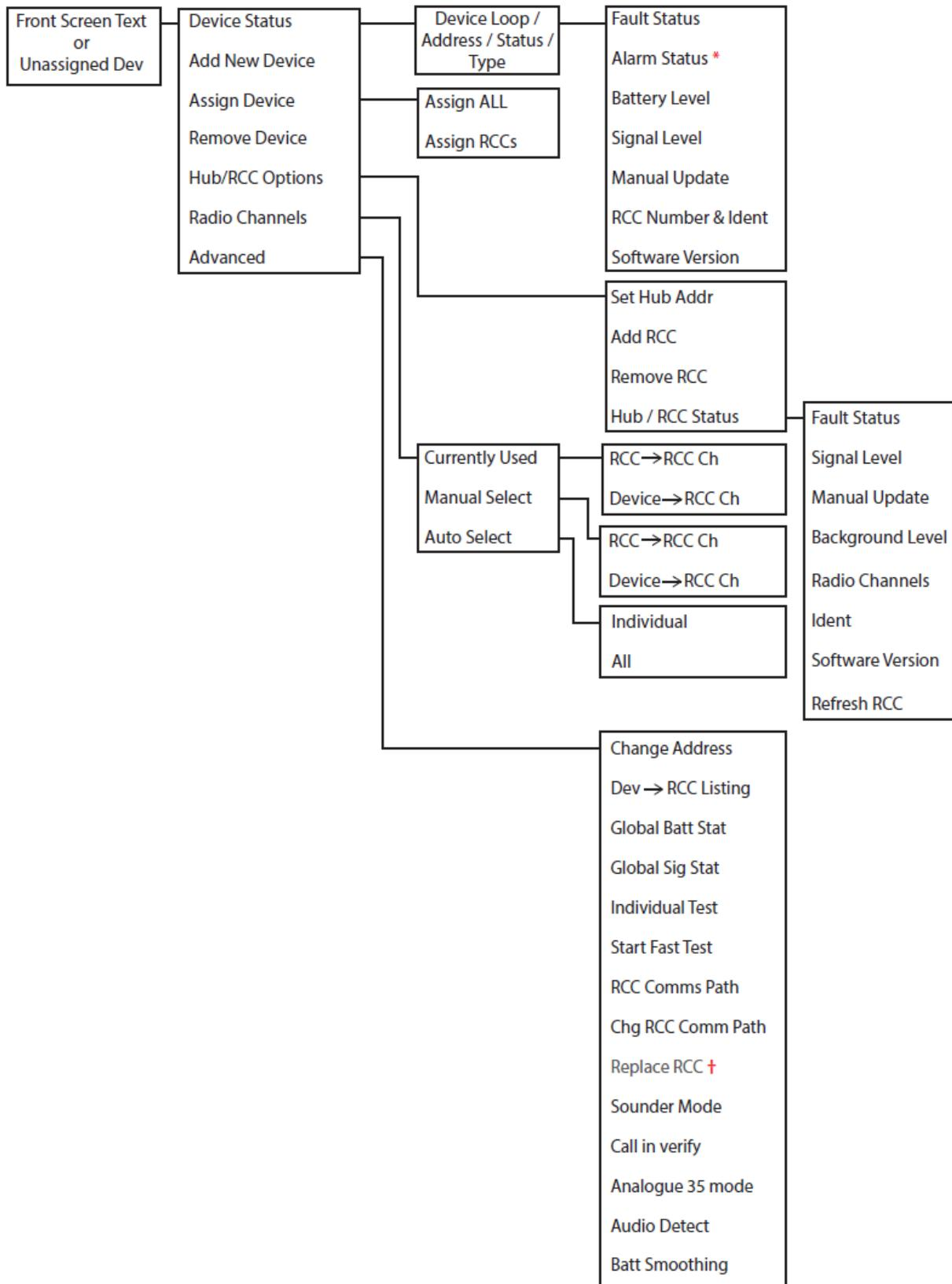

* Alarm Status shown as I/O Status for Input/Output device types.

† Programming features not yet released in this version of software.

11.1 Front Display

Once the Control Panel and the Radio Hub are installed and powered up, the Radio Hub will show the following default screen:



TOT001 A000 F000

Where:

TOT001 = The Total number of devices logged to the Hub (including the Radio Hub itself) across all 4 possible loop options.

A000 = The total number of alarm conditions on the system across all 4 possible loops.

F000 = The total number of faults currently on the system across all 4 possible loops.

Note: As default, the Radio Hub will be set as device address 001 on loop 1. This can be changed if required within the 'Set Hub Address' menu option.

Note: If there are any unassigned devices, the screen will change to show;



Un-assigned Dev

11.2 Menu Navigation

Entry to the menu and into the required menu options can be achieved by pressing the rotary control. The menu options can be browsed by turning the rotary control to scroll through the menu. Exiting from a menu option is achieved automatically after 30 seconds or by pressing the back button located on the Radio Hub.

To access the Users menu's from the front display screen, follow the steps listed below:



TOT186 A000 F000

Press the rotary control. The display will change to show;



Device Status

The menus can be easily navigated by rotating the rotary control until the desired option is highlighted and pressing the rotary control to enter the selected option. See the 'MENU LAYOUT' section for navigation assistance.

The menu structure section details each of the menu options, highlighting their effect within the Xpander system. A quick step by step guide is shown at the end of each of the menu descriptions to aid navigation.



= Turn and Press Rotary Button to select relevant option:

12 Menu Explanation

12.1 Device Status

The device status menu lists all of the devices assigned to all the loops. Devices can be scrolled through using the rotary controller. The allocated loop and address numbers are shown, along with the device type and its current status. The devices are displayed in Loop and Address number order.

Front  Display Device Status

A typical display is shown below;



L1 A003 L Optic

The descriptions for the shown display are as follows;

L1; In this example this indicates that the device is assigned to loop 1.

A003; In this example this indicates that the device is assigned to address 003.

L; This field indicates the devices current status*.

Optic; This field indicates the device type†.

*** Available current device statuses are:**

L; Logged On to the RCC and in normal condition.

U; Device is unassigned to an RCC.

C; Combined sounder / detector logged on to the RCC and in normal condition. Note: such device shall hold two loop addresses. (The first for its sounder and the next for its detector).

!; Fault present. (See fault status descriptions).

; Fire present.

; Pre alarm present.

† Available device type fields are:

Optic; Optical Detector

Sound; Sounder Device

I/O; Input/Output Device

Heat; Heat Detector

MCP; Manual Callpoint

Fault Status; Upon entry, this shows the devices fault condition information. To view the actual fault for a particular device, the rotary control can be pushed to display a fault description. If a device has multiple faults, they can be individually viewed by turning the rotary control.

Front Display  **Device Status**  *Select Desired Device No*  **Fault Status***

* The available fault descriptions are described below;

No Device Faults; this description indicates that the device is not in any fault condition and is operating correctly.

In Tamper; this indicates that the devices tamper switch is not currently making contact, against the ceiling or wall mounted base plate.

Head Missing; this indicates that the detectors head, sounder, strobe only or sounder/strobe head is not currently fitted on the wireless base.

Signal Fault; this is indicated for two reasons. Firstly it indicates that there has currently not been any communication, between the device and its associated Radio Cluster Communicator (RCC) for 300 seconds. Secondly, if the signalling path is poor and communication is being achieved albeit at an unacceptable level for reliable communication.

Battery Fault; this shows that the device has either a low battery and has a minimum operational life of 7- 30 days, or has a battery missing.

Head Dirty; this shows that the detectors head is deemed as dirty/contaminated.

No Sndr Audio; the primary and secondary stage sounder tones can be monitored. If enabled and no audio is detected within 10 seconds upon sounder activation, the *No Sndr Audio* fault is indicated. See the device installation instructions for full configuration details.

Note: Ensure audio monitoring is disabled on beacon only devices to confirm correct operation.

Head Fault; this indicates that a detectors head has a fault i.e. no communication between the head and the wireless base.

Short Circuit; this indicates a short circuit wiring fault on the input of an I/O unit.

Open Circuit; this indicates an open circuit wiring fault on the input of an I/O unit.

Unassigned; this description indicates that the device is unassigned to the system. Assigning the device is possible by pressing the rotary control to assign or visiting the Assign Devices option from the main menu.

Alarm Status; when entered, this shows the devices alarm condition information. To view the actual alarm for a particular device, the rotary control can be pushed to select the device and this will then display the alarm description.

Front Display  **Device Status**  *Select Desired Device No*  **Alarm Status***

* The available alarm descriptions are described below;

In Fire; this indicates the device is currently in a fire alarm condition.

In Pre Alarm; this indicates the device is currently in a Pre alarm condition.

I/O Status; this shows the current Input and Output information on Input/Output devices. To view the status of the inputs and outputs for a particular device, the rotary control can be pushed to select the device and this will then display the status information description.

Front Display  **Device Status**  *Select Desired Device No*  **IN: x-x OUT: x-x***

* The available descriptions are shown below;

IN: 0-0; this indicates that input 1 and 2 is in the open (normal) state.

IN: 1-0; this indicates that input 1 is in the closed (activated) state.

IN: 0-1; this indicates that input 2 is in the closed (activated) state.

IN: 1-1; this indicates that input 1 and 2 is in the closed (activated) state.

OUT: 0-0; this indicates that output 1 and 2 is in the open (normal) state.

OUT: 1-0; this indicates that output 1 is in the closed (activated) state.

OUT: 0-1; this indicates that output 2 is in the closed (activated) state.

OUT: 1-1; this indicates that output 1 and 2 is in the closed (activated) state.

Battery Level; this menu when entered shows information on the selected device's battery status. The status of the pack is updated whenever there is a status change or automatically updated every 6 hours. This is broken down into five sections.

Front Display  Device Status  Select Desired Device No  Battery Level*

* Each device will show the status of its two battery packs. The battery status information is displayed as follows;

Pack 1 OK; this indicates a good battery voltage is present in Pack 1. This is represented by displaying a full battery icon.

Pack 1 Warning; this indicates the battery voltage is low in Pack 1 and is a 30 day warning indication. The batteries must be changed on the device within 30 days for continued reliable operation. This is represented by displaying a half full battery icon.

Pack 1 Low; this indicates the battery voltage is low in Pack 1 and is a 7 day warning indication. The batteries must be changed on the device within 7 days, for continued reliable operation. This is represented by displaying an empty battery icon.

Pack 1 Missing; this indicates a battery from Pack 1 is missing. The battery must be inserted on the device for continued reliable operation. This is represented by displaying an **X** symbol.

Pack 2 OK; this indicates a good battery voltage is present in Pack 2. This is represented by displaying a full battery icon.

Pack 2 Warning; this indicates the battery voltage is low in Pack 2 and is a 30 day warning indication. The batteries must be changed on the device within 30 days, for continued reliable operation. This is represented by displaying a half full battery icon.

Pack 2 Low; this indicates the battery voltage is low in Pack 2 and is a 7 day warning indication. The batteries must be changed on the device within 7 days for continued reliable operation. This is represented by displaying an empty battery icon.

Pack 2 Missing; this indicates a battery from Pack 2 is missing. The battery must be inserted on the device for continued reliable operation. This is represented by displaying an **X** symbol.

Signal Level; this menu allows the signal levels for devices to be viewed. When entered detailed signaling information is displayed on the two signaling channels used by the device in both directions, as the devices are bi-directional. The received signal strength at the devices associated RCC is shown as a D → RCC01 level, therefore indicating the signal that has been sent from the device to the RCC (the 01 represents the RCC number). The D → RCC01 level is updated on every poll response (123 seconds). The forward signal strength received at a device from the RCC is shown as a D → RCC01 level, therefore indicating the signal that has been sent from the RCC to the device. The D → RCC01 level is updated automatically every 6 hours or immediately when requested by selecting the Manual Update Option from the menu. Turning the rotary control will change the display between the 2 channels. Pressing the rotary control switch will revert between the D → RCC01 level display and D ← RCC01 signal levels for each channel. Signal strengths are shown in dB. The levels displayed are already calculated taking into account the background level away from the received signal strength, therefore no further calculations are required.

Front Display  Device Status  Select Desired Device No  Signal Level

Ch1 D → RCC02; this indicates the received signal strength at the devices associated RCC (in this example RCC number 02) from the device on the first frequency channel used by the system. A level from 0 - 45 is shown to indicate the levels, a table of which is shown at the end of this section.

Ch2 D → RCC02; this indicates the received signal strength at the devices associated RCC (in this example RCC number 02) from the device on the second frequency channel used by the system. A level from 0 - 45 is shown to indicate the levels, a table of which is shown at the end of this section.

Ch1 D ← RCC02; this indicates the forward signal strength received at the device from the associated RCC (in this example RCC number 02) on the first frequency channel used by the system. A level from 0 - 45 is shown to indicate the levels, a table of which is shown at the end of this section.

Ch2 D ← RCC02; this indicates the forward signal strength received at the device from the associated RCC (in this example RCC number 02) on the second frequency channel used by the system. A level from 0 - 45 is shown to indicate the levels, a table of which is shown at the end of this section.

20dB or greater	Indicates a good signal level
13 to 19dB	Indicates a medium signal level
8 to 12dB	Indicates a low signal level
1 to 7dB	Indicates a caution signal level
0dB	Indicates no signal level is being received

Manual Update; this menu allows individual devices to update the system with their current signal levels. To send a signal request, press the rotary control button with the device shown on the display. The menu will change to show that it's updating the signal level. Once completed, check the new signal level by entering the Signal Level menu.

Front Display  Device Status  Select Desired Device No  Manual Update followed by Update Requested

RCC Number & Ident; this displays the RCC number that the selected device is currently assigned to along with the devices ident. You can also change the RCC that the device is logged onto by pressing the Rotary Control when the RCC number is displayed and then selecting a new RCC from the available list.

Front Display  **Device Status**  *Select Desired Device No*  **RCCxx**
IDxxxxx

Software Version; this displays the devices software version.

Front Display  **Device Status**  *Select Desired Device No*  **Software**
Vxx.xx

12.2 Add New Device

This menu allows all wireless device types to be added to the system. The function allows the device to be added using either the log on button situated on the device or by programming the devices unique identification number into the Radio Hub via the Rotary Controls. The Loop address number associated for the device along with the devices allocated Radio Cluster Communicator is also allocated at this stage of adding the device to the system. A guide to adding devices is shown in the 'Quick Step by Step Guide To System Programming' section of this manual.

Front Display  **Add New Device**

12.3 Assign Device

This menu assigns any unassigned wireless devices to their associated Radio Cluster Communicators. This must be performed once a device has been added to the system and the device has been installed in its correct location.

Front Display  **Assign Device**

12.4 Remove Device

This section allows wireless devices to be removed from the system. A list of devices already allocated to the system are shown, these can be scrolled through by turning the rotary control. When the device required to be removed is shown on the display the rotary control can be pushed to select this device. This will show the devices unique identification number, if correct, selecting 'Yes' will remove the device from the system.

Front Display  **Remove Device**

12.5 Hub/RCC Options

This menu allows access to the configuration of the Radio Hub and Radio Cluster Communicators.

Front Display  **Hub/RCC Options**

Set Hub Address; this section allows the Radio Hub to be allocated to a particular loop and Loop Address number. As default the Radio Hub will be set as device address 001 on loop 1.

Front Display  **Hub/RCC Options**  **Set Hub Address**

Add RCC; this section allows a Radio Cluster Communicator (RCC) to be added to the system. The function allows the unit to be added using either the log on button situated on the unit or via the devices unique identification number. The associated Loop number i.e. 1-4, Loop address number for the RCC and its signal path are all programmed within this menu.

Front Display  **Hub/RCC Options**  **Add RCC**

Remove RCC; this section allows an RCC to be removed from the system. A list of RCCs already allocated to the system are shown, these can be scrolled through by turning the rotary control. When the RCC requiring removal is shown on the display, the rotary control can be pushed to select this device. Once the rotary control has been rotated to display 'Remove Device Yes', pressing the rotary control will remove the RCC from the system.

NOTE: RCCs can only be removed from the system when no devices are allocated to that particular RCC.

Front Display  **Hub/RCC Options**  **Remove RCC**

Hub/RCC Status; when entered, this menu lists the Radio Hub and all of the Radio Cluster Communicators added to the system. These can be scrolled through using the rotary controller. The allocated loop and address numbers are shown along with their current status.

Front Display  **Hub/RCC Options**  **Hub/RCC Status**

A typical display is shown below;



L1 A003 L RCC01

The descriptions for the shown display are as follows;

L1; this example indicates that the device is assigned to loop 1.

A003; this example indicates that the device is assigned to address 003.

L; this field indicates the devices current status*.

RCC; this field indicates the device type†.

* Available options are:

L; logged On to the Radio Hub and in normal condition.

U; RCC is unassigned to the Radio Hub.

!; a fault is present. (See fault status descriptions).

† Available options are:

RCC01; Radio Cluster Communicator numbered from 01-31

Hub; Radio Hub

Fault Status; this menu when entered shows information on any Radio Hub or Radio Cluster Communicator that are currently in a fault condition. To view the actual fault for a particular unit, the rotary control can be rotated and pushed to select the relevant address and this will then display a fault description. If multiple faults are outstanding, then by turning the rotary control they can be individually viewed.

Front Display  Hub/RCC Options  RCC/Hub Status  Select Desired Device No 

Fault Status*

*The available fault descriptions are described below;

No Device Faults; this description indicates that there are not any faults present on the Radio Hub or RCCs.

Mains Fault; this description indicates that there is no mains present on the RCC.

No Signal/PSU; this description indicates that there has been no communication between the Radio Hub and Radio Cluster Communicator (RCC) for 300 seconds, or that communication is being achieved but not at an acceptable level for reliable communication. This fault may also indicate total loss of power to the Radio Cluster Communicator (RCC).

Battery Fault; this description indicates that there is either no battery present, the battery is low or there is a battery charger fail on an RCC.

Processor Fail; this description indicates that the on board processor on an RCC or Radio Hub is in a failure condition.

Receiver Fail; this description indicates that the one of the onboard wireless receivers on an RCC or Radio Hub is in a failure condition.

Aerial Tamper; this description indicates that a remote aerial on the RCC or Radio Hub is not attached or damaged. Internal aerials are not required to be monitored however all remote aerials have a monitoring resistance of 47KO. If this resistance is not present on any of the remote aerial connections then an aerial tamper fault will be displayed. Note: Remote aerials are not yet supported at present on the Xpander system.

RCC Ch1 RFI Det; this description indicates that a radio frequency interference signal has been detected on radio channel 1 that the RCC network communication path is operating on.

RCC Ch2 RFI Det; this description indicates that a radio frequency interference signal has been detected on radio channel 2 that the RCC network communication path is operating on.

DEV Ch1 RFI Det; this description indicates that a radio frequency interference signal has been detected on radio channel 1 that the radio device to RCC communication path is operating on.

DEV Ch2 RFI Det; this description indicates that a radio frequency interference signal has been detected on radio channel 2 that the radio device to RCC communication path is operating on.

Unassigned; this description indicates that the device is un-assigned to the system. Assigning the device is possible by pressing the rotary control to assign or visiting the previously detailed 'Assign Devices' option from the main menu.

Signal Level; this menu allows the signal levels for selected Radio Cluster Communicator to be viewed. When entered detailed signalling information is displayed on the two signalling channels used by the RCC in both directions, as the devices are bi-directional. The received signal strength at the Hub from the associated RCC is shown as a R01 → Hub level, therefore indicating the signal that has been sent from the RCC to the Hub (the 01 represents the RCC number). The R01 → Hub level is updated on every poll response (30 seconds). The forward signal strength received at an RCC from the Hub is shown as a R01 → Hub level, therefore indicating the signal that has been sent from the Hub to the RCC. This level is also updated on every poll response or immediately when requested by selecting the Manual Update Option from the menu. Turning the rotary control will change the display between the 2 channels. Pressing the rotary control switch will revert between the R01 → Hub level display and R01 → Hub signal levels for each channel. Signal strengths are shown in dB. The levels displayed are already calculated taking into account the background level away from the received signal strength, therefore no further calculations are required.

Front Display  Hub/RCC Options  Hub / RCC Status  Select Desired Device No  Signal Level

Ch1 R01 → Hub 070dB; this indicates the received signal strength at the Radio Hub from the RCC 01 on the first frequency channel used by the system. A level from 0 - 105 is shown to indicate the levels, a table of which is shown at the end of this section.

Ch2 R01 → Hub 070dB; this indicates the received signal strength at the Radio Hub from the RCC 01 on the second frequency channel used by the system. A level from 0 - 105 is shown to indicate the levels, a table of which is shown at the end of this section.

Ch1 R01 → Hub 070dB; this indicates the forward signal strength received at the RCC 01 from the Radio Hub on the first frequency channel used by the system. A level from 0 - 105 is shown to indicate the levels, a table of which is shown at the end of this section.

Ch2 R01 → Hub 070dB; this indicates the forward signal strength received at the RCC 01 from the Radio Hub on the second frequency channel used by the system. A level from 0 - 105 is shown to indicate the levels, a table of which is shown at the end of this section.

20dB or greater	Indicates a good signal level
8 to 19dB	Indicates a low signal level
1 to 7dB	Indicates a caution signal level
0dB	Indicates no signal level is being received

Manual Update; this menu allows individual RCCs to update the system with their current signal levels. To send a signal request, press the rotary control button with the relevant RCC shown on the display. The menu will change to show 'Update Requested'. Once completed, check the new signal level by entering the Signal Level menu.

Front Display  Hub/RCC Options  Hub / RCC Status  Select Desired Device No 

Manual Update

Background Level; when entered, this menu allows the Radio Hub or Radio Cluster Communicators background level to be viewed. The levels are shown for each of the two channels being used by the unit. The second channel can be viewed by turning the rotary control. Background levels are shown in -dB.

Front Display  Hub/RCC Options  Hub / RCC Status  Select Desired Device No 

Background Level

Radio Channels; this menu allows you to view the radio channels currently used by the Radio Hub and Radio Cluster Communicators.

Front Display  Hub/RCC Options  Hub / RCC Status  Select Desired Device No 

Radio Channels

Ident; this menu allows the units unique ident number to be viewed.

Front Display  Hub/RCC Options  Hub / RCC Status  Select Desired Device No  Ident

Software Version; this menu allows the software version to be viewed.

Front Display  Hub/RCC Options  Hub / RCC Status  Select Desired Device No 

Software Version

12.6 Radio Channels

This menu allows you to view or alter the frequency channels currently used by the system.

NOTE: Alterations to the Radio Hub and RCC communication channels can only be undertaken when no RCCs are allocated to the system. Alterations to the RCC and Device communication channels can only be undertaken when no devices are allocated to that particular RCC.

This can be achieved either manually or automatically. Two channels are required to be selected for the Radio Hub to RCC communication path and two separate channels for the Device to each RCC communication path. It is not possible to select the same channels for these communication paths. When selecting the wireless channels, one channel must be from the Low Band range and the other must be from the High Band range. This will ensure a minimum of 100 KHz spacing between channels. The Radio Channels used to communicate between the Radio Hub and the RCCs are factory set. It is however recommended that it is reconfigured to suit the sites environment. This must be performed before any RCCs are added to the system. The Radio Channels used to communicate between the Devices and the RCCs are also factory set. It is however recommended that it is reconfigured to suit the sites environment. This must be performed before any devices are added to the system. An example of channel allocation is shown in the next section.

Front Display  **Radio Channels**

32 channels are available for use on the system and these are as follows:

Low Bands		High Bands	
<i>Low Band 1</i>		<i>High Band 1</i>	
Ch1: 915.952 MHz		Ch17: 916.654 MHz	
Ch5: 916.052 MHz		Ch21: 916.754 MHz	
Ch9: 916.153 MHz		Ch25: 916.854 MHz	
Ch13: 916.253MHz		Ch29: 916.954 MHz	
<i>Low Band 2</i>		<i>High Band 2</i>	
Ch2: 915.977 MHz		Ch18: 916.679 MHz	
Ch6: 916.077 MHz		Ch22: 916.779 MHz	
Ch10: 916.178 MHz		*Ch26: 916.879 MHz	
Ch14: 916.278 MHz		Ch30: 916.979 MHz	
<i>Low Band 3</i>		<i>High Band 3</i>	
Ch3: 916.002 MHz		Ch19: 916.704 MHz	
Ch7: 916.102MHz		Ch23: 916.804 MHz	
Ch11: 916.203MHz		Ch27: 916.904 MHz	
Ch15: 916.303MHz		Ch31: 917.005 MHz	
<i>Low Band 4</i>		<i>High Band 4</i>	
Ch4: 916.027 MHz		Ch20: 916.729 MHz	
*Ch8: 916.128 MHz		Ch24: 916.829 MHz	
Ch12: 916.228 MHz		Ch28: 916.929 MHz	
Ch16: 916.328 MHz		Ch32: 916.030 MHz	

*Default channels on power

Multiple RCC Channel Allocation Example

The example below shows a multiple RCC installation using different frequency channels. The channels used in the example are colour coded and also shown in the table below. Having a system setup in this way ensures the two device channels used for each RCC are taken from the low and from the high band and are not duplicated. The system setup in this way also shows that the Radio Hub to RCC channels are selected from the low and high bands are also not duplicated across the system.

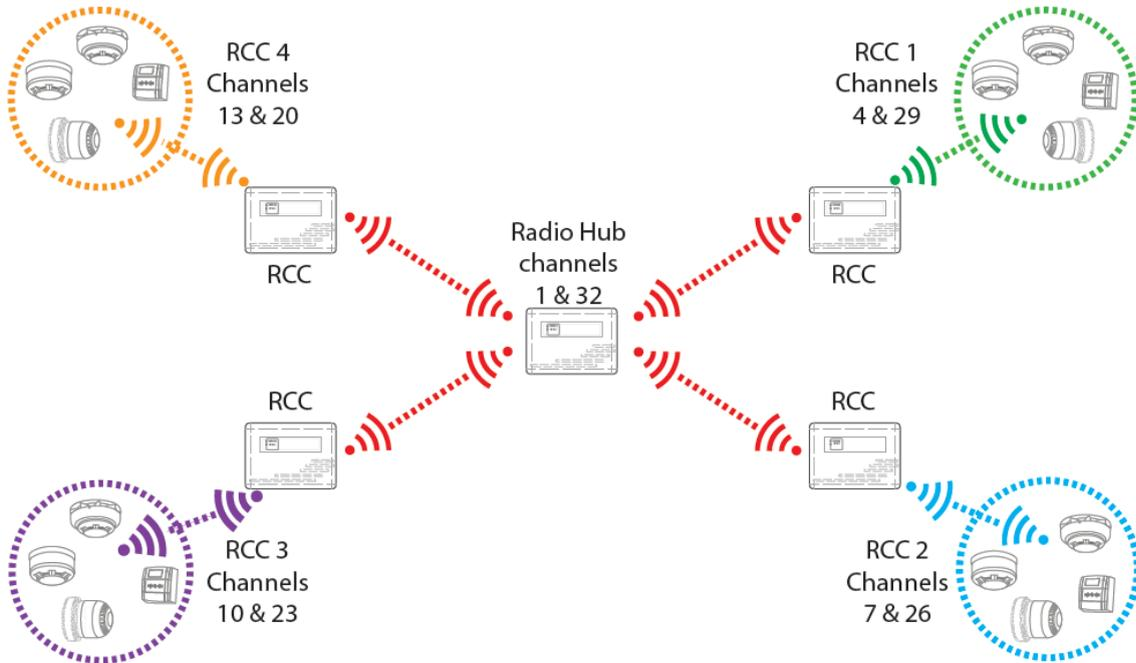

Low Bands		High Bands	
Low Band 1		High Band 1	
Ch1: 915.952 MHz	Radio Hub to all RCCs	Ch17: 916.654 MHz	
Ch5: 916.052 MHz		Ch21: 916.754 MHz	
Ch9: 916.153 MHz		Ch25: 916.854 MHz	
Ch13: 916.253MHz	RCC4 to Devices	Ch29: 916.954 MHz	RCC1 to Devices
Low Band 2		High Band 2	
Ch2: 915.977 MHz		Ch18: 916.679 MHz	
Ch6: 916.077 MHz		Ch22: 916.779 MHz	
Ch10: 916.178 MHz	RCC3 to Devices	*Ch26: 916.879 MHz	RCC2 to Devices
Ch14: 916.278 MHz		Ch30: 916.979 MHz	
Low Band 3		High Band 3	
Ch3: 916.002 MHz		Ch19: 916.704 MHz	
Ch7: 916.102MHz	RCC2 to Devices	Ch23: 916.804 MHz	RCC3 to Devices
Ch11: 916.203MHz		Ch27: 916.904 MHz	
Ch15: 916.303MHz		Ch31: 917.005 MHz	
Low Band 4		High Band 4	
Ch4: 916.027 MHz	RCC1 to Devices	Ch20: 916.729 MHz	RCC4 to Devices
*Ch8: 916.128 MHz		Ch24: 916.829 MHz	
Ch12: 916.228 MHz		Ch28: 916.929 MHz	
Ch16: 916.328 MHz		Ch32: 916.030 MHz	Radio Hub to all RCCs

* Default channels on power up

Currently Used

Once entered, currently used channels for 'RCC → RCC Ch' and 'Device → RCC Ch' will be accessible.

RCC → RCC Ch; channels being used for the RCC to RCC communication can be viewed by selecting the following:

Front Display  Radio Channels  Currently Used  RCC → RCC Ch

Device → RCC Ch; channels being used for the Device to RCC communication can be viewed by selecting the following:

Front Display  Radio Channels  Currently Used  Device → RCC Ch  Select relevant RCC no

Manual Select

Once entered, options for 'RCC → RCC Ch' and 'Device → RCC Ch' manual selection of channels will be available.

RCC → RCC Ch; RCC to RCC communication channels can only be manually changed whilst no RCCs are on the system. Care must be taken to select one channel from the High band and one from the Low band as previously detailed within in the Radio Channels section:

Front Display  Radio Channels  Manual Select  RCC → RCC Ch

For example:

Radio Hub to RCC Communication path Low Band Ch1, High Band Ch32

Device → RCC Ch; device to RCC communication channels can only be manually changed whilst no devices are added to the RCC. Care must be taken to select one channel from the Low band and one from the High band as described in the Radio Channels section:

Front Display  Radio Channels  Manual Select  Device → RCC Ch

For example:

Device to RCC Communication path Low Band Ch 4, High Band Ch 29

12.7 Auto Select

Once entered, options for 'Individual' and 'All' automatic channel selections will be available.

Individual; individual Device to RCC communication channels can only be automatically selected whilst no devices are added to the RCC. This option will allow a scanning time to be selected between 1-60 mins. In this time the frequency channels will be scanned and at the end of the timer, the two best channels for use will be selected:

Front Display  Radio Channels  Auto Select  RCC → RCC Ch

All; all of the RCCs Device to RCC radio channels can automatically selected whilst no devices are added to the system. This option will allow a scanning time to be selected between 1-60 mins. In this time the frequency channels will be scanned and at the end of the timer, the two best channels for each RCC will be selected:

Front Display  Radio Channels  Auto Select  Device → RCC Ch

12.8 Advanced

Within this menu, a selection of advanced options are available.

Front Display  Advanced

Change Address; this menu allows the Loop number and address of a device to be changed if required.

Front Display  Advanced  Change Address

Device →RCC Listing; this menu allows you to view all of the devices assigned to each RCC. Once the desired RCC has been selected, devices can be viewed by scrolling through the list of devices.

Front Display  Advanced  Device →RCC Listing

Global Batt Stat; this menu allows the wireless devices battery statuses to be viewed. The devices are listed in loop and address order.

Each device will show the status of its two battery packs. The battery status information is displayed as follows;

P1 and a full battery icon; this indicates a good battery voltage is present in Pack 1.

P1 and a half full battery icon; this indicates the battery voltage is low in Pack 1 and is a 30 day warning indication.

P1 and an empty battery icon; this indicates the battery voltage is low in Pack 1 and is a 7 day warning indication.

P1 and an X symbol; this indicates a battery from Pack 1 is missing.

P2 and a full battery icon; this indicates a good battery voltage is present in Pack 2.

P2 and a half full battery icon – this indicates the battery voltage is low in Pack 2 and is a 30 day warning indication.

P2 and an empty battery icon; this indicates the battery voltage is low in Pack 2 and is a 7 day warning indication.

P2 and an X symbol; this indicates a battery from Pack 2 is missing.

Front Display  **Advanced**  **Global Batt Stat**

Global Sig Stat; this menu will display the signal level in dB for each device and RCC over a 24 hour period. This is listed in Loop and Address Number order. After the system has been running for a 24 hour period the wireless device and RCC signal levels should display 20dB or above. If any devices are under the signal level requirements, check the flowchart On How to Improve Device Signal Levels section for guidance.

Front Display  **Advanced**  **Global Sig Stat**

Meeting the acceptable signal levels shown ensures the immunity to site attenuation (path loss) is met.

Individual Test; in this menu, output tests can be performed on individual devices. This will allow the LED's to be turned on for detectors and call points, individual sounder operation and relay output operation on Input /Output units.

Front Display  **Advanced**  **Individual test**

Start Fast Test; in this menu, loops can be entered into fast test for ease of testing. This allows the detectors on the selected loops to be triggered into an alarm condition quicker than normal. The led on the device will flash to indicate it is in this fast test mode. A time period of between 1 and 30 minutes is selectable which decrements and is then re-generated on a fire alarm event. The devices automatically come out of fast test mode when the timer expires or the fast test mode is exited.

Front Display  **Advanced**  **Start Fast Test**

RCC Comms Path; this menu allows you to view to path of communication between Radio Cluster Communicator (RCC) to the Radio Hub whether it is direct from the RCC to the Radio Hub or from the RCC to the Radio hub via another RCC. The loop number and address number is shown along with the number of hops the RCC uses to communicate to the Hub. Pressing the rotary control with the required RCC shown will then show the RCC or Hub that particular RCC is communicating to.

Front Display  **Advanced**  **RCC Comms Path**

Chg RCC Comms Path; this menu allows you to change to path of communication between Radio Cluster Communicator (RCC) to the Radio Hub whether it is direct from the RCC to the Radio Hub or from the RCC to the Radio Hub via an RCC.

Front Display  **Advanced**  **Chg RCC Comms Path**

Replace RCC; this menu option is not currently used on this version of software.

Sounder Mode; this menu allows the auto silencing of wireless sounders to be programmed. Available options are Continuous which disables any auto silencing rules and 30 min cut off. The default setting is to 30 min cut off which will turn all wireless sounders off after 30 minutes to conserve battery life. Any subsequent fire alarm activations will re-activate the sounders again.

Front Display  **Advanced**  **Sounder Mode**

Call in verify; this menu allows access via a password to select between EN and Non-EN modes of system operation for fault monitoring of device communication loss. In EN mode a fault due to the loss of communication with a wireless linked component is indicated at the control and indicating equipment within 300 seconds of occurrence of the fault. In Non-EN mode a fault due to the loss of communication with a wireless linked component is indicated at the control and indicating equipment with 900 seconds of occurrence of the fault. The default for each system is to EN mode.

Front Display  **Advanced**  **Call In Verify**

Analogue Value 35 Mode; this menu allows an analogue value 35 message from a detector, which is a head dirty/ compensation fault to be a selectable option for displaying on the system. The reporting of this status does not compromise the performance of the sensor and or the sensitivity. It is not a requirement for detectors to report contamination events hence this selectable mode. The default is to OFF which will not display these status message types.

Front Display  **Advanced**  **Analogue Value 35 Mode**

Audio Detect; this menu allows the No Sndr Audio fault reporting to be selectable between On and Off on the interface and the Control Panel. If On is selected the Analogue value 1 which is the No Sndr Audio fault description will be displayed on the interface and the Control Panel if this fault type occurs on a sounder device. If Off is selected the above fault will not be displayed on the loop module or the Control Panel. The default is set to Off as there are no requirements to display this message type.

Front Display  **Advanced**  **Audio Detect**

Batt Smoothing; this menu allows the Battery Low fault reporting to be selectable so verification of the low battery can be ascertained before the fault Analogue Value 7 Fault type is displayed on the loop module and the Control Panel. Available smoothing options are selectable between OFF = No smoothing and 1-5 days smoothing in one day steps. If this feature is implemented the systems performance is not compromised and the 30 day battery low warning is still achieved. The default is set to OFF so no smoothing is implemented and the fault type is displayed instantly.

Front Display  **Advanced**  **Batt Smooth**

13 Analogue Values / Fault Rectification

Analogue	Device	Symptom	Rectification
0	All	Battery missing	Check battery connections and voltages. Ensure all batteries are changed if required.
0	RCC	Mains fail	Check the RCCs mains supply.
1	Detector	Head fault	Check that the device is correctly assembled. Failing this, it is recommended that the detector is replaced.
1	Sounder	No audio output	Check the devices audio monitoring switches are set correctly. See the devices installation instructions for more information.
1	Radio Hub	Receiver failure	Try resetting the Radio Hub.
2	Detector	Head missing	Check that the device is correctly assembled. The fault will clear upon successful relocation.
3	Sounder	Head missing	Check that the device is correctly assembled. The fault will clear upon successful relocation.
4	All	Tamper	Check that the device is correctly assembled. The fault will clear upon successful relocation.
4	I/O Units	Input short/open circuit	Check the 20k end of line resistor is in place and that connections are secure.
4	Radio Hub	Aerial tamper	Check for the 47k end of line resistor when measuring between the center pin and the outer screen of both aerials cables and that connections are secure.
4	RCC	Aerial tamper	Check for the 47k end of line resistor when measuring between the center pin and the outer screen of both aerials cables and that connections are secure.
5	Radio Hub	Radio interference	Has any electrical equipment recently been installed in close proximity of the Radio Hub. If so it may need to be moved to an acceptable distance. See Radio Hub Installation Instructions for details.
7	All	Batteries low	Replace all batteries with Duracell Procell batteries.
7	RCC	Battery/charger fail	Check the integrity of the RCCs battery and its connection.
13	All	Signal strength caution	Check devices location to ensure no visible cause can be seen. Check devices signal level information in the Global Sig Stat menu. (See the 'How to improve device signal levels' section for more information).
13	RCC	Signal strength caution	Has any electrical equipment recently been installed in close proximity of the Radio Hub. If so it may need to be moved to an acceptable distance. See Radio Hub Installation instructions for details.
13	Radio Hub	Background level caution	Has any electrical equipment recently been installed in close proximity of the Radio Hub. If so it may need to be moved to an acceptable distance. See Radio Hub Installation instructions for details.
14	All	Signal strength low	Check devices location to ensure no visible cause can be seen. Check devices signal level information in the Global Sig Stat menu. (See the 'How to improve device signal levels' section for more information).
14	RCC	Signal strength low	Has any electrical equipment recently been installed in close proximity of the RCC. If so it may need to be moved to an acceptable distance. See RCC Installation for more information.
14	Radio Hub	Background level medium	Has any electrical equipment recently been installed in close proximity of the Radio Hub. If so it may need to be moved to an acceptable distance. See Radio Hub Installation for more information.
16	Call Point, Sounder & I/O	Signal strength good/medium	No action required.
16	RCC	Signal strength good/medium	No action required.
16	Radio Hub	Background level good	No action required.
20	Detector	Signal strength medium	No action required.
25	Detector	Signal strength good	No action required.
35	Detector	Head dirty	<p>It is recommended that the detector is replaced for new. Please Note: Where temporary work involving the generation of dust, smoke, paint spray, and other aerosols is to be carried out in an area protected by smoke detectors, the removable dust covers supplied with the device should be fitted to prevent contamination or false alarms. The devices should also be temporarily disabled at the Control Panel. Care must also be taken to ensure that the dust covers are removed and the devices re-enabled once the environment is clear.</p> <p>Warning: No attempt should be made to open the case for cleaning inside the head.</p>
50	Detector	Pre alarm	<p>Check device is free from smoke. If no smoke can be seen, it is recommended that the detector is replaced for new. Please Note: Where temporary work involving the generation of dust, smoke, paint spray, and other aerosols is to be carried out in an area protected by smoke detectors, the removable dust covers supplied with the device should be fitted to prevent contamination or false alarms. The devices should also be temporarily disabled at the Control Panel. Care must also be taken to ensure that the dust covers are removed and the devices re-enabled once the environment is clear.</p> <p>Warning: No attempt should be made to open the case for cleaning inside the head.</p>
64	Call Point	Alarm	Check the devices glass is intact.
85	Detector	Alarm	Ensure that the environment of the devices location is free of smoke residue and dust.

14 Signal Level Requirements

To ensure the signal levels for each wireless device and each RCC are at an acceptable level the Global Sig Stat menu should be checked. This menu will display the signal levels in dB for each wireless device and RCC over a 24 hour period. This is listed in Loop and Address Number order. After the system has been running for a 24 hour period the signal levels should display 20dB or above. If any devices are under the signal level requirements, check the flowchart On How to Improve Device Signal Levels section for guidance.

Front Display  **Advanced**  **Global Sig Stat**

An example of a display showing the levels for a system which does have the required signal levels is shown below:

Device Type	Loop / Address	Shown On Display	Acceptable Level
Radio Hub	Loop 1 Address 1	N/A	✓
RCC	Loop 1 Address 2	L1 A002 21dB	✓
Optical Detector	Loop 1 Address 3	L1 A003 35dB	✓
Optical Detector	Loop 1 Address 4	L1 A004 45dB	✓
Manual Call Point	Loop 1 Address 5	L1 A005 35dB	✓
Optical Detector	Loop 1 Address 6	L1 A006 38dB	✓
Optical Detector	Loop 1 Address 7	L1 A007 28dB	✓
Manual Call Point	Loop 1 Address 8	L1 A008 32dB	✓
Optical Detector	Loop 1 Address 9	L1 A009 31db	✓
Heat CS Detector	Loop 1 Address 10	L1 A010 45dB	✓
Optical Detector	Loop 1 Address 11	L1 A011 45dB	✓
Multisensor Detector	Loop 1 Address 12	L1 A012 45dB	✓
Optical Detector	Loop 1 Address 13	L1 A013 42dB	✓
Sounder	Loop 1 Address 14	L1 A014 38dB	✓
Sounder	Loop 1 Address 15	L1 A015 45dB	✓
Sounder Beacon	Loop 1 Address 16	L1 A016 22dB	✓

An example of a display showing the levels for a system which does not have the required signal levels is shown below:

Device Type	Loop / Address	Shown On Display	Acceptable Level
Radio Hub	Loop 1 Address 1	N/A	✓
RCC	Loop 1 Address 2	L1 A002 19dB	✗
Optical Detector	Loop 1 Address 3	L1 A003 35dB	✓
Optical Detector	Loop 1 Address 4	L1 A004 45dB	✓
Manual Call Point	Loop 1 Address 5	L1 A005 17dB	✗
Optical Detector	Loop 1 Address 6	L1 A006 19dB	✗
Optical Detector	Loop 1 Address 7	L1 A007 30dB	✓
Manual Call Point	Loop 1 Address 8	L1 A008 32dB	✓
Optical Detector	Loop 1 Address 9	L1 A009 31db	✓
Heat CS Detector	Loop 1 Address 10	L1 A010 18dB	✗
Optical Detector	Loop 1 Address 11	L1 A011 45dB	✓
Optical Detector	Loop 1 Address 12	L1 A012 45dB	✓
Optical Detector	Loop 1 Address 13	L1 A013 42dB	✓
Sounder	Loop 1 Address 14	L1 A014 38dB	✓
Sounder	Loop 1 Address 15	L1 A015 45dB	✓
Sounder Beacon	Loop 1 Address 16	L1 A016 19dB	✗

Meeting the acceptable signal levels shown ensures the immunity to site attenuation (path loss) is met as required by applicable standards.

15 How to Improve Signal Levels

Device signal levels can be improved by following the flowchart below:

