



Fire detection and evacuation solutions that save lives.



EvacU

Emergency Warning Control and Indicating Equipment
(Occupant Warning Systems)

Technical Manual

MAN3072-11

Contents

| | | |
|----------|--|-----------|
| 1 | About This Manual | 4 |
| 1.1 | Introduction | 4 |
| 1.2 | References | 4 |
| 1.3 | Symbols..... | 4 |
| 2 | System Overview..... | 4 |
| 2.1 | AS4428.16:2015 MANDATORY AND OPTIONAL FUNCTIONS..... | 5 |
| 3 | Specifications | 7 |
| 4 | Front Panel Switch and Indicator Module | 8 |
| 4.1 | Connectors..... | 9 |
| 4.2 | DIP Switch | 9 |
| 4.3 | Indicators | 9 |
| 4.4 | Access Levels..... | 11 |
| 4.5 | Controls..... | 11 |
| 4.5.1 | Press to talk..... | 11 |
| 4.5.2 | Silence Buzzer..... | 11 |
| 4.5.3 | Test | 12 |
| 4.5.4 | Messages..... | 13 |
| 4.5.5 | Reset | 13 |
| 4.5.6 | Alert | 13 |
| 4.5.7 | Evac..... | 14 |
| 4.6 | Emergency Microphone (Optional handheld)..... | 14 |
| 5 | Amplifier Board (25W and 50W) | 15 |
| 5.1 | Remote Paging Console Terminals..... | 15 |
| 5.2 | Digital Inputs..... | 16 |
| 5.2.1 | The Primary (Default) settings:..... | 16 |
| 5.2.2 | The Secondary settings: | 16 |
| 5.2.3 | Custom setting (NZ Special): | 17 |
| 5.3 | Relays..... | 17 |
| 5.4 | Strobe Output | 17 |
| 5.5 | Audio Line Output | 18 |
| 5.6 | DIP switch settings | 18 |
| 5.7 | LED indications | 19 |
| 5.8 | Volume Controls..... | 20 |
| 5.9 | System Messages | 20 |
| 5.10 | Custom Messages..... | 20 |
| 5.11 | Tones | 21 |
| 6 | Tone Generator (120W, 250W and 500W)..... | 23 |
| 7 | Zone Indicator Module | 24 |
| 7.1 | Connectors..... | 24 |
| 7.2 | Indicators and Controls..... | 24 |
| 8 | Audio Line Splitter (ALS) | 26 |
| 8.1 | LED indications | 26 |
| 8.2 | Inputs..... | 27 |
| 8.3 | Relay Output | 27 |
| 8.4 | Audio Line Outputs..... | 27 |
| 8.5 | DIP switch settings | 28 |

| | | |
|-----------|--|-----------|
| 9 | 8 Zone Remote Paging Console | 29 |
| 9.1 | Indicator and Controls | 29 |
| 9.2 | RPC Connection | 30 |
| 10 | Standalone Panels | 31 |
| 10.1 | The Cabinet | 31 |
| 10.2 | Mounting the Cabinet..... | 31 |
| 10.3 | Panel General Layouts | 32 |
| 10.4 | Power Supply Specifications | 34 |
| 10.4.1 | 3 Amp PSU | 34 |
| 10.4.2 | 5 Amp PSU | 35 |
| 10.4.3 | 10 Amp PSU | 37 |
| 10.5 | Multiple Housing/Battery Box requirement | 38 |
| 10.6 | Connecting to OEM equipment..... | 38 |
| 10.7 | 5 Amp & 10 Amp PSU Signalling and Diagnostics | 39 |
| 10.7.1 | Fault Outputs | 39 |
| 10.7.2 | LED Indication | 39 |
| 10.7.3 | Fault Diagnostic table – Front panel – User | 39 |
| 10.7.4 | Fault Diagnostic table – Internal - Engineer | 40 |
| 10.8 | 6050-0008 EvacU Standalone Isolation 50W Amplifier | 40 |
| 10.9 | 6050-0008 EvacU Standalone 50W System Drawing | 42 |
| 11 | Fire Panel Interfacing..... | 43 |
| 11.1 | FireFinder 25W and 50W | 43 |
| 11.2 | FireFinder plus 25W and 50W | 44 |
| 11.3 | LoopSense 25W and 50W | 45 |
| 11.4 | ZoneSense Plus 25W..... | 46 |
| 11.5 | Multiple Amplifiers – LoopSense & FireFinder Plus | 47 |
| 11.6 | Multiple Amplifiers – FireFinder..... | 48 |
| 11.7 | 25W and 50W Amplifier with optional Audio Line Splitter | 49 |
| 11.8 | Paging using Evactron 8 Zone RPC with Multiple Amps | 50 |
| 11.9 | Paging using 157-0001 Single Zone Paging MIC with BGM | 51 |
| 11.10 | 50W OWS Interfacing to Evactron LMU4..... | 52 |
| 11.11 | 120W, 250W & 500W Interfacing to Evactron LMU4..... | 53 |
| 11.12 | 120W, 250W and 500W Interfacing | 54 |
| 12 | Configuring the EWCIE using LoopMaster and FireFinder PLUS ConfigManager..... | 55 |
| 12.1 | FireFinder PLUS ConfigManager..... | 55 |
| 12.2 | LoopMaster | 58 |
| 13 | EvacUwiz Programming Tool | 60 |
| 14 | Maintenance | 61 |
| 15 | Trouble Shooting | 62 |
| 16 | Certification Information..... | 63 |

1 About This Manual

1.1 Introduction

This manual contains all the information required to install, program and operate the **AMPAC EvacU** range of Emergency Warning Control and Indicating Equipment (EWCIE), formally referred to as Occupant Warning System.

1.2 References

AS 4428.16:2015 Emergency Warning Control and Indicating Equipment

1.3 Symbols



Important operational information



Note: Configuration considerations



Observe antistatic precautions

2 System Overview

Designed to comply with the requirements of **AS 4428.16:2015 EWCIE Grades 2 and 3** the **EvacU** EWCIE is intended to broadcast information (voice announcements for emergency purposes, alert signals, evacuate signals, visual and tactile warning devices) to provide warning to the occupants within one or more specified areas in an emergency, to effect a rapid and orderly mobilisation of occupants in an indoor or outdoor area.

Whether combined in Ampac's Fire Control Panels (FACP) or as a fully self-contained Standalone System the EWCIE consists of the Amplifier/s, a Front Panel Switch and Indicator Module and optional Zone Indicating Module, Line Monitoring Units and Remote Paging Console (RPC).

When combined in the FACP the EWCIE communicates with the Fire panel range by either RS485 communication (FireFinder Plus, LoopSense) or by hardwired inputs (ZoneSense Plus, FireFinder).

Alternatively, when the EWCIE is in the Standalone Cabinet or installed with Non-Ampac Fire panels the communication is by hardwired inputs only.

The Amplifier, Front control, Zone Indicator, Line Monitor and RPC communicate with each other via a CAN bus.

Up to 8 Amplifiers can be daisy chained via the CAN bus. Each amplifier supports:

- 100VAC speaker circuit (which supports up to 3 branches)
- Strobe output
- 4 digital inputs
- 3 relay outputs
- RPC/BGM interface

The Front Control Switch and Indicator Module is an "ALL CALL" card and will control all amplifiers.

When individual Emergency Zone speech is required the Zone Indicator Module is required and the Amplifiers must be associated to an Emergency Zones from 1-8 using the **EvacUwiz** programming tool.

The Line Monitoring Unit allows a single amplifier 100V line to be split into 4 Paging Zones. Up to to 8 Paging zones can be programmed using the **EvacUwiz** programming tool.



Emergency Zones and Paging Zones are not necessarily the same zone.

2.1 AS4428.16:2015 MANDATORY AND OPTIONAL FUNCTIONS

The following table shows all the mandatory and optional functions included in the **EvacU** EWCIE.

Note: The applications of these grades are specified in AS 1670.1 and AS 1670.4

| Clause number | Title | Grade 2 | Grade 3 |
|---------------|---|----------------|----------------|
| 7.2 | Indication of alarm signals | M | O |
| 7.3 | Alert signal (also used for non-fire emergency) | O | O |
| 7.6 | Audible indication of alarm signal reception | M | O |
| 7.7 | Delay before emergency warning condition | X | X |
| 7.8 | Phased evacuation for multi-zoned systems | M | X |
| 7.9.1 | Silencing the emergency warning condition from the emergency detection system | O | O |
| 7.9.2 | Silencing the emergency warning condition with a manual control | O | O |
| 7.10.1 | Reset of the emergency warning condition from the emergency detection system | O | O |
| 7.10.2 | Reset of the emergency warning condition with a manual control | O | O |
| 7.11 | Output to warning devices | M | O |
| 7.12 | Emergency warning condition output signal | O | O |
| 8.3.5 | Earth fault | M [⊠] | M [⊠] |
| 8.4 | System fault | M [⊠] | M [⊠] |
| 9 | Disabled condition | O | O |
| 10 | Test condition and indication | M | O |
| 11 | Automatic/manual mode control | O | O |
| 11.2 | Manual control of distributed EWCIE | O | O |
| 12.1 | Individual emergency zone controls | O | O |
| 12.2.2 | All alert control | O | O |
| 12.2.3 | All live speech | O | O |
| 12.2.4 | All evacuate control | M | O |
| 12.4 | Indication of emergency zones in the fault warning condition | M [⊠] | M [⊠] |
| 13 | Interface to external device(s) | O | O |
| 14 | Emergency microphone | M | O |
| 15.15 | Redundant power amplifiers | O | O |

LEGEND:

M = mandatory function

O = optional function

X = shall not be provided

| | |
|---|---------------------|
| O | Option Included |
| O | Option not included |

Note: The EWCIE factory default is a Grade 3 system. By configuring phased evacuation sequences with the EvacUwiz configuration tool will change the EWCIE to a Grade 2 system.

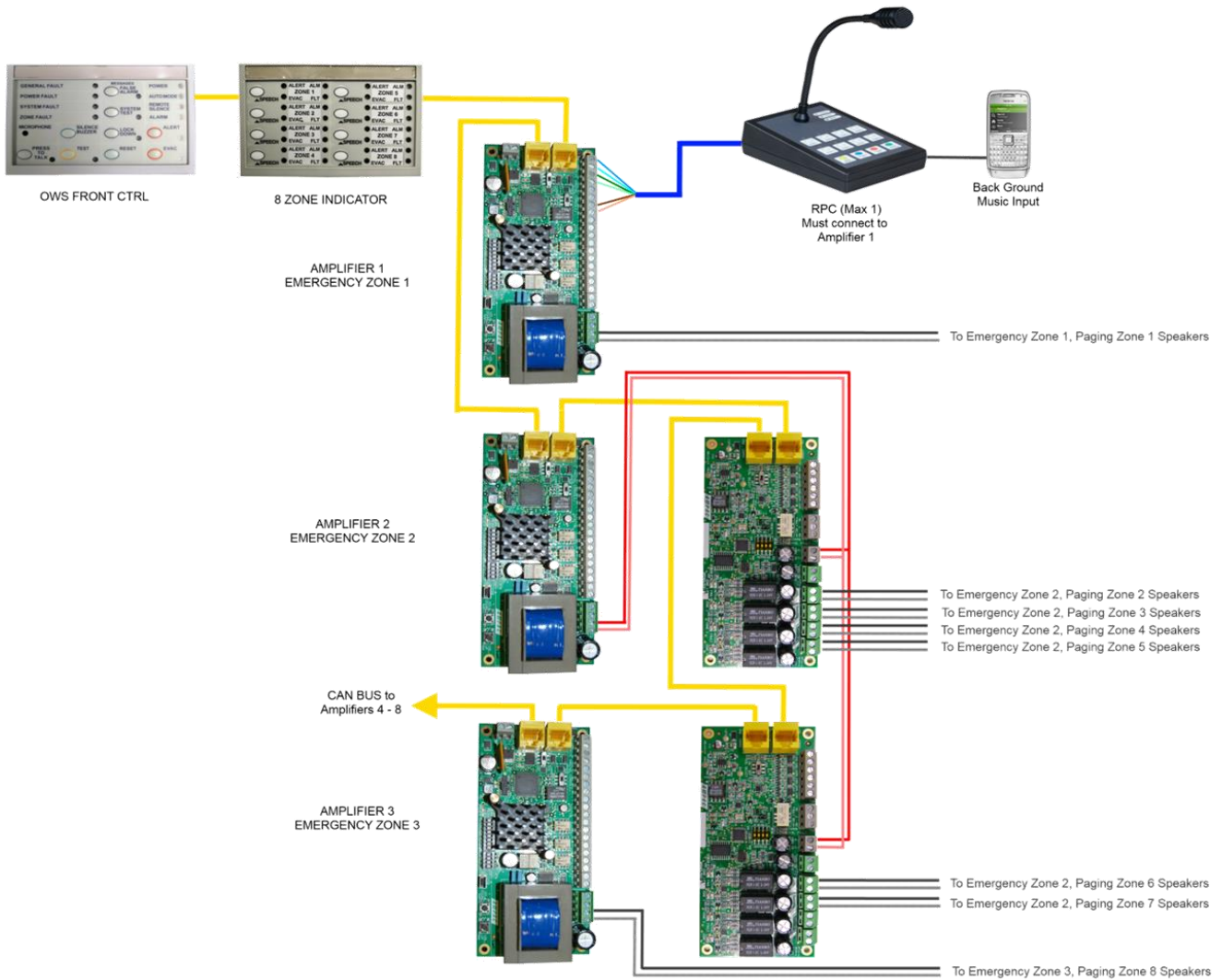

Figure 1: Typical EWCIE System

3 Specifications

| | 25Watt** | 50Watt** | 120Watt | 250W | 500Watt |
|---|--|-------------------------|------------------------------|---------------------|------------------------|
| Supply Voltage | 27VDC (nominal) | | | | 240Vac / 27Vdc |
| Max Audio Load | 25W | 50W | 120W | 250W | 500W * Requires ASL |
| Quiescent Current (no audio or strobe load) | 20mA | 20mA | 240mA | 380mA | 500mA |
| Max. Current (full audio load, no strobe load) | 1.19A | 2.39A | 8A | 17A | 35A |
| THD | 0.12% | 0.89% | <0.6% | <0.6% | <0.5% |
| Signal to Noise Ratio | 80.5dB | 82.1 dB | 91dB | 91dB | >90dB |
| Dimensions (mm) | 100(L)x77(W)x35(H) | | 170(L)x210(W)x85(H) | 300(L)x240(W)x95(H) | 483(W)x380(D)x88(H) |
| Strobe Output | Monitored 1A max, EOL 10kΩ 5% 1/3 Watt 8 Xenon sets (208-0011) or 40 LED sets (4107-10005) Cable Recommendation: Ampac TPS FLAT 2C 1.5MM, WH STRIPE or similar | | | | |
| 100V Audio Output | 100VAC, Monitored EOL Nominal 47kΩ 5% 1/3 Watt (2 branches use 100kΩ 5% ¼ Watt) Cable Recommendation: Ampac TPS FLAT 2C 1.5MM, WH STRIPE or similar | | | | |
| Alert / Evac Changeover time (secs) | Alert only, Evacuate only, 60, 90, 120, 180, 300 or under manual control via inputs (see section 5.2) | | | | |
| Alert Signal | To AS1670.1 and NZS4512 including voice message | | | | |
| Evac Signal | To AS1670.1 and NZS4512 including voice message | | | | |
| | Front Controls** | Zone Indicator** | Audio Line Splitter** | RPC** | |
| Quiescent Current | 10.5mA | 10.5mA | 10.5mA | 5.5mA | |
| Max Per System | 1 | 1 | 4 (2 max per amp) | 1 | |
| Emergency Zones | Up to 8 Emergency Zones can be configured and programmed | | | | |
| Paging Zones | Up to 8 Paging Zones can be configured and programmed. | | | | |
| Standalone Cabinet | PSU Options: 3A, 5A and 10A Colour: Surf-mist Dimension: 500mm (H) x 405mm (W) x 150mm (D) | | | | |
| Temp | -20°C to 70°C | | | | |
| Humidity | 0-95% non-condensing | | | | |

 **Note **** Denotes third party compliance to AS4428.16:2015

4 Front Panel Switch and Indicator Module

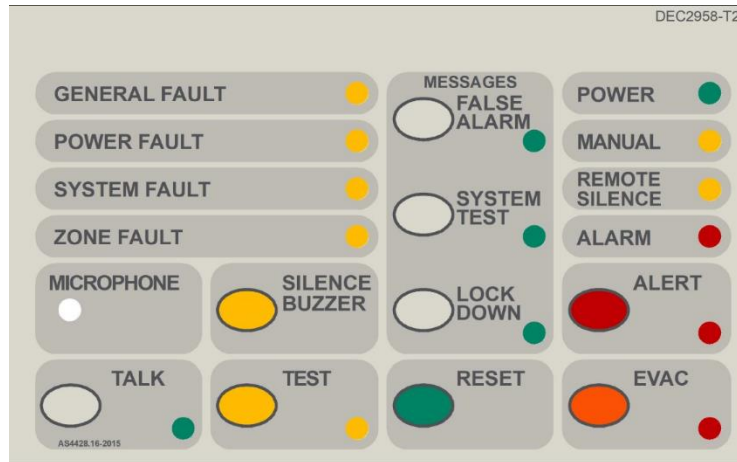

Figure 2: Front Panel Switch and Indicator Module

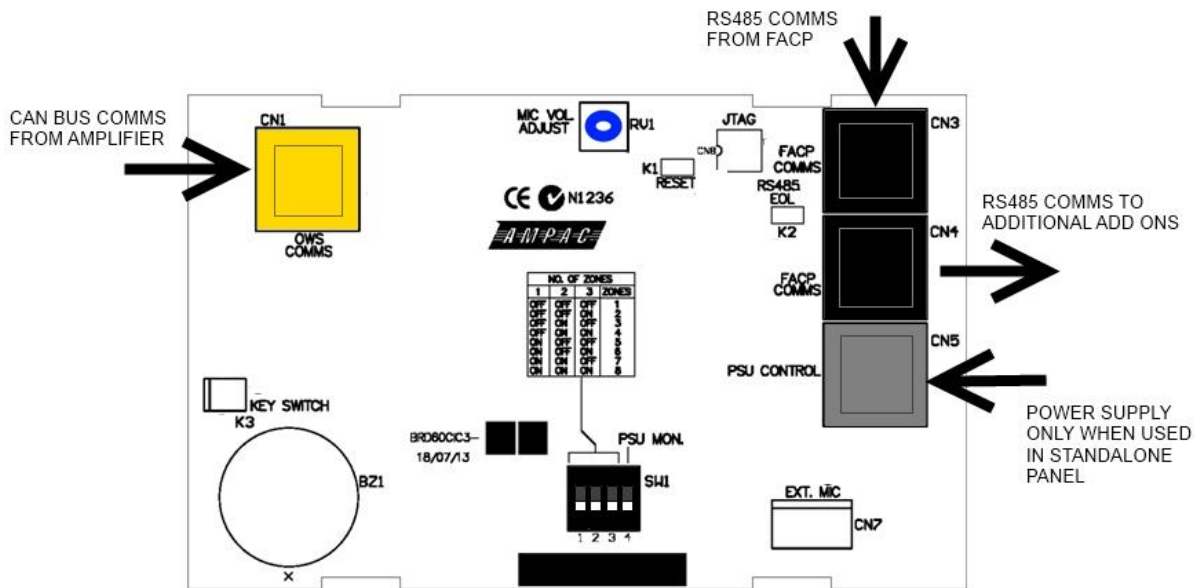

Figure 3: Front Panel Switch and Indicator Card PCB

4.1 Connectors

| | |
|-----------------|---|
| CN1 | CAN BUS communication between the Front Panel Switch and Indicator Card and the Amplifiers |
| CN3, CN4 | RS485 Add On communications when connecting the EWCIE to FireFinder Plus and LoopSense FACP's |
| CN5 | External Power Supply Monitoring. Required in the standalone version. |
| CN7 | Optional External hand held Emergency Microphone connection. |
| K1 | Not Fitted |
| K2 | RS485 EOL Link. Only fitted if the Front panel Switch and Indicator Card is the last Add-On Module fitted in the FACP. |
| K3 | Controls Enable. Default – fitted with a jumper link (controls always enabled). Can be connected to a key switch, for controls to be key activated. |
| RV1 | Used to adjust the microphone signal level so the sound is loud, clear and distortion free. Adjustment should be done before commissioning time. |

4.2 DIP Switch

The DIP switch (SW1) is 4-way and has the following options:

| | | | | | |
|----------------------------|---|---------------------------|------------|------------|------------|
| Switch 1, 2 & 3 | Sets the number of amplifiers fitted | Amplifiers | SW1 | SW2 | SW3 |
| | | 1 | OFF | OFF | OFF |
| | | 2 | OFF | OFF | ON |
| | | 3 | OFF | ON | OFF |
| | | 4 | OFF | ON | ON |
| | | 5 | ON | OFF | OFF |
| | | 6 | ON | OFF | ON |
| | | 7 | ON | ON | OFF |
| | | 8 | ON | ON | ON |
| Switch 4 | Enables PSU Monitoring (Required in standalone version) | Set On for PSU monitoring | | | |

4.3 Indicators

GENERAL FAULT



Steady when a fault condition is present on the EWCIE. Indicator is latched if there is a system fault.

SYSTEM FAULT



Steady when the EWCIE is preventing from functioning due to a hardware fault or communications between the Front Panel Switch and Indicator Card and the amplifier(s) has been lost. Indicator is latched.

POWER FAULT



Steady when any of the following conditions are present:

- Loss of mains voltage
- Loss of backup batteries
- Loss of battery charger or charger voltage outside allowable range
- Fault with the backup batteries – high internal resistance, high temperature, faulty connections

Otherwise the indicator is off.

ZONE FAULT 

Steady when there is a fault associated with the speaker circuit (short or interruption), strobe circuit (short or interruption) or amplifier, otherwise off.

POWER 

Steady when power is available to the EWCIE, flashing when mains voltage has not been detected, otherwise off.

MANUAL 

Steady when the EWCIE is in the Manual mode and the EWCIE is being controlled by an operator. When the MANUAL MODE indicator is Off, the EWCIE is in the AUTO mode, In the AUTO mode, the EWCIE will respond to an alarm signal from the connected fire alarm control panel.

REMOTE SILENCE 

Steady when the EWCIE has been silenced from the fire alarm control panel.

ALARM 

Steady when there is a fire alarm condition present on the connected fire alarm control panel. If the EWCIE is in the AUTO mode, then the EWCIE will respond to the alarm signal as per the amplifier digital inputs (section 5.2) and DIP switch settings (section 5.6).

ALERT 

Indicator flashing at ½ Hz when the alert signal has been activated as a result of the EWCIE responding to an alarm signal (from a connected fire alarm control panel) or operation of the ALERT control. If the EWCIE is in the TEST condition, the alert signal is NOT broadcast.

EVAC 

Indicator flashing at ½ Hz when the evacuate signal has been activated as a result of the EWCIE responding to an alarm signal (from a connected fire alarm control panel) or operation of the EVAC control. If the EWCIE is in the TEST condition, the evacuate signal is NOT broadcast.

When multiple amplifiers are fitted, the Alert and Evac indicators are used for ALL CALL only. Hence when all amplifiers are broadcasting the Alert signal, then the Alert indicator will be flashing, otherwise it will be off. Similarly, the Evac indicator will be steady when all amplifiers are broadcasting the Evac signal.



The buzzer sounds to announce a fault or alarm signal from the connected fire alarm control panel. Buzzer also used to provide audible feedback for key presses of the controls (one beep for a valid key press and a double beep for an invalid key press). There is no audible feedback on the PTT control.

4.4 Access Levels

Access levels are used to manage access to the front panel controls of the EWCIE.

Controls at access level #1 shall be accessible without special procedures

Controls at access level #2 shall be restricted by a special procedure.

In most cases the EWCIE will be mounted in the same cabinet as the fire alarm control panel, and the cabinet will have an outer door. A 003 key is required to unlock the door. Hence all controls on the EWCIE will be at access level #2.

In the rare case where the cabinet does not have an outer door, jumper K3 (see section 4.1 Connectors) has been provided to connect a key switch. When the key switch is ON (outputs shorted together), then the controls are enabled.

4.5 Controls

4.5.1 Press to talk



The Front Panel Control and Indicator card is fitted with an on-board microphone.

The Press to Talk (PTT) button - While pressed, the microphone is live (muting any other active audio source). The PTT control is operational at access level 2.

While the microphone is live, the PTT indicator (red LED) will be illuminated and any Alert or Evacuate LEDs will be extinguished. The PTT control on the microphone is the highest priority of all on-board controls. It shall override all other audio signals that are currently being broadcasted to the emergency zone.

4.5.2 Silence Buzzer



Silences the EWCIE's buzzer. Does not affect the buzzer of the connected fire alarm control panel.

Silencing the buzzer on the LoopSense or FireFinder PLUS fire alarm control panel will silence the buzzer on the EWCIE.



Note: Pressing the buzzer silence control for 3s or longer will initiate a Lamp Test on the Front Panel Control and Indicator card. During the Lamp Test, all indicators shall go steady and the buzzer shall sound continuously.

4.5.3 Test



Activating the TEST control places the EWCIE into the TEST condition.

There are three different Test Modes.

Test Mode 1:

Momentarily pressing the Test button places the EWCIE into Test Mode 1.

This test mode allows for testing the processing and indication of alarm input signals and manual controls for ALL Emergency Zones.

All audio (Alert, Evac, live speech and recorded messages) will NOT be broadcast to any Emergency Zones.

Test Mode 2:

Press and hold the Test button until the buzzer sounds twice and the Test indicator flashes twice (approx. 6 seconds) will place the EWCIE into Test Mode 2.

This test mode provides an Audible Test Tone that is broadcast to ALL Emergency Zones.

However, if a Zone Module is used, pre-selecting certain Zones by pressing the zones associated “Speech” button allows the Audible Test tone to be sent to the selected zones only instead of All zones.

Test Mode 3:

Press and hold the Test button until the buzzer sounds three times and the Test indicator flashes three times (approx. 12 seconds) will place the EWCIE into Test Mode 3.

This test mode when a Zone indicator module is used, provides the ability to place certain zones into a test state that allows the broadcasting of Alert, Evac, speech and recorded messages to the selected zones.

To remove the EWCIE from the TEST condition, activate the TEST control (toggle function) or activate the RESET control.

The EWCIE will only recognise the TEST control when it is NOT broadcasting any audio – including pre-recorded messages and live speech.

The Test control is operational at access level 2.

4.5.4 Messages

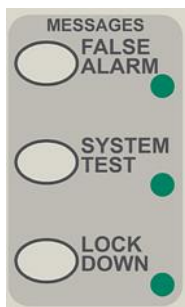

The FALSE ALARM, SYSTEM TEST and LOCKDOWN controls are used to broadcast pre-programmed messages.

Each control is latching, so once the control has been activated, the selected message will repeatedly broadcast.

The associated indicator is steady while the pre-recorded message is being broadcast.

To stop the broadcast at the completion of the current cycle, press the selected control and the associated indicator will flash. Once the current cycle is complete, the broadcast will stop and the associated indicator will be extinguished.

To stop broadcast immediately, activate the reset control.

The pre-programmed message controls are active at access level #2, and when the EWCIE is NOT broadcasting the alert signal, evacuation signal or live speech.

4.5.5 Reset



The RESET control is used to force the EWCIE to its default state.

Activating the reset control at any time will cause the following:

- Stops the broadcast of pre-recorded messages, alert or evacuate signal
- Extinguishes the ALERT and EVAC indicator
- Places the EWCIE to the AUTO mode (AUTO indicator goes steady)
- Removes the TEST condition (TEST indicator is extinguished)
- Extinguishes the SYSTEM FAULT and FAULT indicators

The RESET control is operational at access level 2.



Note: The RESET control has no effect on the remote silence function.



Note: The RESET control has no effect on the status of the FACP connected.

4.5.6 Alert



With the EWCIE in the AUTO mode (AUTO mode indicator steady), activating the ALERT control transfers the EWCIE from the AUTO mode to the MANUAL mode and broadcasts the alert signal.

The ALERT indicator goes steady and the AUTO MODE indicator is extinguished.

If the EWCIE is already in the MANUAL mode, then the ALERT control operates as a toggle. If the ALERT indicator is Off, then activating the control shall broadcast the alert signal and the ALERT indicator shall go steady.

If the ALERT indicator is On, then activating the control shall stop the broadcast of the alert signal and extinguish the ALERT indicator.

If the EWCIE is in MANUAL mode and broadcasting the evacuate signal (EVAC indicator is steady), then activating the ALERT control shall stop the broadcast of the evacuate signal, extinguish the EVAC indicator, commence broadcast of the alert signal and the ALERT indicator shall go steady.

If the EWCIE is in the TEST condition (TEST indicator is steady), then the alert signal is not broadcast.

The ALERT control is operational at access level 2.

4.5.7 Evac

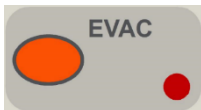

With the EWCIE in the AUTO mode (AUTO mode indicator steady), activating the EVAC control transfers the EWCIE from the AUTO mode to the MANUAL mode and broadcasts the evacuate signal.

The EVAC indicator goes steady and the AUTO MODE indicator is extinguished.

If the EWCIE is already in the MANUAL mode, then the EVAC control operates as a toggle.

If the EVAC indicator is Off, then activating the control shall broadcast the evacuate signal and the EVAC indicator shall go steady.

If the EVAC indicator is On, then activating the control shall stop the broadcast of the evacuate signal and extinguish the EVAC indicator.

If the EWCIE is in MANUAL mode and broadcasting the alert signal (ALERT indicator is steady), then activating the EVAC control shall stop the broadcast of the alert signal, extinguish the ALERT indicator, commence broadcast of the evacuate signal and the EVAC indicator shall go steady.

If the EWCIE is in the TEST condition (TEST indicator is steady), then the evacuate signal is not broadcast.

The EVAC control is operational at access level 2.

4.6 Emergency Microphone (Optional handheld)

A handheld Emergency Microphone can be connected to the EvacU. This microphone is connected to CN7 of the Front Control and Indicator module.

5 Amplifier Board (25W and 50W)

The Amplifier features 4 digital inputs, 3 relay outputs (1A), a strobe output and a 100VAC audio output.

The preprogrammed messages and tones are stored on the Amplifier board

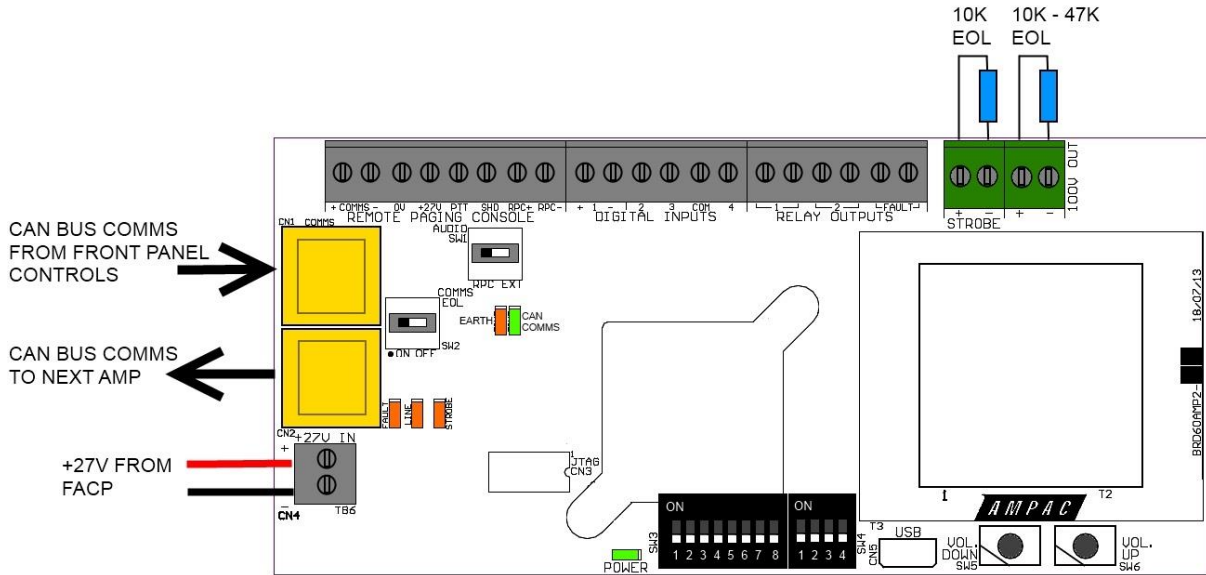

Figure 4: Amplifier Board

5.1 Remote Paging Console Terminals

The Remote Paging Console Terminals are as follows:

| | |
|--------------------|--|
| + COMMS - | RS485 communications to the RPC |
| 0V and 27V | +27V and 0V, 100mA power output for RPC |
| PTT | Push to Talk Input. Operates by shorting to 0V |
| SHD | Screen Termination terminal. 0V |
| RPC + and - | External Microphone or Background music input |

i The 8 Zone Paging console must always be connected to the Amplifier that is set as Communication Address 0 Emergency Zone 1 (see Section 5.6).

i When connecting the 8 Zone paging console and more than one amplifier is being used and requires remote paging the “Audio SW” located on each of the amplifiers must be set to the “EXT” position.

5.2 Digital Inputs

The digital input functions vary depending on the Country Standard (Region) Dip Switch 2 & 3 settings and the setting of Dip Switches 5, 6 & 7.



Note: These inputs can be hardwired or controlled via the Ampac Fire panel RS485 communications bus.

5.2.1 The Primary (Default) settings:

| Region Dip Switches 2 & 3 Set to either AS or NZ, Dip Switches 5, 6 & 7 set to any state except On (1) On (1) On (1) refer section 5.6. | | |
|--|--------------------------|--|
| Input 1(+/-) | Bell/Trigger Input (FIB) | Active high input. Tie to 24V to activate (non-latching); 10kΩ load opens on fault; (Connect to FireFinder and ZoneSense Plus FACP's Warning System Output) |
| Input 2 | Reset | Active low input. Short to 0V to activate (non-latching). |
| Input 3 | Silence | Active low input. Short to 0V to activate (non-latching). |
| Input 4 | External Fault | Active low input. Short to 0V to activate (non-latching). |

5.2.2 The Secondary settings:

| Region Dip Switches 2 & 3 Set to either AS or NZ, Dip Switches 5, 6 & 7 must be set to On (1) On (1) On (1) refer section 5.6. | | |
|---|--|--|
| Input 1(+/-) | Configurable see EvacUwiz Programming Manual MAN3084 Default is Trigger Input (FIB) | Active high input. Tie to 24V to activate (non-latching); 10kΩ load opens on fault; (Connect to FireFinder and ZoneSense Plus FACP's Warning System Output) |
| Input 2 | Configurable see EvacUwiz Programming Manual MAN3084 Default is Evacuate | Active low input. Short to 0V to activate (non-latching). |
| Input 3 | Configurable see EvacUwiz Programming Manual MAN3084 Default is Alert | Active low input. Short to 0V to activate (non-latching). |
| Input 4 | Configurable see EvacUwiz Programming Manual MAN3084 Default is Custom Tone 400/450Hz @ 0.5Hz | Active low input. Short to 0V to activate (non-latching). |

5.2.3 Custom setting (NZ Special):

| | | |
|---------------------|--|--|
| | Region Dip Switches 2 On (1) & 3 On (1) – Custom Configuration Dip Switches 5, 6 & 7 must be set to On (1) On (1) On (1) refer section 5.6. | |
| Input 1(+/-) | NZ Evac Sequence | Active high input. Tie to 24V to activate (non-latching); 10kΩ load opens on fault; (Connect to FireFinder and ZoneSense Plus FACP's Warning System Output) |
| Input 2 | NZ Alert Sequence | Active low input. Short to 0V to activate (non-latching). |
| Input 3 | NZ School Bell | Active low input. Short to 0V to activate (non-latching). |
| Input 4 | NZ Lockdown Sequence | Active low input. Short to 0V to activate (non-latching). |

5.3 Relays

The Relays are rated to 1A @ 24VDC and function as follows:

| | | |
|----------------|-----------------------------|---|
| Relay 1 | Emergency Warning Condition | Enabled: Relay Closed (energised) Disabled: Relay Open (de-energised) No Power: Relay Open (de-energised) |
| Relay 2 | Test Mode | Enabled: Relay Closed (energised) Disabled: Relay Open (de-energised) No Power: Relay Open (de-energised) |
| Fault | Fault Relay | Fault: Relay Open (de-energised) No Fault: Relay Closed (energised) No Power: Relay Open (de-energised) |

5.4 Strobe Output

The Strobe Output functions as follows:

| | |
|---------------|---|
| Strobe | <p>Provides a Bi-polar output for driving Visual Warning Devices.</p> <p>The output is monitored and requires 10kΩ 5% 1/3Watt EOL.</p> <p>Allows for 8 x Ampac Xenon Strobes (208-0011) or 40 x Ampac LED strobes 4107-1005/6)</p> <p>Cable Recommendation: Ampac TPS FLAT 2C 1.5MM, WH STRIPE or similar</p> |
|---------------|---|

5.5 Audio Line Output

The 100V Audio Line Output functions as follows:

| | |
|-----------------|--|
| 100V Out | <p>Provides a 100VAC Audio Output. Supports up to 2 branches.</p> <p>The output is monitored and requires an EOL value of 47kΩ 5% 1/3 Watt. For 2 branches use 100kΩ 5% ¼ Watt on each branch.</p> <p>Speaker recommendation: 100V with capacitor for DC Monitoring</p> <p>Cable recommendation: Ampac TPS FLAT 2C 1.5MM, WH STRIPE or similar</p> |
|-----------------|--|

5.6 DIP switch settings

The Amplifier has two DIP switches Configuration switches (SW3) and Address Switches (SW4)

The Configuration DIP switch (SW3) is 8-way and has the following options:

| | | |
|----------------------------|---|---|
| Switch 1 | Commissioning Mode <i>*(Dynamic)</i> | Set to On (1) for Commissioning Mode Off (0) for Operation Mode Default is On (1) Refer to 5.8 volume controls for detail on commissioning mode |
| Switch 2 & 3 | Country Standard <i>*(Start Up)</i> | 2 Off (0) & 3 Off (0) – AS1670.1:2015 2 Off (0) & 3 On (1) – NZS4512:2010 2 On (1) & 3 Off (0) – N/A 2 On (1) & 3 On (1) – Custom Configuration Default is switch 2 and 3 Off |
| Switch 4 | Background Music Mode <i>*(Dynamic)</i> | Set to On (1) to enable the RPC (+ and -) audio inputs to be used for background music. |
| Switch 5, 6 & 7 | Alert/Evac Timeout & Custom Input settings <i>*(Start Up)</i> | Configures how the EWCIE responds to the alarm signal Option 5,6,7 0. (000) 0s timeout – Evac signal only 1. (001) 60s Alert signal, then Evac signal 2. (010) 90s Alert signal, then Evac signal 3. (011) 120s Alert signal, then Evac signal 4. (100) 180s Alert signal, then Evac signal 5. (101) 300s Alert signal, then Evac signal 6. (110) no timeout – Alert signal only 7. (111) Set for Custom Input Configuration - refer to EvacUwiz Programming Manual MAN3084. |
| Switch 8 | Earth Fault detection. Stand Alone Panel Only <i>*(Dynamic)</i> | Set to On (1) for Detect Earth Fault; Off (0) to Disable. Default is Off (0). |

The Address DIP switch (SW4) is 4-way and has the following options:

| | | |
|---------------------------|---|---|
| Switch 1,2 & 3 | Communication Address <i>*(Start Up)</i> | Local Amplifier Address (valid range is 0 to 7); Set to a unique valid address for each EWCI connected to the Local Bus (CAN). Option 1,2,3 0. (0 0 0) Emergency Zone 1 1. (0 0 1) Emergency Zone 2 2. (0 1 0) Emergency Zone 3 3. (0 1 1) Emergency Zone 4 4. (1 0 0) Emergency Zone 5 5. (1 0 1) Emergency Zone 6 6. (1 1 0) Emergency Zone 7 7. (1 1 1) Emergency Zone 8 Default is 0; First amplifier must be 0. |
| Switch 4 | Communication Monitoring <i>*(Dynamic)</i> | Set to On (1) to enable monitoring of the communications path between the amplifier and an associated front panel. Set to On (1) if a front panel switch and indicator card is fitted. A general fault (indicator and relay) will be activated if communications is lost with the front panel. Should be set to Off (0) if no front panel is fitted. |



Note: Note that the statuses of some switches are only read at system *startup*, while others are *dynamically* updated throughout the execution of the application code. In order for the switches marked as **(Start Up)* to have changes in their state acknowledged, the system must be restarted, either through a valid power cycle or software/hardware reset.

5.7 LED indications

The amplifier has the following indicators:

| Indicator | Colour | Description |
|-----------------------|--------|---|
| Power | Green | Steady when power available. Controlled by hardware |
| General Fault | Amber | Steady with a fault condition: Zone fault, Power fault or System fault, otherwise steady |
| Line fault | Amber | Steady when speaker circuit has an interruption, flashing when speaker circuit is overloaded / shorted, otherwise off |
| Strobe fault | Amber | Steady when strobe circuit has an interruption, flashing when strobe circuit is overloaded / shorted, otherwise off |
| Earth fault | Amber | Steady when an earth fault is present, otherwise off |
| CAN Bus Communication | Green | Flashes when communications is present. |

A lamp test can be initiated by pressing the Volume Up and Volume Down buttons simultaneously for 3s. The Lamp Test can only be initiated from the amplifier while not in commissioning mode.

5.8 Volume Controls

The amplifier has volume controls, SW5 (down) and SW6 (up) located on the amplifier board. These volume control buttons are only active when in commissioning mode. The factory default volume is 0 dBA.

In order to save the volume setting for each audio source, place the amplifier in the operational mode.

(Refer to DIP Switch Settings)

| Type | Description |
|-------------|--|
| UP Button | Increases the volume of the currently activated audio source. Each step represents 1 dB and there are 64 steps from 0dBA to -63dBA |
| DOWN Button | Decreases the volume of the currently activated audio source. Each step represents 1 dB and there are 64 steps from 0dBA to -63dBA |

Note: There are three volume control settings available for editing and storage; they are:

System setting – This is the volume setting that applies to all system messages, whether they be alarms, alerts, test messages, etc and the microphone level. When in commissioning mode and any system message or tone is being played then adjusting the volume will adjust the volume settings for the ‘system’ volume type. You must exit commissioning mode for this setting to be saved.

Background music setting – This volume setting applies to background music and can only be adjusted whenever background music is playing while in commissioning mode. You must exit commissioning mode for this setting to be saved.

RPC (Remote Paging Console) setting – This volume setting applies to the RPC microphone input and can only be adjusted when in commissioning mode and whenever the RPC microphone input is active. You must exit commissioning mode for this setting to be saved.

5.9 System Messages

The EWCIE amplifier/tone-generator shall have standard system messages programmed by default.

They cannot be overwritten. These messages are shown in the table below.

| Message | Length | Description |
|-------------|--------|--|
| Evacuation | | “Emergency – Evacuate Now” (for AS1670.1 and NZS4512) |
| Alert | 6s | “An incident has been detected in the building – please prepare to evacuate and wait further instructions” (for AS1670.1 and NZS4512) |
| False Alarm | 8s | “May I have your attention please – A false alarm has been detected. The all clear is now given. Thank you for your patience and understand” |
| System Test | 4s | “This is a fire alarm test” |
| Lockdown | 3s | No Message (tone only) |

5.10 Custom Messages

The EWCIE can have custom messages programmed. For details on how to program and use custom messages refer to section 9 and 10 of the OWS Programming Manual MAN3084.

5.11 Tones

The Australian or New Zealand tones are determined by the Dip switches 2 and 3 (Country Standard).

The default Australian tones for Alert and Evac are the AS1670.1-2015 tones. If the AS1670.1-2004 tones are required this must be set by using the EvacUwiz programming tool.

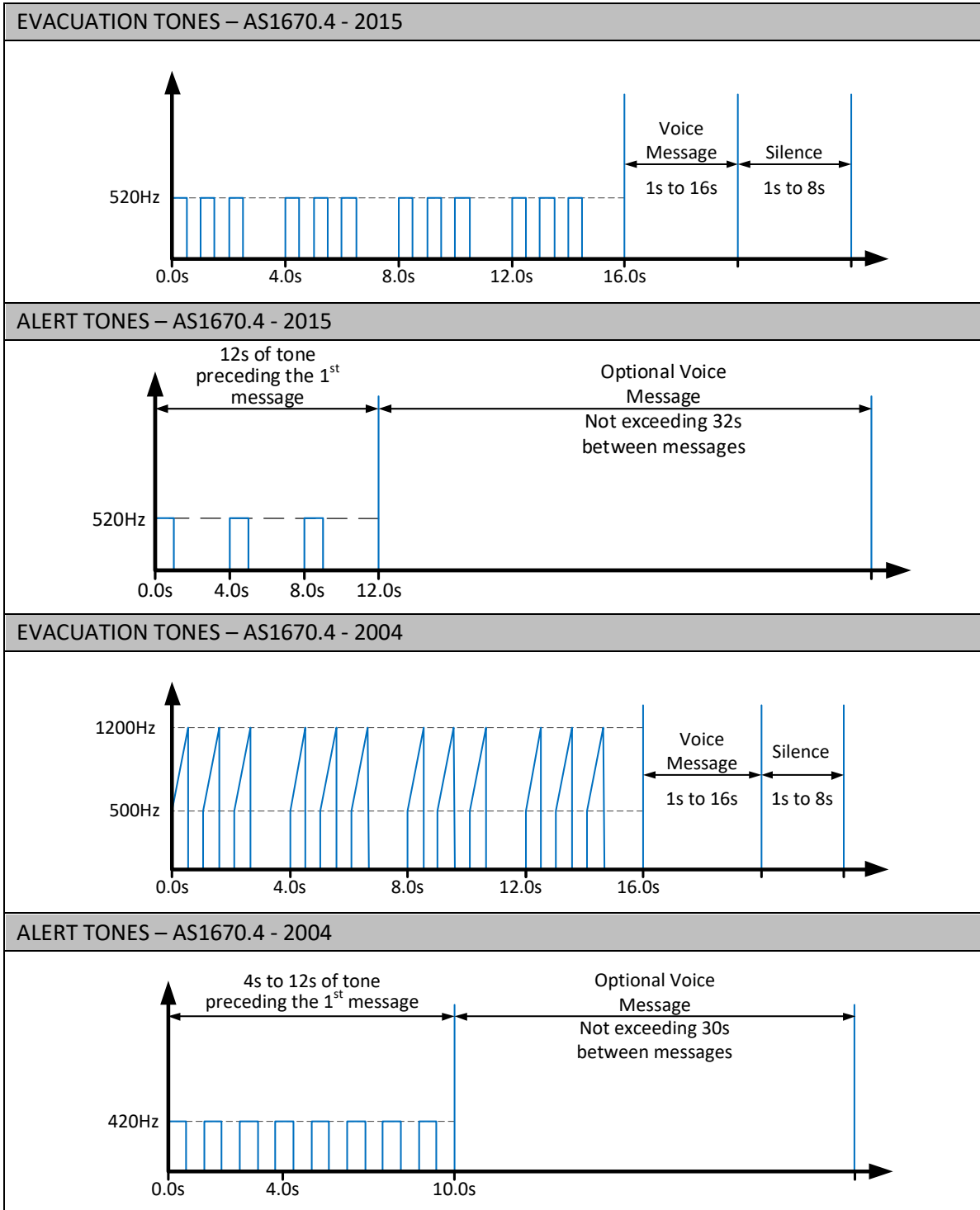

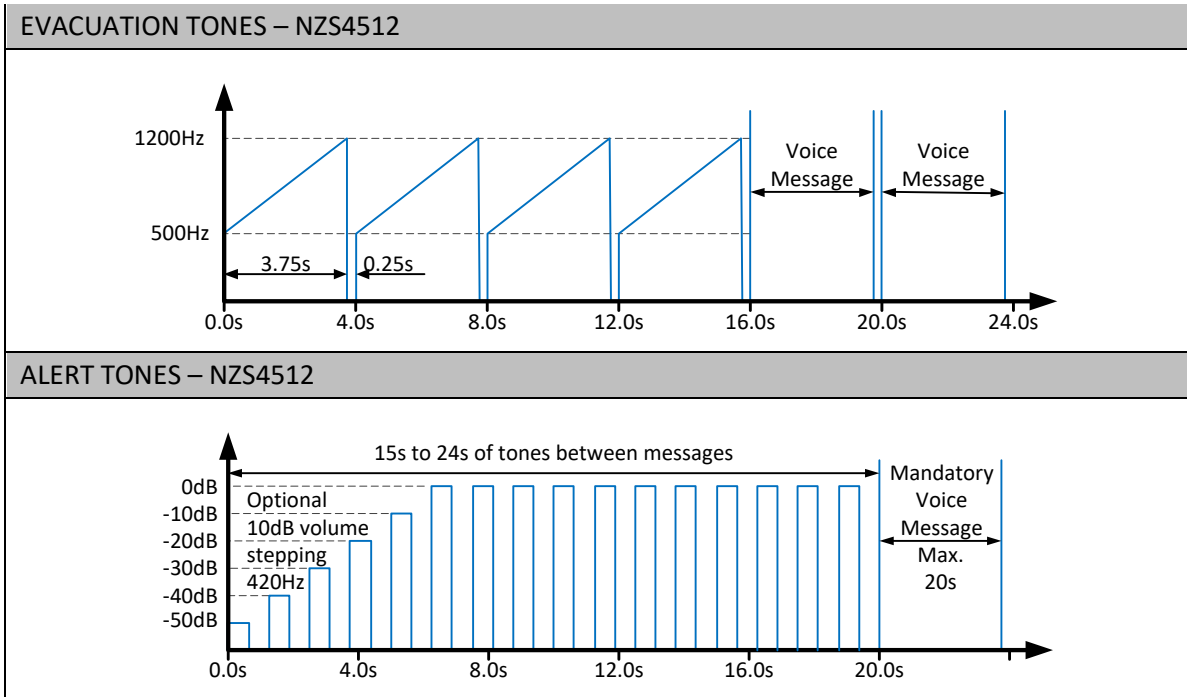

Figure 5: Alert & Evacuation Signal Structures

6 Tone Generator (120W, 250W and 500W)

The Tone Generator is used to interface to the larger 120W, 250W and 500W amplifiers or other third party amplifiers where applicable.

Note: The operation and functionality of the 120W, 250W and 500W complies with AS4428:16, however these amplifier variants have not been third party approved.

The Tone Generator board provides the same features found on the 25W and 50W amplifiers such as:

- 4 digital inputs,
- 3 relay outputs (1A),
- Remote paging interface,
- a strobe output,
- 100VAC audio output,
- LED indications,
- Volume Controls,
- Messages and
- Tones.

All programming, configuring and settings are as per the amplifier board.

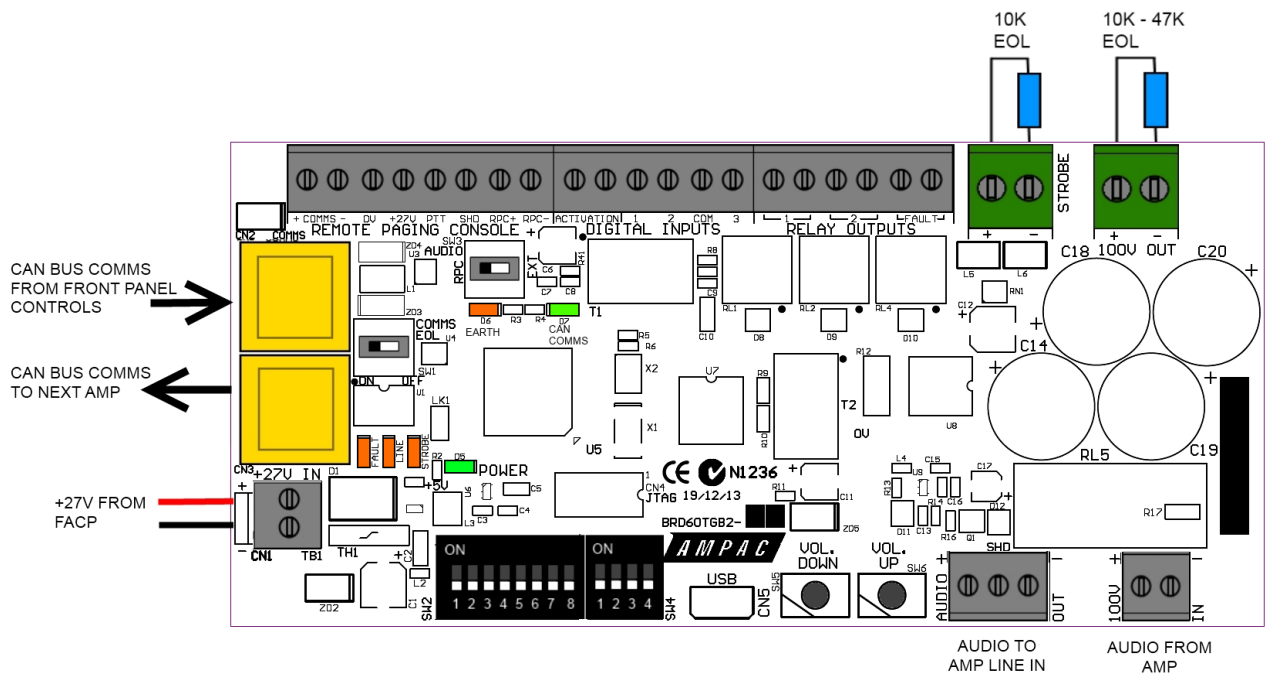

Figure 6: Tone Generator Board

Note: The Tone Generator's 100V Speaker line output can only accommodate 250W of speaker load.

Therefore, when using the 500W amplifier an Audio Line Splitter must be used to be able to utilise and distribute the full 500W.

7 Zone Indicator Module

The Zone Indicator module is used to indicate the status of the EWCIE when more than one and up to a maximum of eight Emergency Warning Zones (8 amplifiers) have been configured in the system.

The module also allows individual zone selection for individual emergency zone announcements and system messages (False Alarm, System Test and Lock Down).

 **Note:** Alert and Evac are “ALL CALL” and override the manual selection.

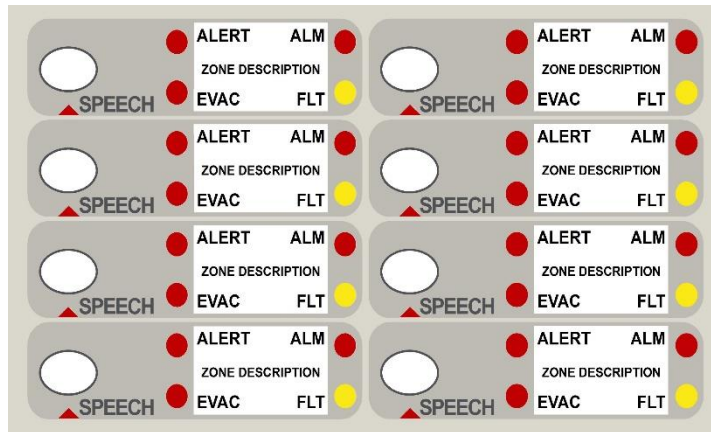

Figure 7: Zone Indicator Module

 **Note:** Use LAB3134 editable slip in label for custom Zone Descriptions

7.1 Connectors

| | |
|------------|---|
| CN1 | CAN BUS communication and power to and from the Front Panel Switch and Indicator Module |
| CN2 | CAN BUS communication and power to and from the Amplifiers |

7.2 Indicators and Controls

 **ALERT**

On steady when the associated emergency zones are in the Alert condition.

 **EVAC**

On steady when the associated emergency zones are in the Evacuate condition.

 **ALM**

On steady when the associated emergency zones are in the Alarm (Evacuate or Alert) condition.

 **FLT**

Flashes when the associated emergency zone is in fault. On steady when the associated emergency zone is in the test condition.



Emergency zone “Speech” (Toggle) selection switches are used to manually select the individual emergency zones to communicate to when using the PTT microphone on the Front Control & Indicator module.

Additionally, the switch allows for system messages (False Alarm, System Test and Lockdown) to be played to individual emergency zones.

If no zones are selected the PTT operates as an ALL CALL microphone and all emergency zones will be turned on for speech.

The Speech LED is on steady when the associated emergency zone has been selected.

 **Note:** Pressing the buzzer silence control for 3s or longer on the Front Panel Control and Indicator Module will initiate a Lamp Test on the Zone Indicator Module. During the Lamp Test, all indicators shall go steady

8 Audio Line Splitter (ALS)

The Audio Line Splitter allows an amplifier’s 100V line output to be split into four monitored branches.

A single monitored branch can deliver up to 100Watts of audio load.

However, the combined total audio load of the four branches is limited to a maximum of 250Watts.

All four branches of the ALS are associated to the same Emergency Zone, which is determined by the connected amplifier settings.

Each branch can be configured to have different Paging Zones when a Remote Paging Console is connected to the system and the ALS is connected over the CAN bus.

A maximum of two ASL’s can be connected to a single Amplifier, with a combined maximum of four per system when configured using the EvacUwiz and CAN bus communications.

If more than two ASL’s are required per Amplifier then they can not be configured in the EvacUwiz or connected on the CAN bus.

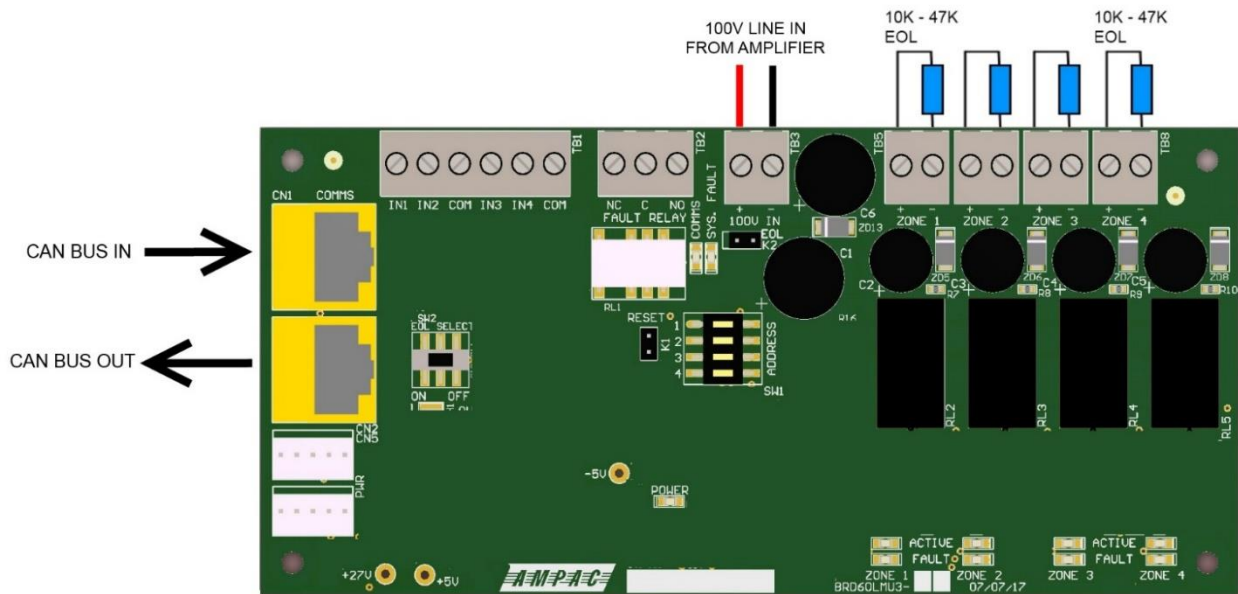

Figure 8: Audio Line Splitter (Version 3 shown)

8.1 LED indications

The Line Monitor Unit has the following indicators:

| Indicator | Colour | Description |
|---------------------|--------|--|
| Power | Green | On steady when power available. Controlled by hardware |
| Sys. Fault | Amber | On steady with any fault condition, otherwise Off. |
| Comms | Green | Flashes when the can bus communications between the module and other EWCIE components is active. |
| Zone Fault (1 - 4) | Amber | On steady when applicable zone speaker line is open. Flashes when applicable zone speaker line is overloaded / shorted, otherwise off. |
| Zone Active (1 – 4) | Red | On Steady when applicable zone line is active. Activity includes Remote paging, Background Music, Emergency PTT paging and zone in alarm. |

8.2 Inputs

The Audio Line Splitter has the following inputs:

| Input | Description |
|-------------------------|---|
| IN1 - IN4 (TB1) | These inputs are used to manually active the applicable Zones 1-4 when using 3 rd party paging consoles. (See DIP switch setting 8.5 below) Active low input. Short to 0V to activate (non-latching). |
| 100V in BRD60AMP (TB3) | Version 3 Splitter (BRD60LMU3) For the 25W, 50W or 120W amplifiers 100V line out then EOL K2 link must be fitted to last splitter. For the Tone generators on 250 and 500W 100V line out then do not fit EOL K2 link. Version 2 Splitter (BRD60LMU2) If the ASL is being connected to the 25W, 50W or 120W amplifiers, the 100V line out from the Amplifier (25W & 50W) or Tone Generator (120W) is to be connected here. |
| 100V in From TXFR (TB4) | Version 2 splitter boards (BRD60LMU2) Only If the ASL is being connected to the 250W or 500W amplifiers, the 100V line out from the amplifier is to be connected here |



Note: When 3 or more (Max is 6) ASL board's are used or the inputs are hardwired, the DIP switch settings 0, 13, 14 and 15 are used to determine the operation of the ASL inputs (Refer to DIP switch settings below).

8.3 Relay Output

The Audio Line Splitter has a single relay output:

| Output | Description |
|-------------------|-------------------------------------|
| Fault Relay (TB2) | Fault: Relay Open (De-energised) |
| | No Fault: Relay Closed (Energised) |
| | No Power: Relay Open (De-Energised) |



Note: When 3 or more ASL boards are used, the DIP switch settings 0, 13, 14 and 15 are used to determine the operation of the ASL fault relay (Refer to DIP switch settings below).

8.4 Audio Line Outputs

The four split line outputs function as follows:

| | |
|------------------|---|
| Zones 1-4 | Provides 4 x 100VAC 100W maximum Audio Outputs. Combined total of the four outputs should not exceed 250W. Each output is monitored. EOL value is between 10K - 47kΩ 5% 1/3 Watt. |
|------------------|---|

8.5 DIP switch settings

Address DIP switch settings.



Note: Addresses 1-4 to be used only with CAN bus monitoring.

Addresses 5 to 12 are not used.

Addresses 0, 13, 14 and 15 are used when the ASL's inputs and fault output are hardwired (This option is when there are 3 to 6 ASL's required).

The table below shows the applicable settings.

| Switch 1 | Switch 2 | Switch 3 | Switch 4 | Description |
|----------|----------|----------|----------|--|
| OFF | OFF | OFF | OFF | No CAN bus - Normal |
| ON | OFF | OFF | OFF | CAN bus Address 1 |
| OFF | ON | OFF | OFF | CAN bus Address 2 |
| ON | ON | OFF | OFF | CAN bus Address 3 |
| OFF | OFF | ON | OFF | CAN bus Address 4 |
| ON | OFF | ON | OFF | Address 5 – Not used |
| OFF | ON | ON | OFF | Address 6 - Not used |
| ON | ON | ON | OFF | Address 7 – Not used |
| OFF | OFF | OFF | ON | Address 8 – Not Used |
| ON | OFF | OFF | ON | Address 9 – Not Used |
| OFF | ON | OFF | ON | Address 10 – Not Used |
| ON | OFF | OFF | ON | Address 11 – Not Used |
| OFF | OFF | ON | ON | Address 12 – Not Used |
| ON | OFF | ON | ON | No CAN bus – Inverted Inputs |
| OFF | ON | ON | ON | No CAN bus – Inverted fault, Inverted Inputs |
| ON | ON | ON | ON | No CAN bus – Inverted Fault |

9 8 Zone Remote Paging Console

The 8 Zone Remote Paging Console allows remote paging to up to eight Zones.

Additionally, the Paging Console provides a 3.5mm Audio jack so that a background music source can be connected to the EWCIE system.



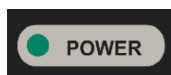

9.1 Indicator and Controls

- 

ON steady when power is available to the EWCIE, otherwise OFF
- 

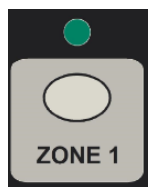
ON steady when there is a EWCIE fault, otherwise OFF
- 

ON steady when and System Messages, Alert or EVAC and emergency PTT paging is present, otherwise OFF
- 

The ZONE select buttons are used to select individual zones to page to.
The button is also used to select which zones background music is channelled to when the BGM select button is pressed.
Selections are latched ON and the Green LED is ON steady
- 

The PUSH TO TALK button is used to open the speech line once paging Zones have been select. The button is momentary and requires the user to keep it pressed during paging.
The Green LED is ON steady when button is pressed.
- 

The SELECT ALL button selects all eight zones for paging. The button is latching.
- 

The CLEAR ALL button deselects any previously selected zones.
- 

The BGM SELECT button allows the user to program which zones receive the background music input. Selection is done by pressing and holding the BGM switch and then selecting the applicable zone buttons.
Selected Zone indicators flash to indicate the zone has BGM.

9.2 RPC Connection

ⓘ The RPC console must always be connected to the Amplifier that is set as Communication Address 0, Emergency Zone 1 (see Section 5.6).

Connection to the amplifier is done using CAT5 “A” RJ45 cable. The maximum cable length should not exceed 100m.

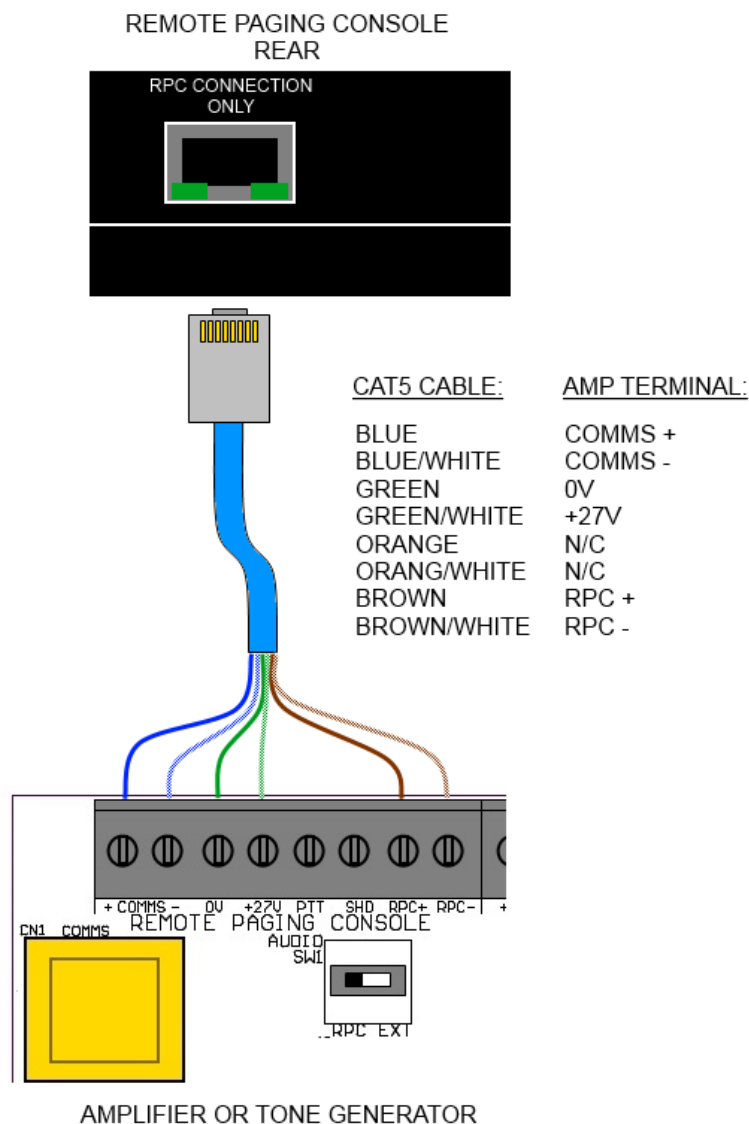

Figure 9: Remote Paging Console connection

ⓘ When connecting the 8 Zone paging console and more than one amplifier is being used and they each require remote paging functionality the “Audio SW” located on each of the amplifiers must be set to the “EXT” position.

In this mode background music is a common source provided from the RPC BGM input.

10 Standalone Panels

The EWCIE is available as a fully contained, battery backed standalone panel.

The standalone panel consists of a Front Panel Switch and Indicator module, a PSU an optional Zone Indication Module and can accommodate a combination of 25W Amplifiers, 50W Amplifiers and Line Monitoring Units to suit single or multiple zone installations.

10.1 The Cabinet

Features:

- The cabinet is capable of being either surface or flush mounted. When flush mounted a separate surround is required.
- Normally painted Surfmist. Other colours are available on request.
- The inner and outer door hinges are mounted on the left-hand side of the cabinet which allow the doors open to an angle of 100°.
- Outer door is locked using the standard 003 key.
- Knockouts are positioned at the top and rear of the cabinet to simplify cable entry. The larger range of cabinets use a removable gland plate to allow for the greater amount of cabling

10.2 Mounting the Cabinet



Note: *It is recommended the cabinet should be installed in a clean, dry, vibration-free area.*

Open the front door. Use the keyhole mounting holes in the top corners and in the lower middle of the unit to mount it on the wall. Cables to connect the system to its external actuating devices are brought in through the knockouts on the top or bottom of the cabinet.

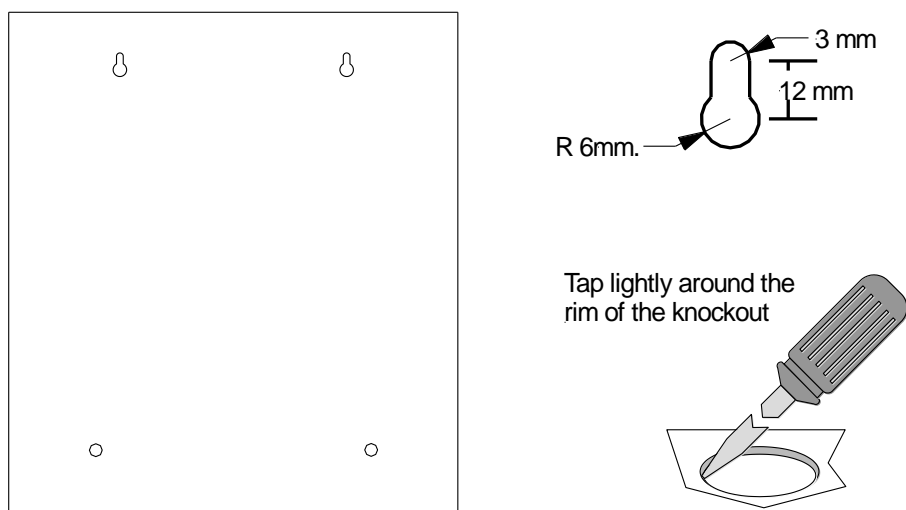

Figure 10: Example SP1X Back Pan Mounting Hole & Removing Knockouts

10.3 Panel General Layouts

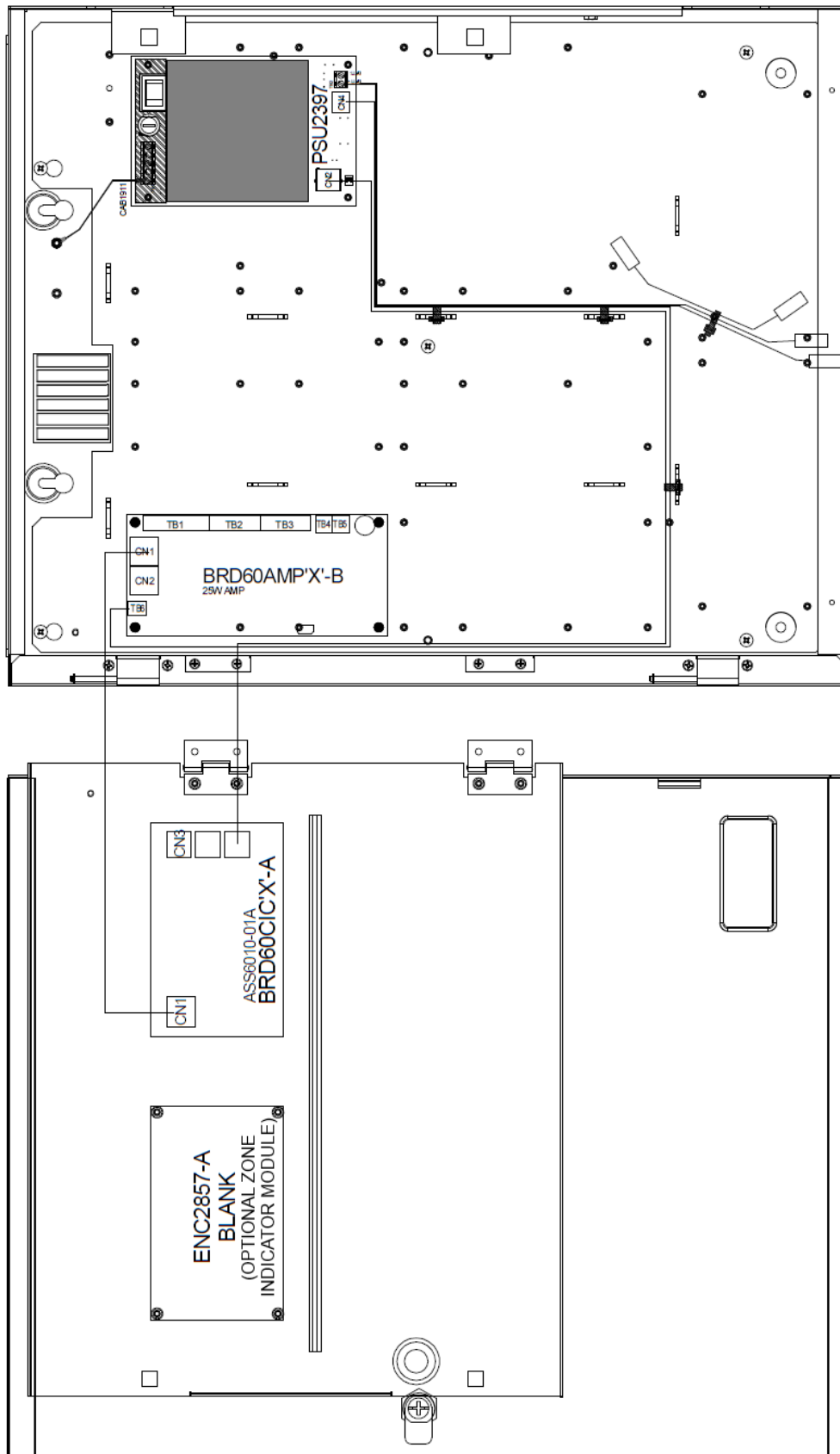

Figure 11: Standalone 25W with 3Amp PSU shown

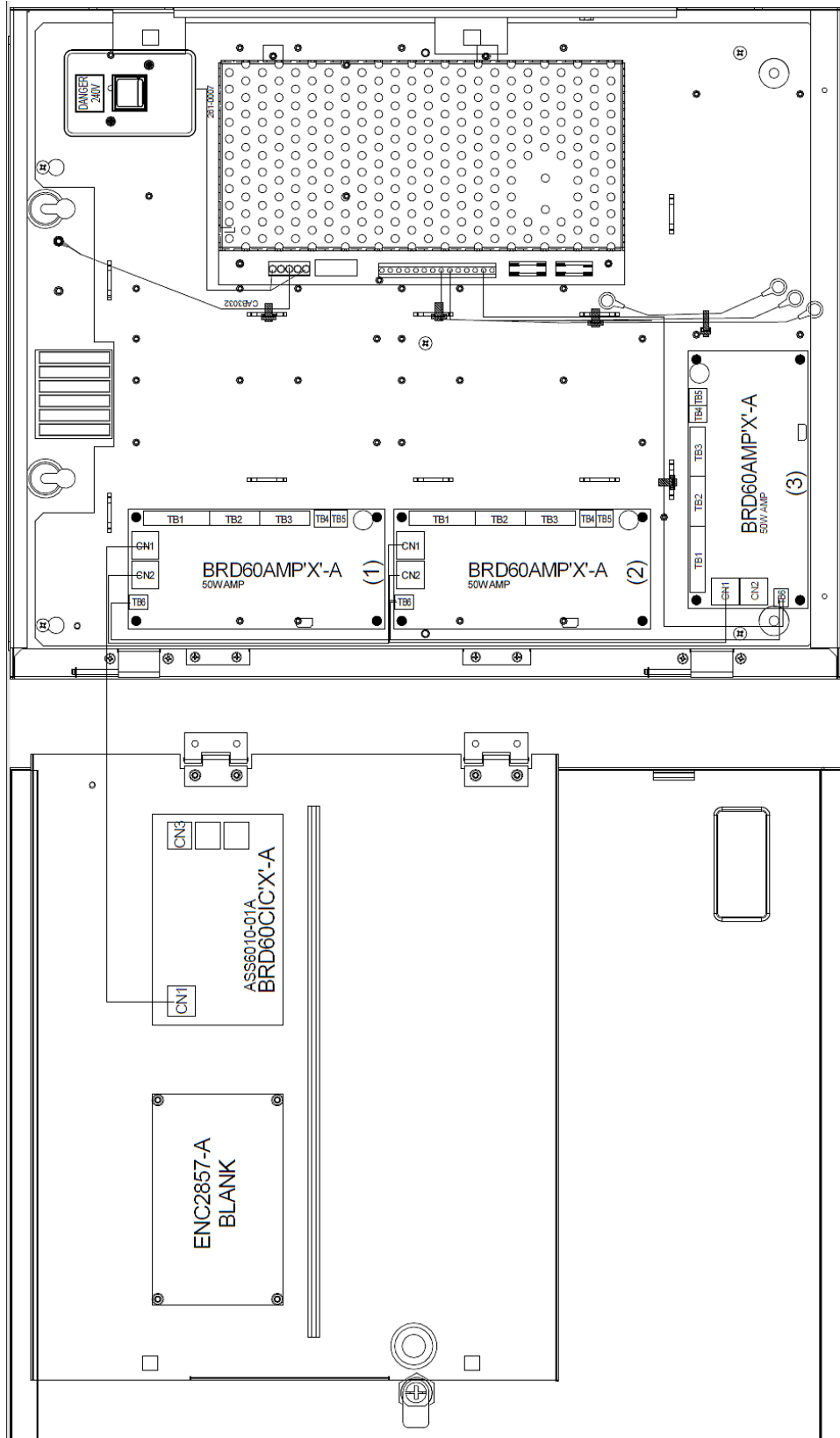

Figure 12: Standalone 3 x 50W with 10Amp PSU shown

10.4 Power Supply Specifications

The Standalone EWCIE can use three different power supplies depending on the number and size of the amplifiers installed.

| | 3 Amp | 5 Amp | 10 Amp |
|------------------------|----------------------|---------------------------|--------------------------|
| Mains Input | 204 – 264Vac | 110-240Vac | 110-240Vac |
| Mains Protection/Fuse | 2 Amp M205 | T3.15 A 20mm, 250V ac HRC | T4.0 A 20mm, 250V ac HRC |
| Cable Requirements | >0.75mm ² | | |
| Voltage Output (Mains) | 25-29Vdc | 27.0 – 28.3V dc | 27.0 – 28.3V dc |
| Battery Standby | | 20.3 – 26.0V dc | 20.3 – 26.0V dc |
| Ripple Voltage | <100mV | <100mV | <100mV |
| Imax A | 3 Amp | 5 Amp | 10 Amp |
| Protection/Fuse | Current Limiting | F5.0 A | F10.0 A |
| Battery Size | 2 x 7 or 12 Ah 12V | 2 x 12 or 18 Ah 12V | 2 x 18 Ah 12V |
| Charge Current | 600 mA | 850 mA | 700 mA |
| Battery Low | 23.5V | 23V | 23V |
| Notes** | | | ** Battery Box Required |

10.4.1 3 Amp PSU

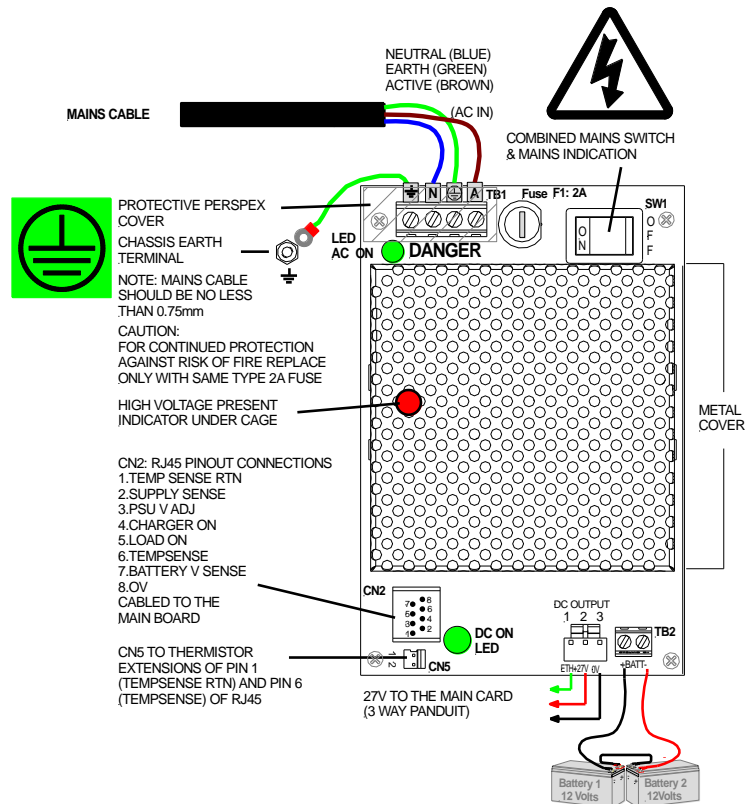

Figure 13: 3 Amp PSU shown

10.4.2 5 Amp PSU

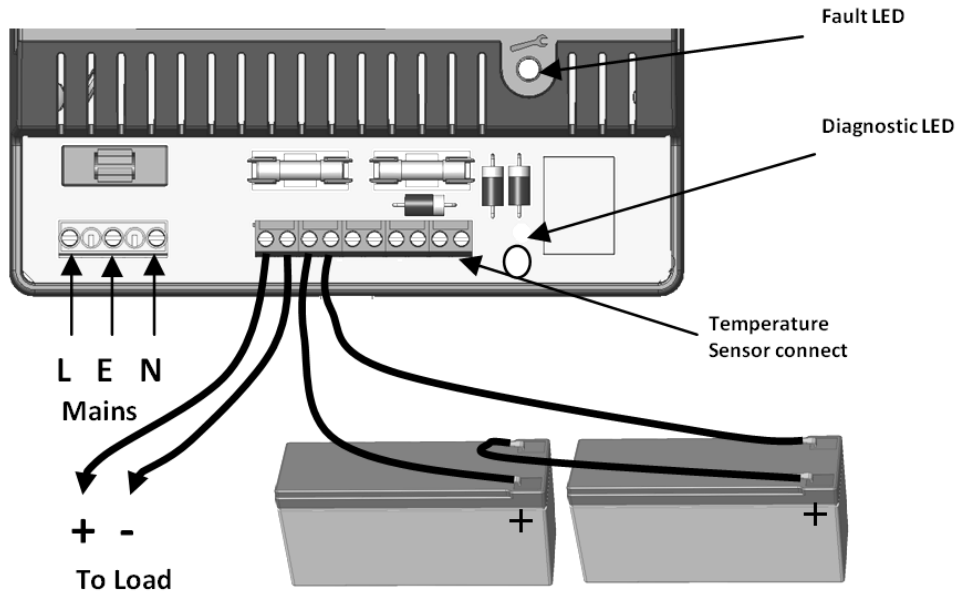

Figure 14: 5 Amp PSU shown

- With mains *disconnected*, connect the two 12 V standby batteries in series using the single cable provided. Connect the *negative* of one battery to the *positive* of the other. **DO NOT CONNECT** the other two battery terminals to each other.
- Connect the free Positive and Negative terminals of the batteries to the PCB terminals Batt+ and Batt - using the cables provided.
- Apply mains and, after the LED indicators initial start-up flash, verify that the yellow Fault LED does not flash (battery connection detected).
- Disconnect the mains power. Verify that the green Mains LED extinguishes and the yellows Fault LED starts to pulse (indicating that the PSU is running from its standby batteries).
- Verify that the EWCIE Front Control indicates a fault.
- Reconnect the mains. Verify that the green Mains LED illuminates and the yellow Fault LED extinguishes

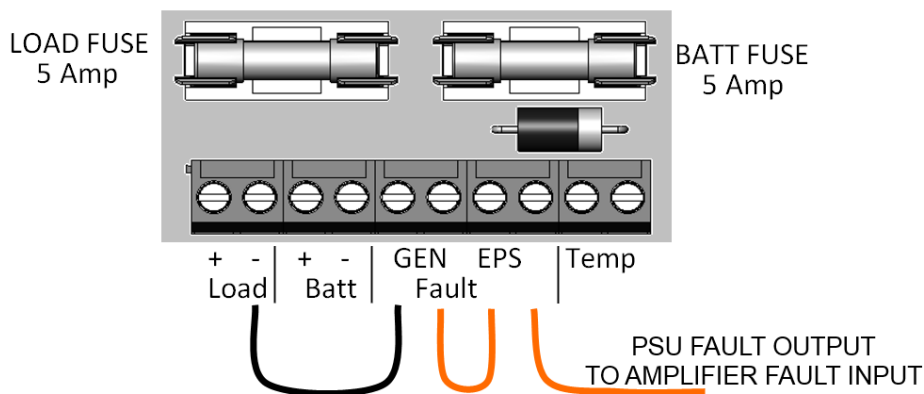



Figure 15: 5 Amp PSU Terminals shown

 **Note:** For the EWCIE to monitor PSU faults the PSU's GEN and EPS fault relays must be wired as per the image above and connected to an amplifiers External Fault Input 4.

 **Note:** For further 5A PSU specifications refer to MAN3086

10.4.3 10 Amp PSU

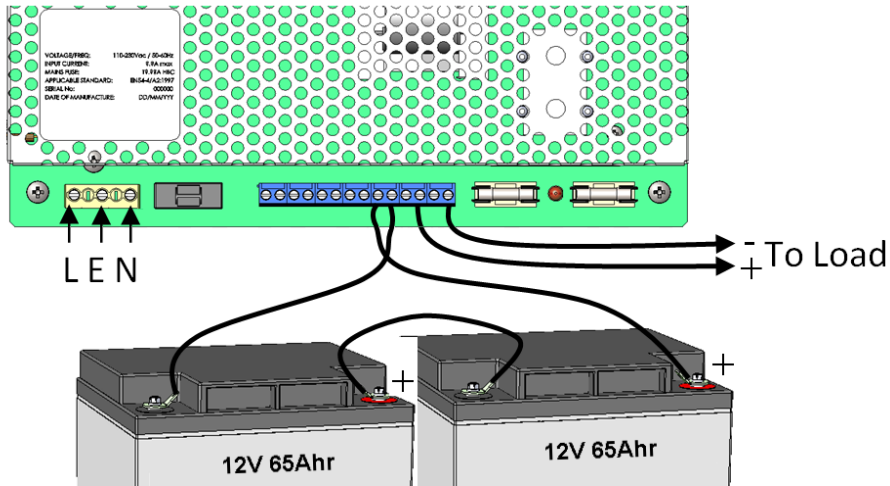

Figure 16: 10 Amp PSU shown

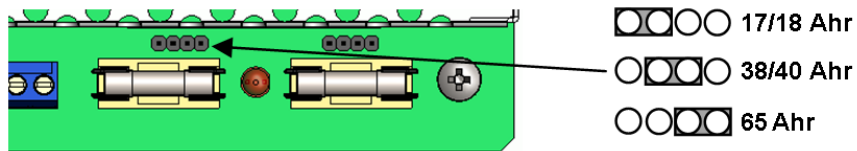

Figure 17: 10 Amp PSU Battery Selection Links

- Select the Battery type by placing the link (above the Battery fuse) in the appropriate location to select (17/18 Ah, 38/40 Ah or 65 Ah) batteries. This changes the maximum bulk charge current, and therefore enables higher load current to be used when smaller batteries are required. Put the link on the left hand two pins for 17/18 Ah, the middle pins for 38/40 Ah and the right hand two pins for 65 Ah batteries
- With mains *disconnected*, connect the two 12 V standby batteries in series using the single cable provided. Connect the *negative* of one battery to the *positive* of the other. **DO NOT CONNECT** the other two battery terminals to each other.
- Connect the free Positive and Negative terminals of the batteries to the PCB terminals Batt+ and Batt - using the cables provided.
- Apply mains and, after the LED indicators initial start-up flash, verify that the yellow Fault LED does not flash (battery connection detected).
- Disconnect the mains power. Verify that the green Mains LED extinguishes and the yellows Fault LED starts to pulse (indicating that the PSU is running from its standby batteries).
- Verify that the EWCIE Front Control indicates a fault.
- Reconnect the mains. Verify that the green Mains LED illuminates and the yellow Fault LED extinguishes

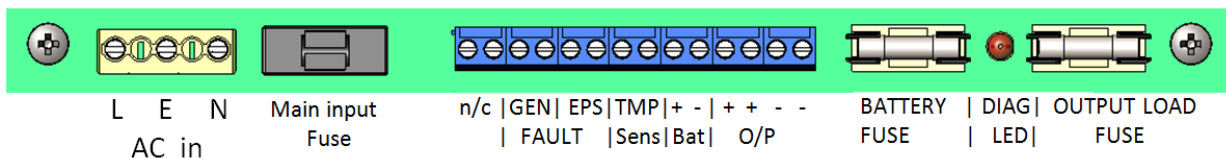

Figure 18: 10 Amp PSU Terminals shown

Note: For further 10A PSU specifications refer to MAN3087

10.5 Multiple Housing/Battery Box requirement

When there is a requirement for the Evacu EWCIE to be housed in more than one cabinet due to space limitations it is recommended that the Ampac battery box is used to accommodate the required system batteries.

In these situations it is imperative that the battery box is installed directly below or adjacent to the Evacu EWCIE cabinet to maintain AS4428:16 mechanical design compliance.

10.6 Connecting to OEM equipment

OEM equipment should be connected to the Standalone Evacu by interfacing to the amplifier’s Digital Inputs and Relay outputs.

The recommendation for connecting to the inputs is via volt free contacts and switching the Standalone Evacu’s +24V required for input 1 and the 0V (Com) required for inputs 2,3 and 4 as per the image below:

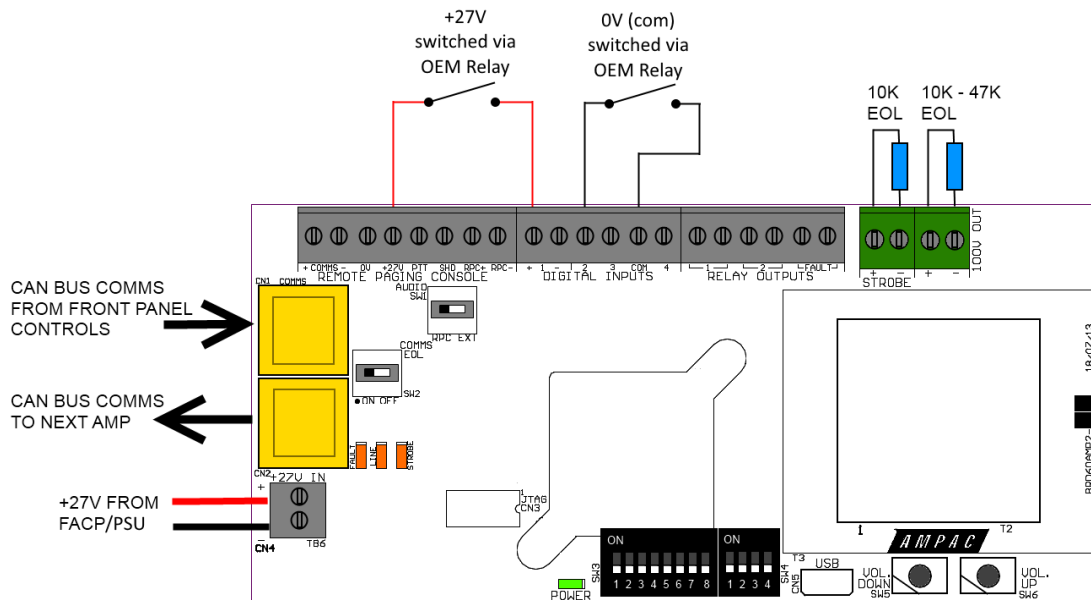

Figure 19: OEM interfacing

For all amplifier Inputs, Relays and Dip switch settings refer to the applicable tables in section five.

10.7 5 Amp & 10 Amp PSU Signalling and Diagnostics

10.7.1 Fault Outputs

| EPS Fault | GEN Fault | Condition | Possible Cause | Action |
|-----------|-----------|------------------|--|---|
| Closed | Closed | Normal operation | Mains present Battery healthy | None |
| Open | Closed | Standby Mode | Mains lost Battery driving load | Investigate loss of mains |
| Closed | Open | Fault Present | Blown fuses Battery fault Internal fault | Investigate fault source using diagnostic LED Rectify fault where possible |
| Open | Open | PSU Shutdown | Mains lost Standby battery exhausted | Restore mains as soon as possible |

10.7.2 LED Indication

| | |
|-------------|--|
| YELLOW LED | Fault LED |
| GREEN LED | Mains supply On |
| DIAGNOSTICS | Diagnostic LED (Not visible through front panel) |

10.7.3 Fault Diagnostic table – Front panel – User

| Yellow LED Fault | Green LED Mains | Condition | Possible Cause | Action |
|---------------------|-----------------|------------------|--|---------------------------|
| Off | On | Normal operation | Mains present Battery healthy | None |
| Flash Continuous | On or Off | Fault | Blown fuses Battery fault Internal fault | Contact service engineer |
| 1 Pulse | Off | Standby Mode | Mains lost Battery driving load | Investigate loss of mains |

10.7.4 Fault Diagnostic table – Internal - Engineer

| Orange LED Diagnostic | Green LED Mains | Condition | Possible Cause | Action |
|-----------------------|-----------------|---------------------------------|---|---|
| Off | On | Normal operation | Mains present Battery fully charged | None |
| | Off | Standby Operation | Mains Lost. No faults present Battery driving load | Investigate loss of mains |
| Flash Continuous | On or Off | No output | Output fuse blown Output overload Output short circuit | Check and replace output fuse Disconnect output load and test load |
| 1 Pulse | On | Battery Charging | No faults active Battery charging normally but < 90% of full charge | None |
| 2 Pulses | On | No Battery | Battery disconnected Battery fuse blown Battery heavily discharged | Check battery connections Check battery fuse Check battery condition Replace battery if aged |
| | Off | Low Battery Volts | Standby Mode Battery almost discharged | Restore mains |
| 3 Pulses | On or Off | Battery Fault | High impedance in battery connection Battery internal fault | Check battery connections for corrosion. Replace battery if aged |
| 4 Pulses | On or Off | Charger Fault | Internal failure of battery charger | Return to manufacturer |
| 5 Pulses | On or Off | Battery Temperature Probe Fault | Battery temperature monitor disconnected or damaged PSU running in Safe Mode | Check temperature sensor connections and condition of sensor. Replace if suspect |

10.8 6050-0008 EvacU Standalone Isolation 50W Amplifier

(NOTE: ONLY FOR USE ON EV3000 AND EV100 AMPLIFIERS)

Where there is a requirement that an isolated amplifier is required the Standalone Isolation amplifier can accommodate most instances. This unit connects to an EV3000 100V amplifier line circuit and reproduces the signal produced using a battery backed 50w amplifier mounted inside the remote cabinet. It can be used for secure line applications or to add additional capacity to an already loaded circuit.

The internal 100V output line is monitored for shorts and interruptions. Any fault present within the standalone system will be transferred to the 100V source input line via a switching resistor.

A local background music input is provided on the isolation amplifier for individual tenancy applications. This allows the installer to have background music playing on the remote isolation amplifier zone. In the event of the source 100V line being triggered the background music will be switched out for the priority of the source

100V line. (**NOTE: Line monitoring for 120W amplifiers is only compatible with amplifiers manufactured post 2016**)

Output volume and VOX Input sensitivity can be adjusted via the pots on the 100V to line level convertor.

Output Volume

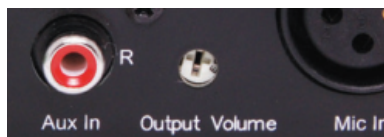

Input VOX Sensitivity



For instructions on mains connection and power up please follow **Section 10.4.2 - 5 AMP PSU**

For field connections see below drawing.

10.9 6050-0008 EvacU Standalone 50W System Drawing

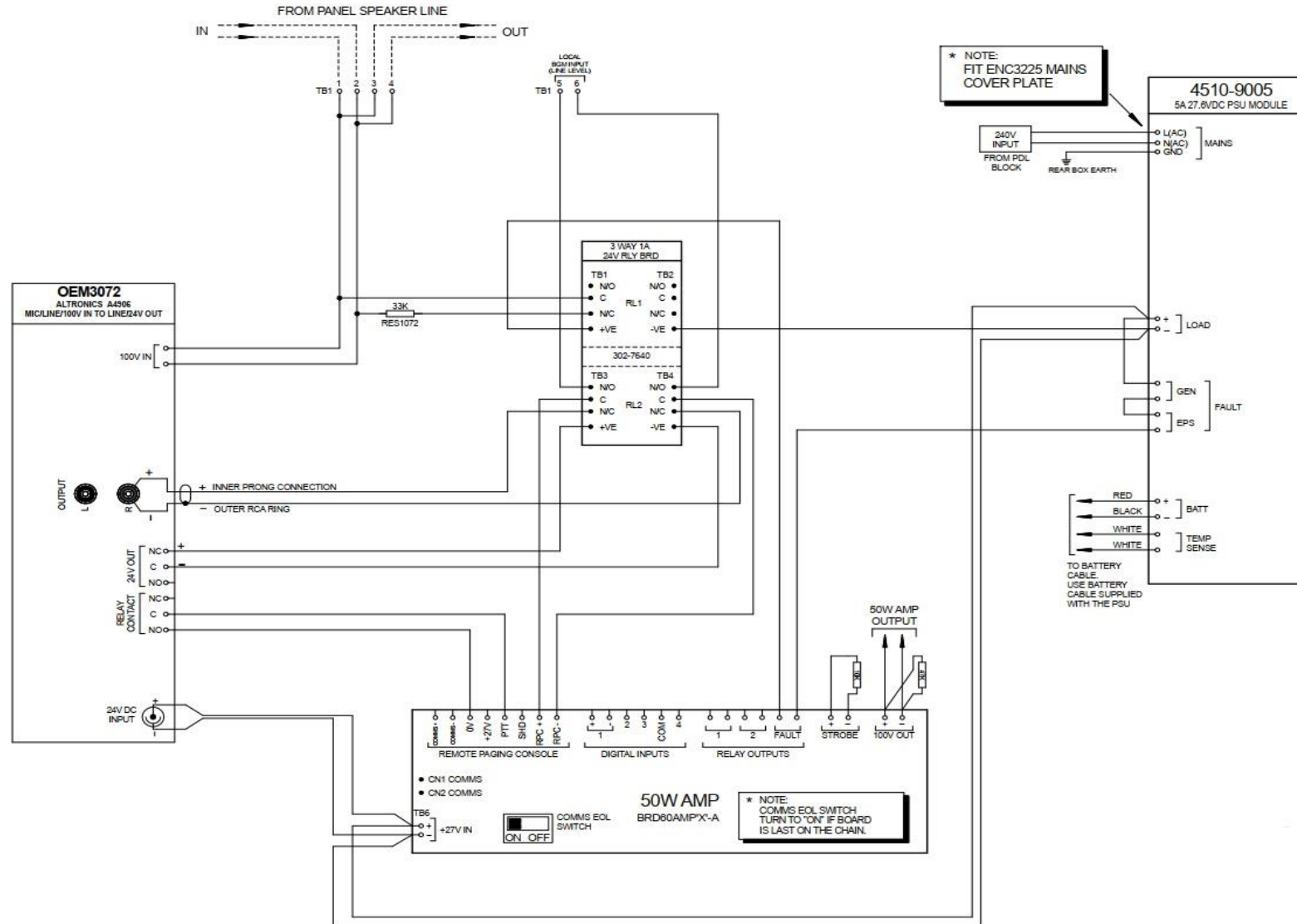

11 Fire Panel Interfacing

11.1 FireFinder 25W and 50W

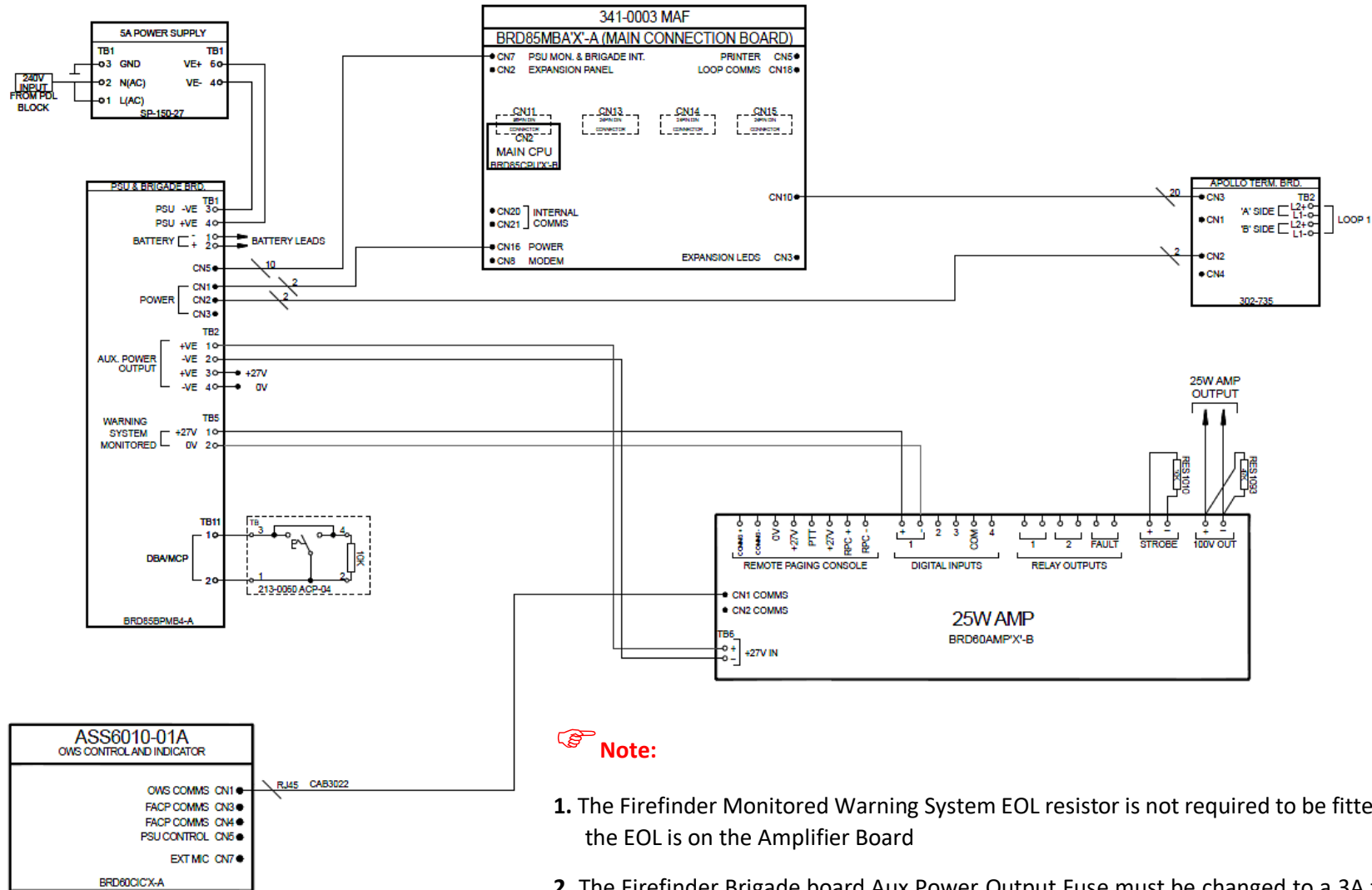

Note:

1. The Firefinder Monitored Warning System EOL resistor is not required to be fitted as the EOL is on the Amplifier Board
2. The Firefinder Brigade board Aux Power Output Fuse must be changed to a 3A fuse when using the 25W and a 4A fuse for the 50W.

11.2 FireFinder plus 25W and 50W

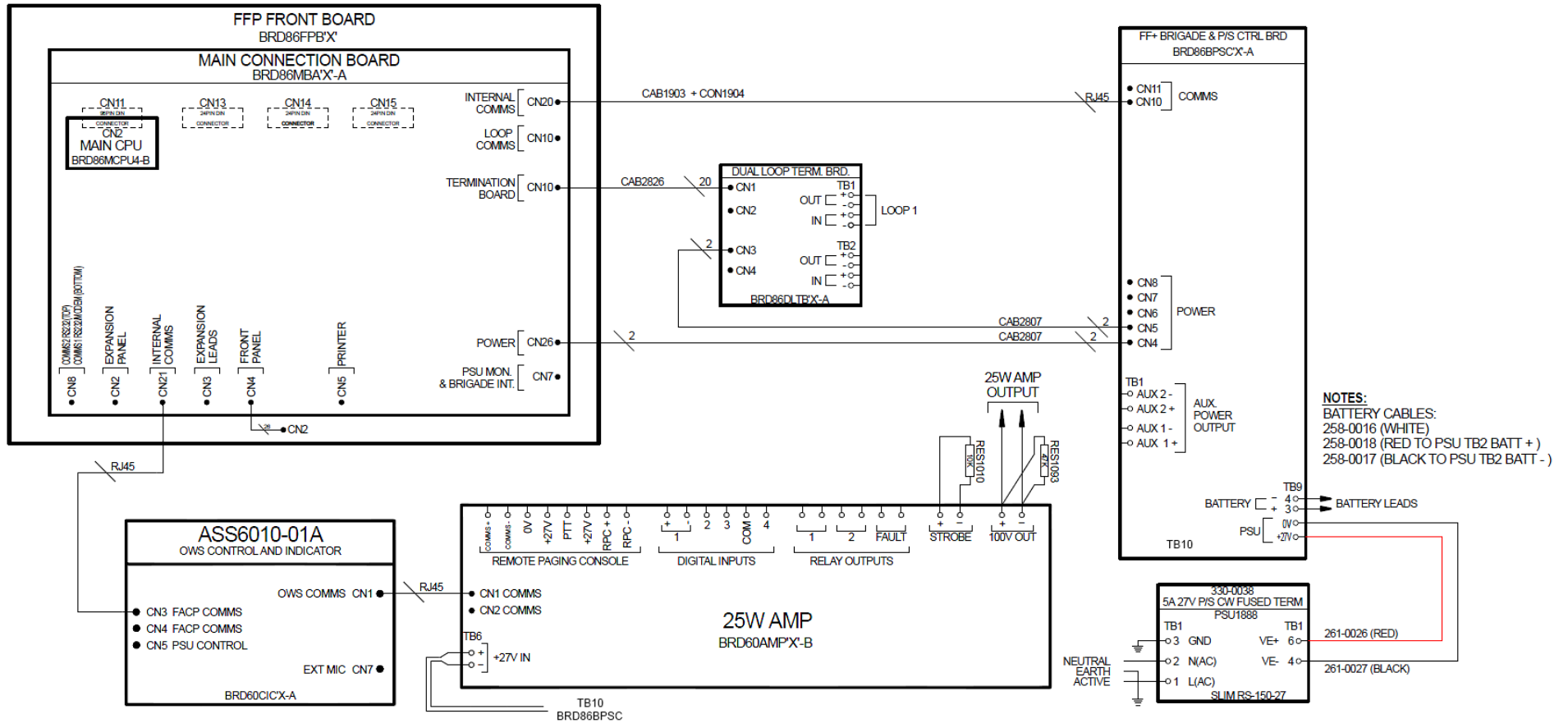

11.3 LoopSense 25W and 50W

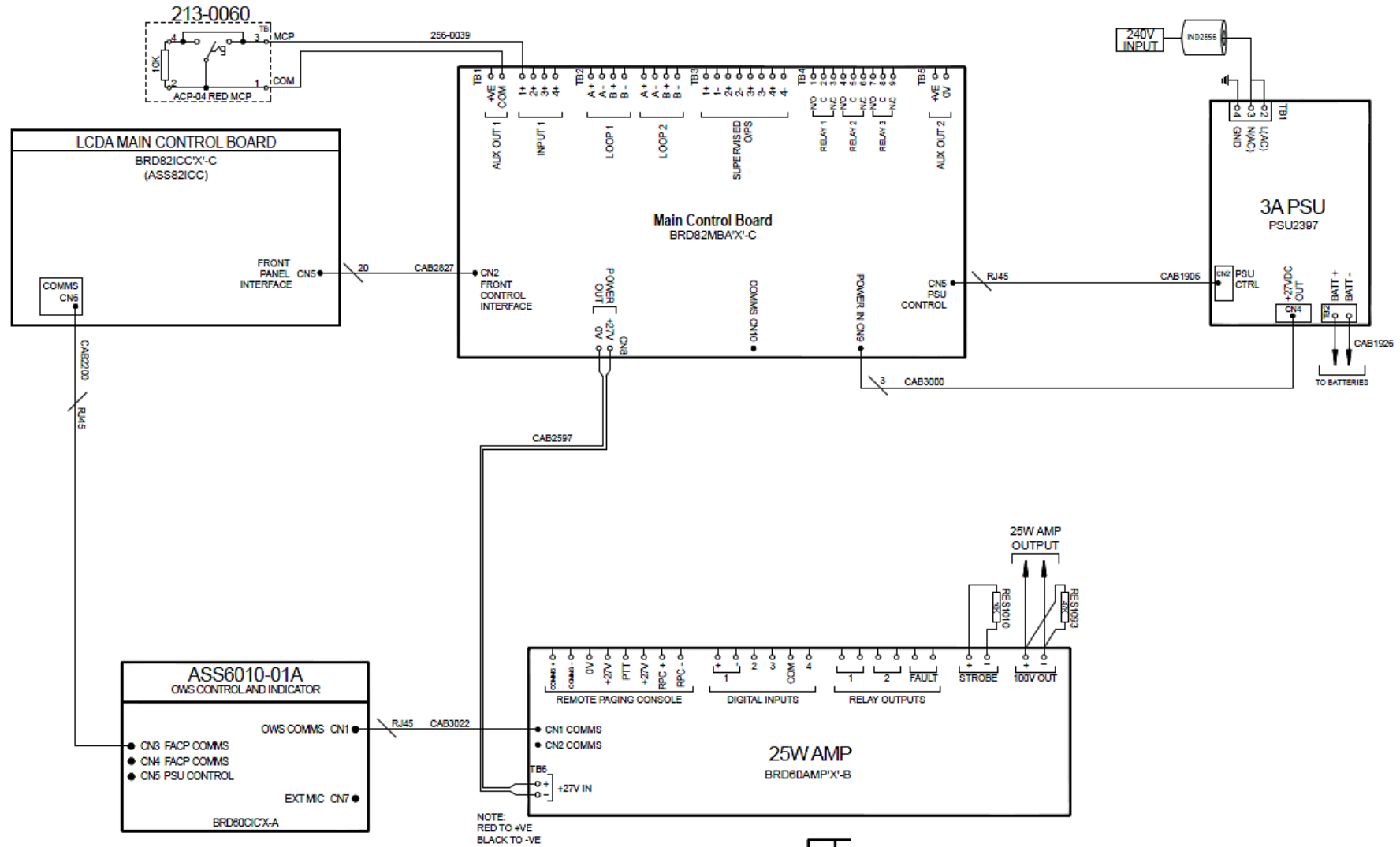

11.4 ZoneSense Plus 25W

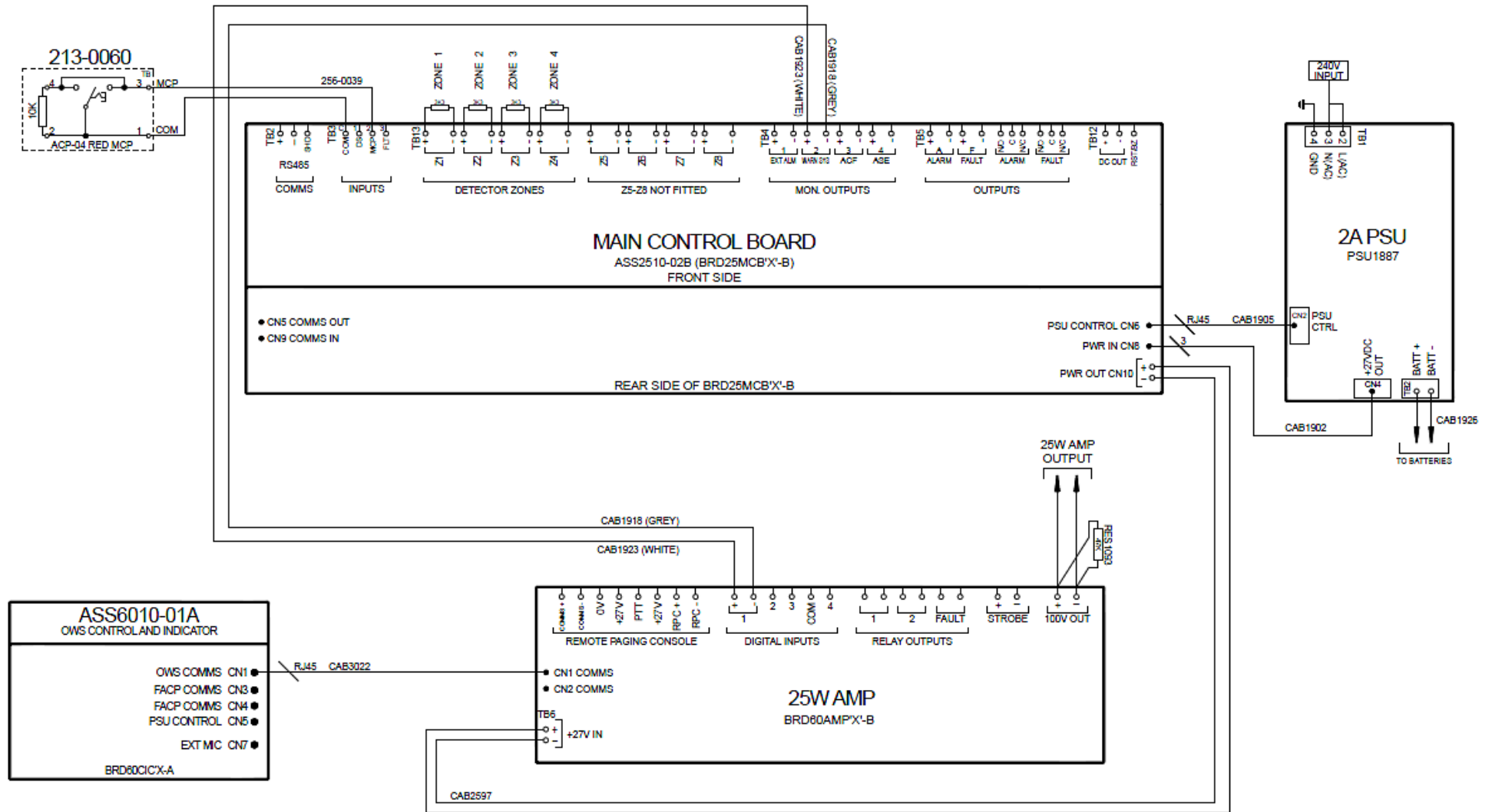

Note: The Zonesense Plus Monitored Warning System EOL resistor is not required to be fitted as the EOL resistor is on the Amplifier.

11.5 Multiple Amplifiers – LoopSense & FireFinder Plus

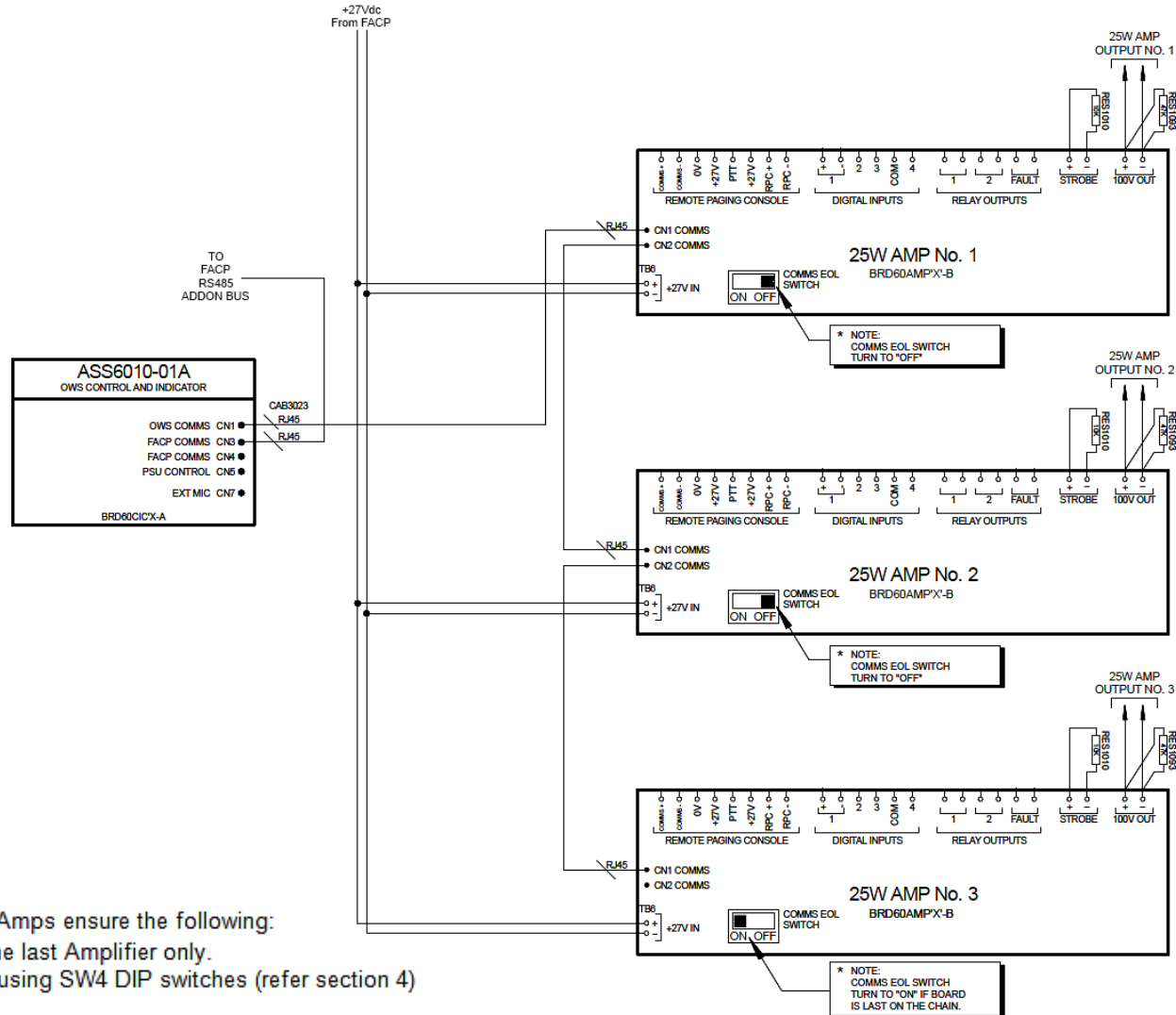

Note: When using multiple Amps ensure the following:

1. The EOL Switch is "ON" on the last Amplifier only.
2. Each Amplifier is addressed using SW4 DIP switches (refer section 4)
3. Maximum of 8 Amplifiers

11.6 Multiple Amplifiers – FireFinder

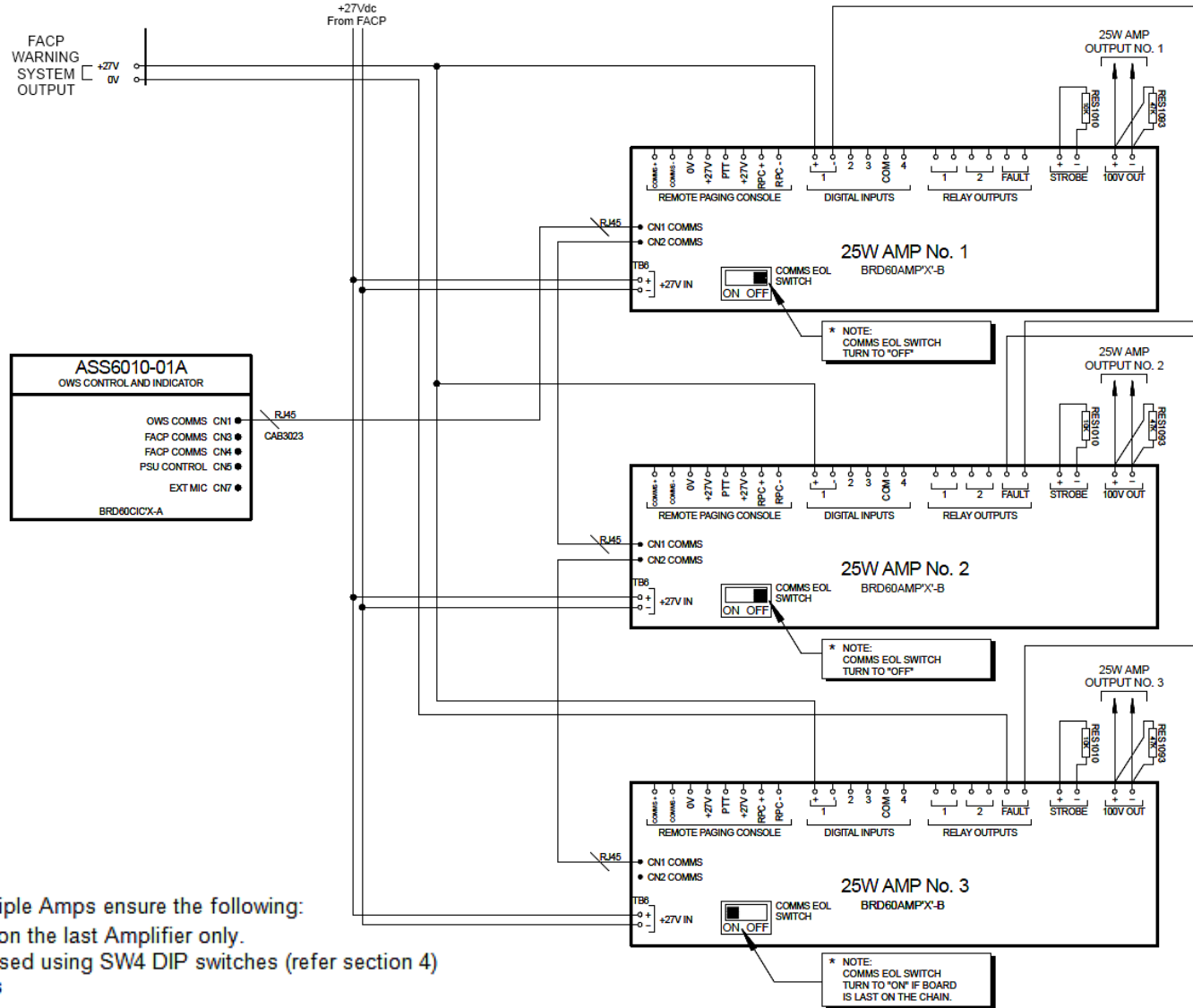

- Note:** When using multiple Amps ensure the following:
1. The EOL Switch is "ON" on the last Amplifier only.
 2. Each Amplifier is addressed using SW4 DIP switches (refer section 4)
 3. Maximum of 8 Amplifiers

11.8 Paging using Evactron 8 Zone RPC with Multiple Amps

Example below uses the Evactron ZL-0008 8 Zone Paging Mic and decoder (Navision item code PAGE8LMIC)

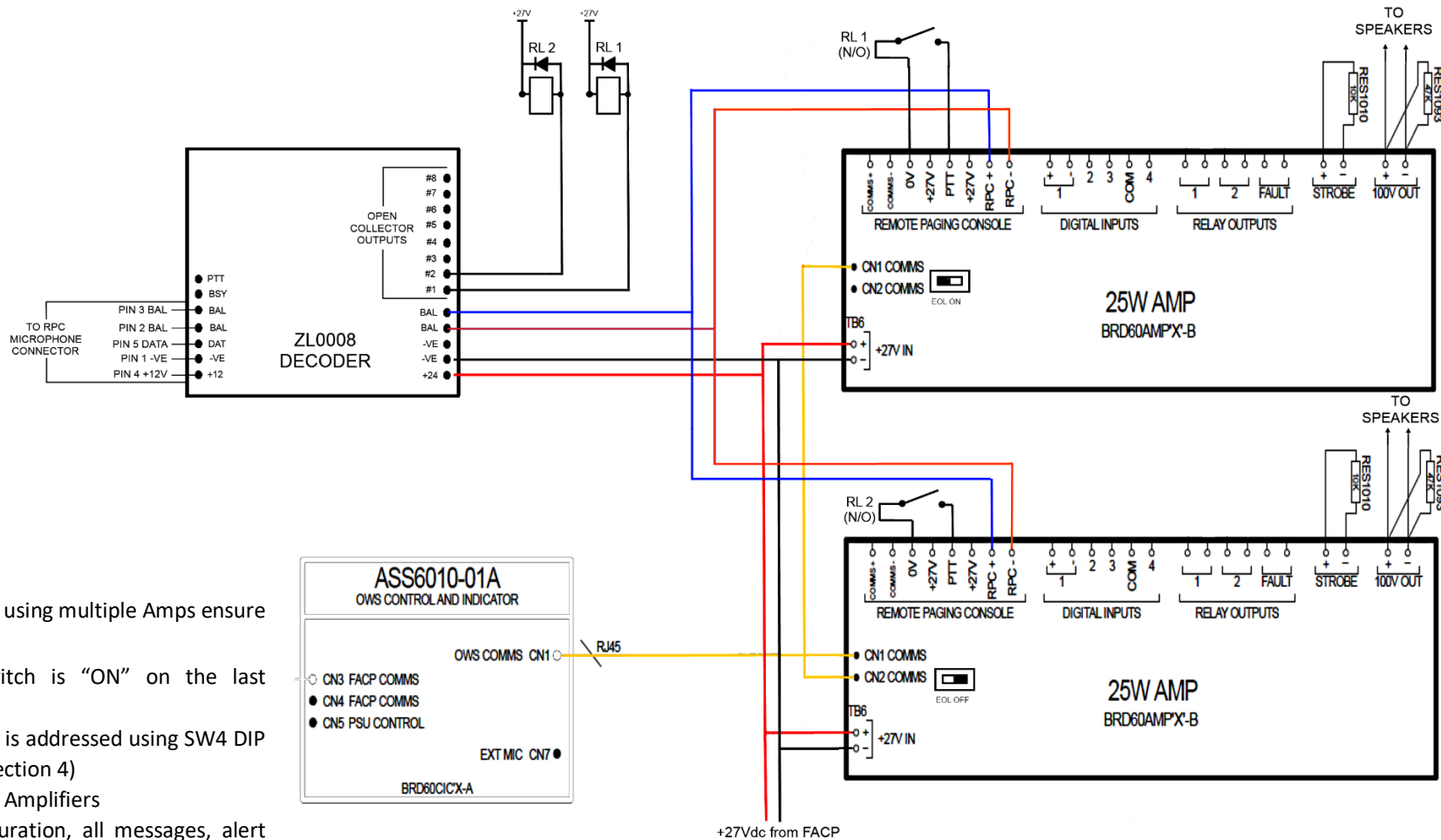

Note: When using multiple Amps ensure the following:

1. The EOL Switch is "ON" on the last Amplifier only.
2. Each Amplifier is addressed using SW4 DIP switches (refer section 4)
3. Maximum of 8 Amplifiers
4. In this configuration, all messages, alert single, evacuation signal etc are ALL CALL

11.9 Paging using 157-0001 Single Zone Paging MIC with BGM

The image below shows one paging MIC wired into two amplifiers with a single BGM input.

Note the use of the 302-475D pre-amp when using the 1 Zone paging MIC. The 302-475D is not fitted in the MIC.

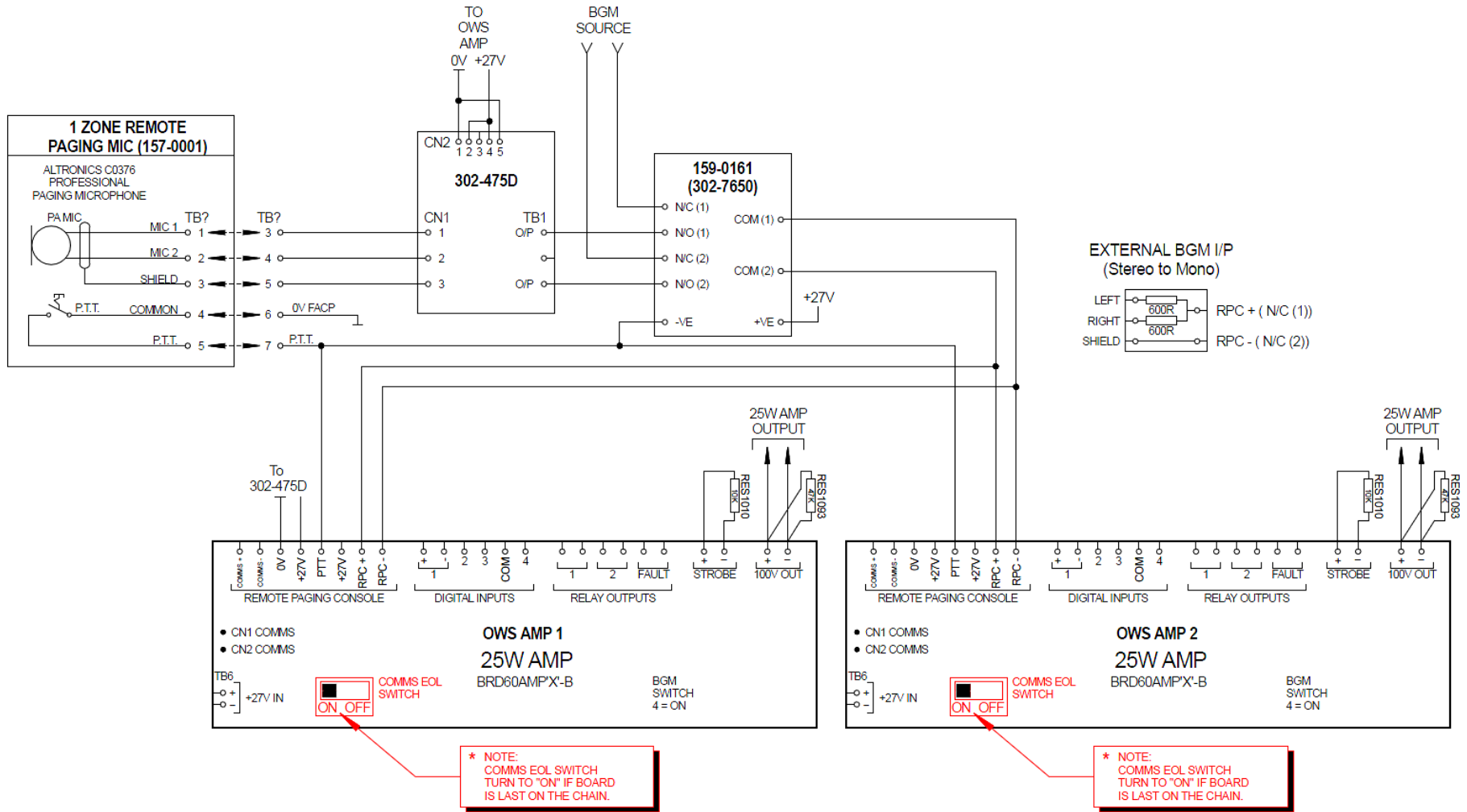

11.10 50W OWS Interfacing to Evactron LMU4

To interface a LMU4 (159-0274 / OEM2179) to the 50W or 25W OWS an interface board must be used. The interface Board kit number is 6010-0011 and does not include the LMU4.

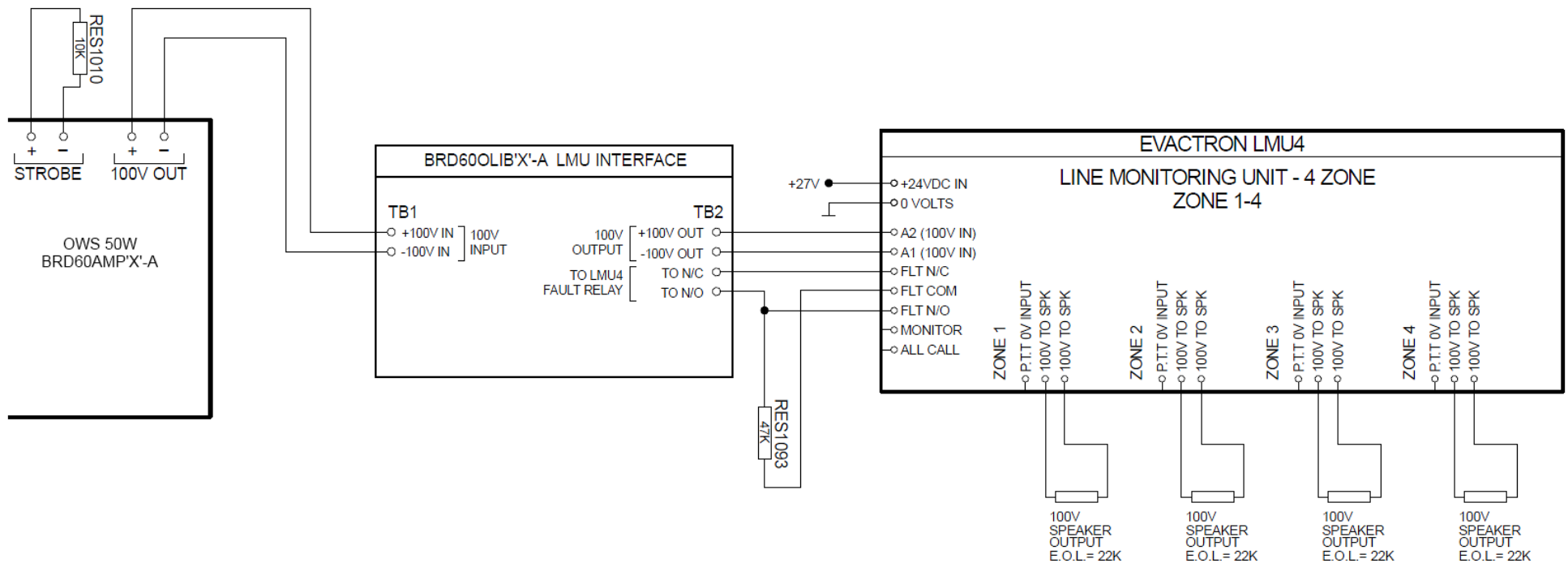

11.11 120W, 250W & 500W Interfacing to Evactron LMU4



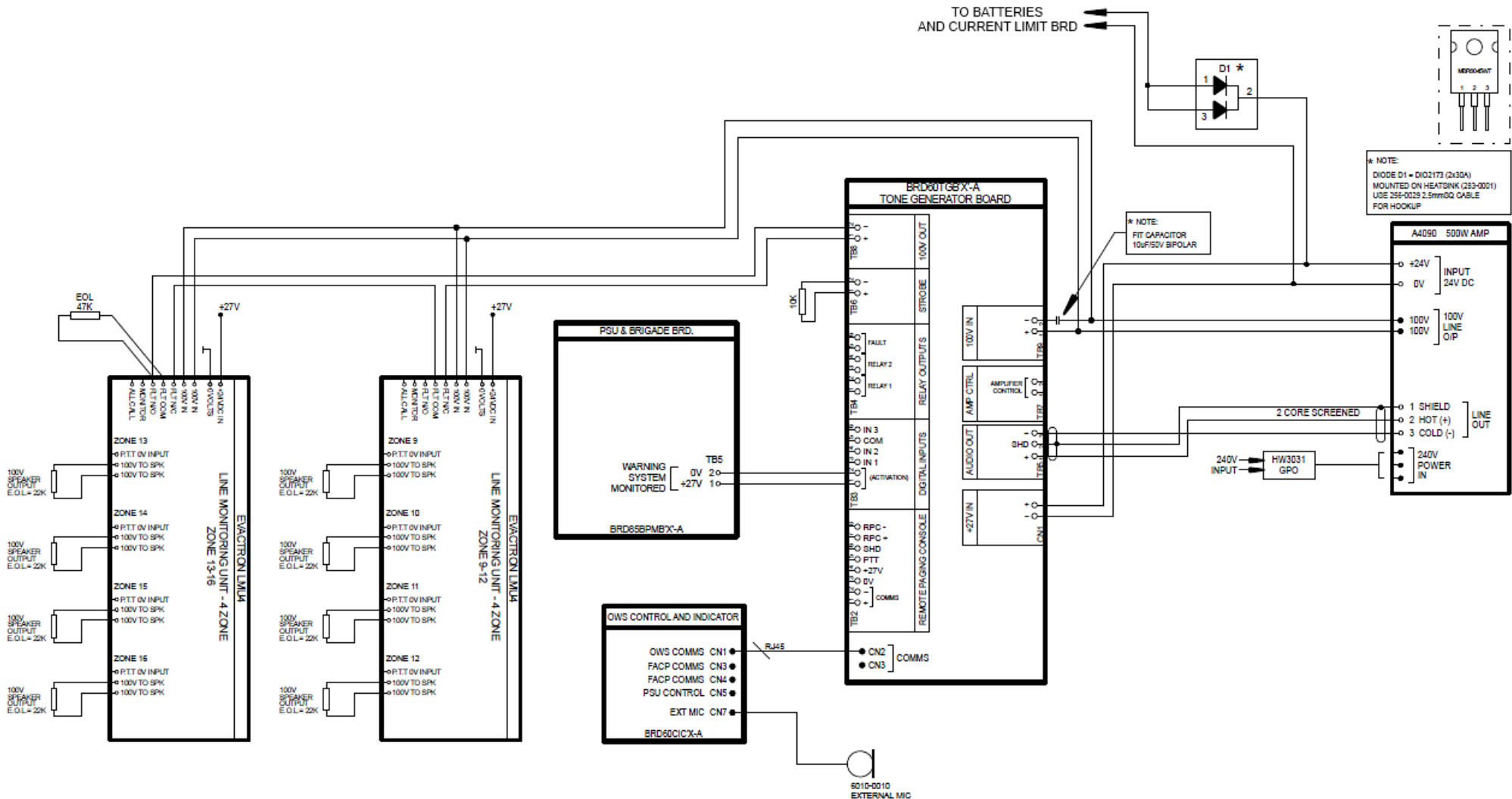







The image below shows how to interface LMU4 to the 120W, 250W and 500W OWS using the Tone Generator board. Note the 6010-0011 Interface is not required.



11.12 120W, 250W and 500W Interfacing

For interfacing details for the 120W, 250W and 500W amplifiers refer to the applicable wiring drawings that can be made available from your local Ampac CSO office.

Applicable drawings are as follows:

-  6010-005 (250W OWS).pdf
-  6010-0013 (1X OWS SPLITTER) + 6010-005 (250W OWS).pdf
-  6010-0013 (1X OWS SPLITTER) + 6010-0006 (500W OWS).pdf
-  6010-0013 (1X-2X OWS SPLITTER) + 6010-0004 (120W OWS).pdf
-  6010-0013 (2X OWS SPLITTER) + 6010-005 (250W OWS).pdf
-  6010-0013 (2X OWS SPLITTER) + 6010-0006 (500W OWS).pdf
-  6010-0013 (3X OWS SPLITTER) + 6010-0004 (120W OWS) NON-CANBUS.pdf
-  6010-0013 (3X OWS SPLITTER) + 6010-005 (250W OWS) NON-CANBUS.pdf
-  6010-0013 (3X OWS SPLITTER)+ 6010-0006 (500W OWS) NON-CANBUS.pdf
-  6010-0013 (6X OWS SPLITTER)+ 6010-0006 (500W OWS) NON-CANBUS.pdf

At least one Audio Line Splitter must be used when a 500W amplifier is installed to allow the full use of the 500W.

12 Configuring the EWCIE using LoopMaster and FireFinder PLUS ConfigManager

12.1 FireFinder PLUS ConfigManager

To add a EWCIE to the FireFinder PLUS, the following steps are required:

Add a EWCIE Front Panel to the Configuration

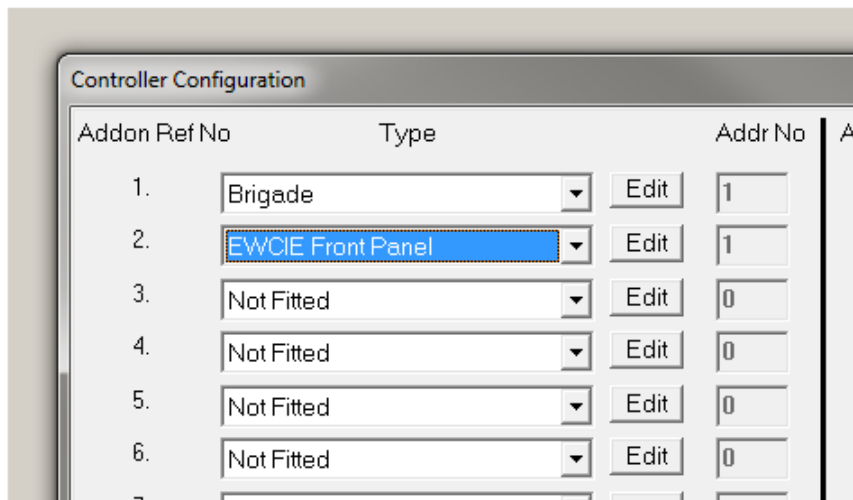

Depressing the Edit field, the following dialogue box is displayed

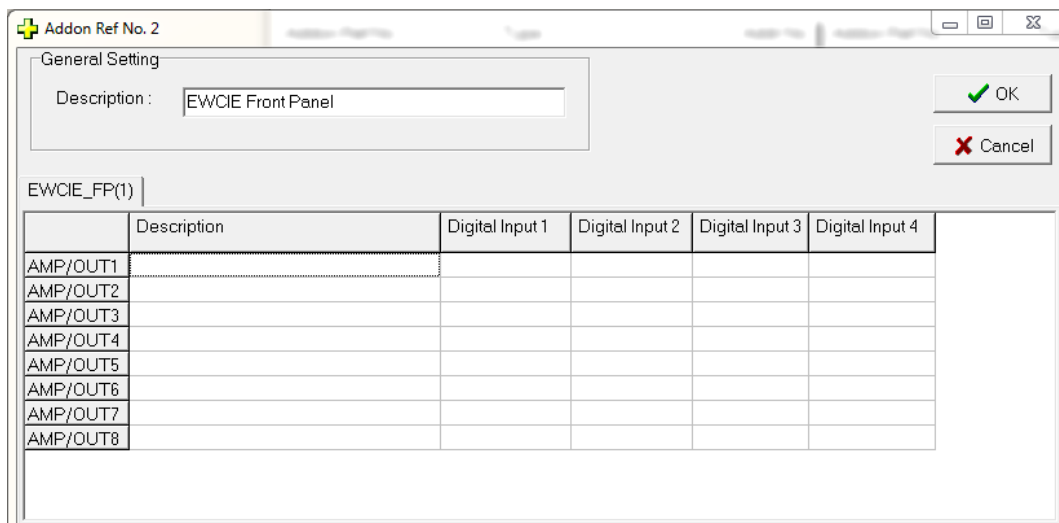

This dialogue box has the following fields:

- Description string for the EWCIE Front Panel
- Description string for each amplifier (up to eight)
- Digital Input 1 is the condition to assert input #1 of the selected amplifier via the Add-On and CAN bus (refer to section 5.2)
- Digital Input 2 is the condition to assert input #2 of the selected amplifier via the Add-On and CAN bus (refer to section 5.2)
- Digital Input 3 is the condition to assert input #3 of the selected amplifier via the Add-On and CAN bus (refer to section 5.2)
- Digital Input 4 is the condition to assert input #4 of the selected amplifier via the Add-On and CAN bus (refer to section 5.2)

To input a condition to activate each of the inputs, the following dialogue box is used:

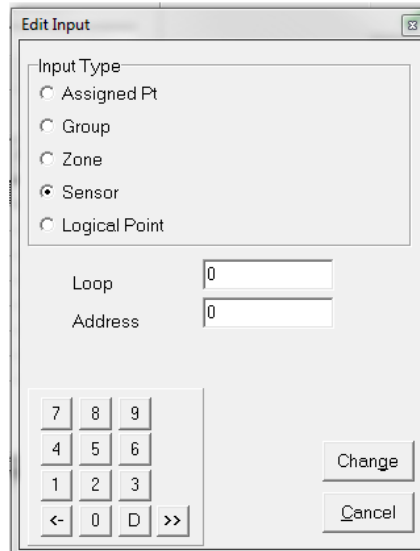

This dialogue box allows assigned points, group, zone, sensor or logical to be assigned to activate the selected input.

The EWCIE can be programmed to respond to an alarm signal in **two** ways.

The **first** way is to **ONLY** use the alarm signal (input #1 – section 5.2). How the EWCIE reponds is determined by switches 5, 6 and 7 of the 8 way DIP switch (section 5.6). Switch settings 000 thru to 110 support 7 different settings, from evacuate signal only, alert signal (for a preset timeout) and then the evacuate signal or alert signal only. The EWCIE will broadcast the selected signal (as per switches 5, 6 and 7), when the condition in the Digital Input 1 is true.

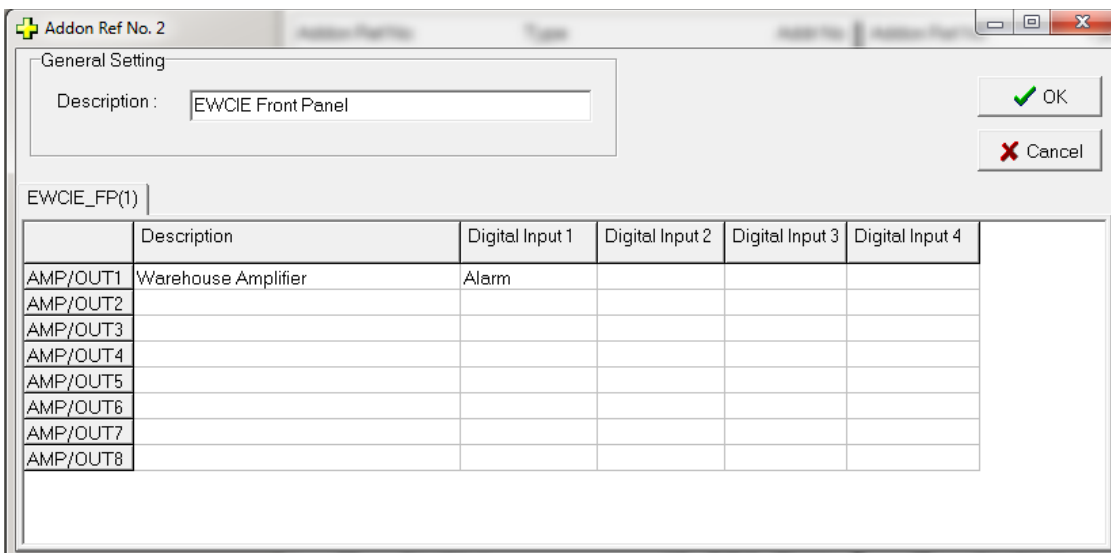

The **second** way is to use all inputs by setting Dip Switches 5, 6 and 7 to On.

This allows the fire alarm control panel to control when and what signal is broadcast depending on how the inputs have been configured in the EvacUwiz. When the conditions specified in the dialogue box are met, the EWCIE will broadcast the appropriate indication, message or tone.

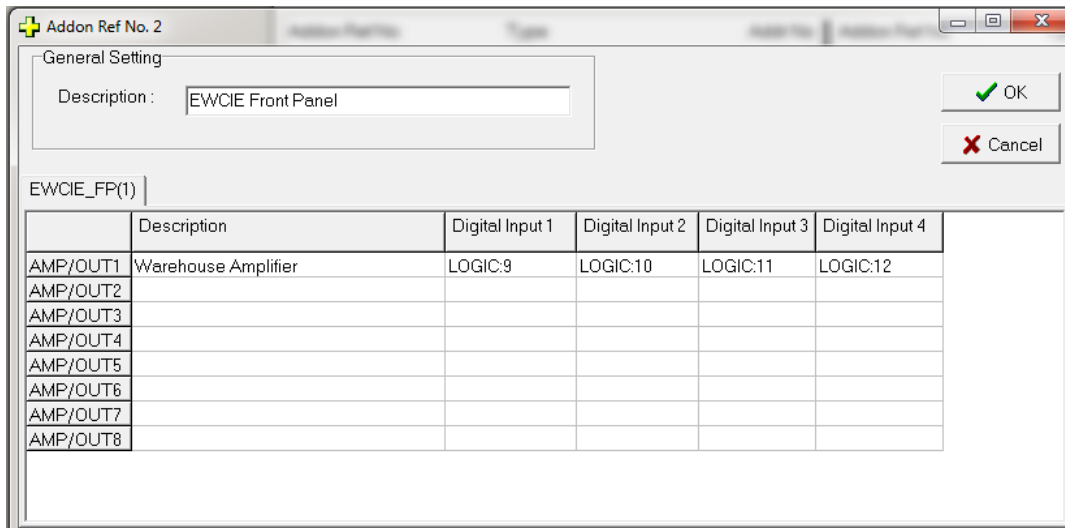

All eight amplifiers are treated individually. Hence it is possible to implement an ALL CALL type system or a basic phased evacuation (cascading system) by using functions with timers.

The alert and evac indicators are All Call (when multiple amplifiers are fitted) as described in section 4.3. If implementing a basic phased evacuation system, a 32 way indicator will need to be added to show which signals are being broadcast. The same activation conditions used to trigger the amplifier shall be used to trigger the indicator.

12.2 LoopMaster

The EWCIE Front Panel is added to the LoopSense (as per any other Add On)

The following dialogue box is displayed to edit the EWCIE.

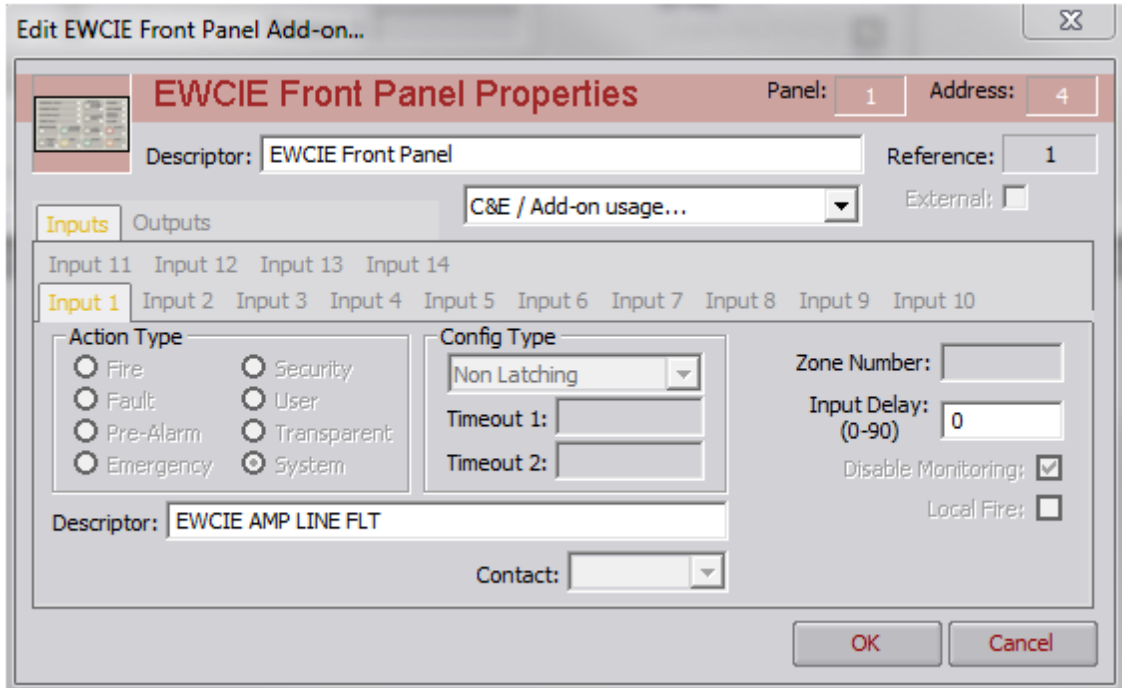

There are 14 inputs available. These are:

- Amplifier line fault
- Strobe fault
- Microphone fault
- Mains power fault (stand alone EWCIE only)
- Battery missing fault (stand alone EWCIE only)
- Charger fault (stand alone EWCIE only)
- Battery fault (stand alone EWCIE only)
- EWCIE System fault
- EWCIE General fault
- EWCIE power supply fault (stand alone EWCIE only)
- Lockdown message broadcast
- System test message broadcast
- False alarm message broadcast
- In test mode

The above inputs are available to use as CAUSES in the Cause and Effect

The inputs marked as fault are reported by LoopSense (and will raise a fault condition on the LoopSense)

The following shows the outputs

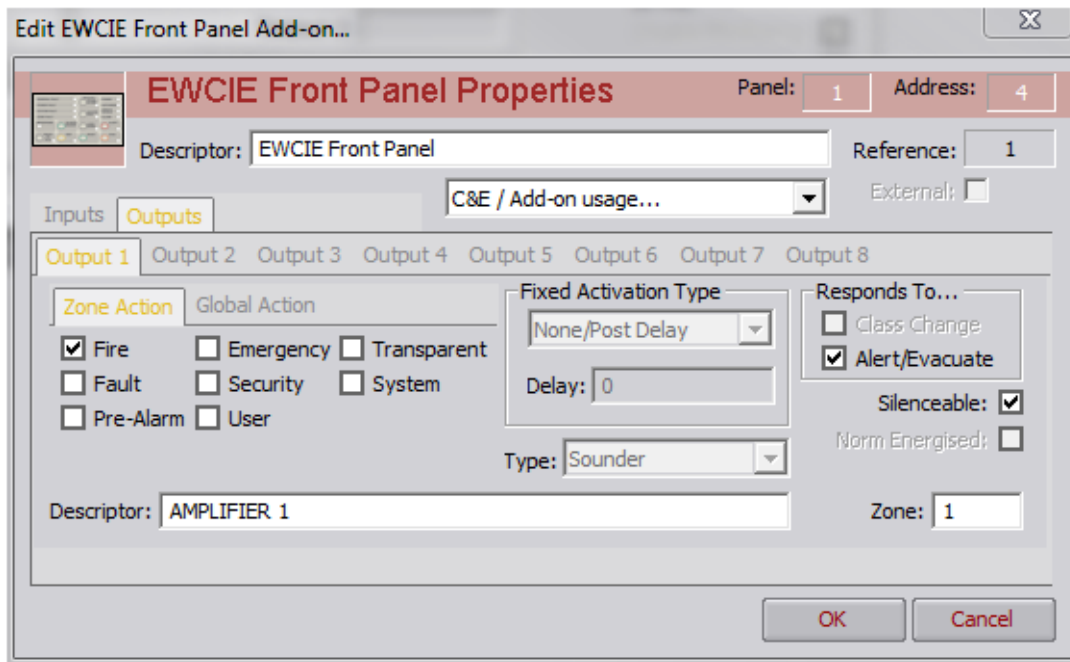

There are 8 outputs, one per amplifier.

The amplifier can be programmed for zone and global action.

For zone action, the fire zone that will activate the amplifier is shown in the bottom right hand corner of the dialogue box. This field is editable. The action type can be set by the tick boxes. Normally the EWCIE will be activated by a Fire action type.

The global action, only an action type is specified. Most EWCIE will be assigned global Fire.

All other fields on the dialogue box have no impact.

Each amplifier is activated according to the DIP switch setting in section 5.6 – except setting 7 (111) is **NOT** supported.

For more specialised programming, the amplifiers can be programmed via cause and effect.

Each amplifier can be programmed to be activated by a cause (the same as any other output in the system).

The following dialogue box shows an instance of a cause and effect.

Zones 1, 2 and 3 will cause Amplifier 1 to operate. The amplifier will activate the Alert and Evac tones/messages according to the DIP switch settings (section 5.6)

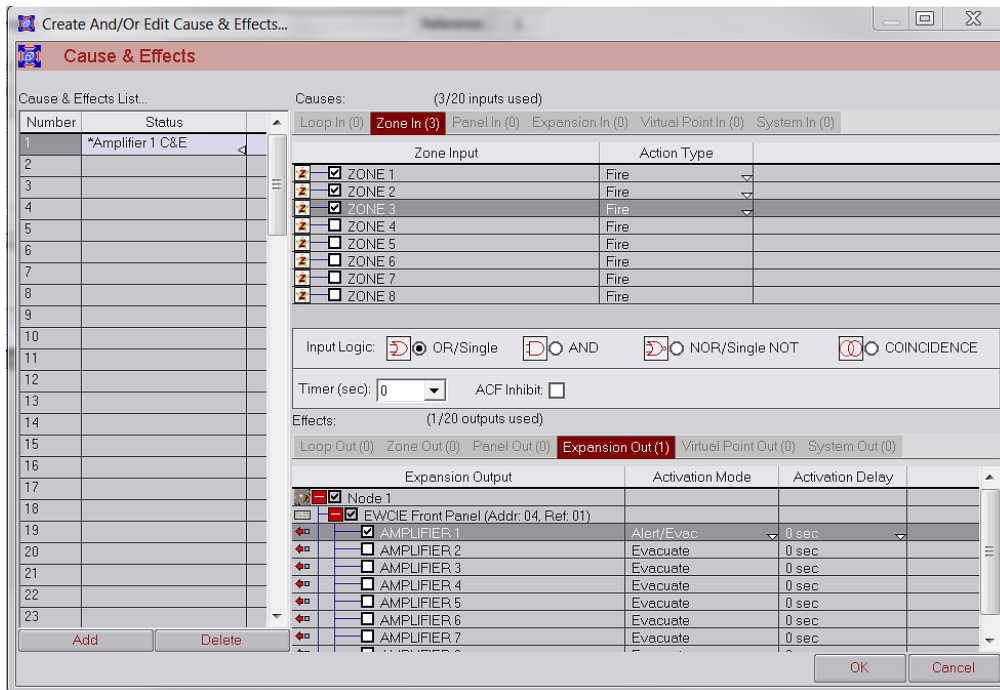

The Timer field in the middle of the dialogue box is an activation delay that applies to all amplifiers.

The Activation delay in the table – applies individually to an amplifier. This individual activation delay does allow phased evacuation sequences.

For the LoopSense to be able to control when the digital inputs are set to options other than the default, it is necessary to set the DIP switch 5, 6 and 7 to (111) and provide additional hardwired outputs to control the inputs.

These additional outputs will need to be programmed.

13 EvacUwiz Programming Tool

The **EvacUwiz** programming tool is a Windows configuration software and is used to construct a configuration 'file', suitable for 'programming' the Evac-U series of OWS devices (amplifiers and/or tone generators), and for the creation and editing of relevant sound libraries, as well as for real-time interrogation and interaction of the OWS devices. Refer to MAN3084 OWS Programming Manual for further details.

14 Maintenance

The *EvacU EWCIE* should be maintained so as to comply with all standards / regulations applicable to the country and location it has been installed. Failure to do so could put at risk compliance and the integrity of the system. As a minimum it is recommended the following be used as a guide to periodic maintenance especially if there is an absence of standards regulations.

General

To implement a site maintenance regime, responsibilities should be established by responsible persons, training implemented if required, maintenance delegates appointed and all outcomes clearly communicated to all parties.

Daily Operations (operator level)

- The delegated operator checks for normal operation
- If any faults are detected, record them in an established “Site Log Book” and report them to the assigned body.
- Ensure all faults are signed off as they are resolved and follow up on those that are still outstanding.

Monthly Operations (operator level)

- In addition to Daily Operational checks
- Visually inspect in and around the panel for any signs of pests, moisture or general damage
- Conduct a System test section 4.5.4 or applicable tests defined in Section 4.5.3 of this manual.
- Ensure the Site Log Book” is up to date, faults have been attended to and the latest test are recorded

Quarterly Operations (service contractor)

- In addition to Monthly Operational checks
- Check all internal connections and perform site specific tests. Refer test options defined in section 4.5.3 of this manual as a guide.
- Perform a “walk around” of the site to determine if the system integrity is free of possible faults
- Ensure the Site Log Book” is up to date, faults have been attended to and the latest test are recorded

Annual Operations (service contractor)

- In addition to Monthly Operational checks
- Initiate both a “lamp” test (section 5.7) and any other tests as determined necessary for the site.
- Inspect and test (as per the manufacturers specifications) batteries
- Ensure the Site Log Book” is up to date, faults have been attended to and the latest test are recorded

Replacement Components (service contractor)

Batteries and fuses are seen as the only field replaceable components.

If a board field change is required all necessary anti-static precautions must be taken.

15 Trouble Shooting

i Resolution of all suspected faults MUST only be carried out by suitably qualified technical operatives.

| Problem | Solution |
|---|---|
| Power Fault illuminated | Check PSU output voltage it should be set to 27.6V (Nominal). Check mains Check the battery has been connected properly Refer section 10 for fault diagnosis |
| Earth Fault LED illuminated on Amplifiers | Check all input and output cabling and wiring assemblies for short to ground |
| System Fault LED illuminated | Ensure correct panel configuration Check DIP switch settings Check cable connections between control board and amplifiers |
| General Fault illuminated | Check amplifier 100Vac speaker line and Strobe line. |
| | |

16 Certification Information

The **Evacu EWCIE** is designed and manufactured by:

AMPAC TECHNOLOGIES PTY LTD

7 Ledger Rd

Balcatta

WA 6021

Western Australia

PH: 61-8-9242 3333

FAX: 61-8-9242 3334



Manufactured to:

Certificate of Compliance Number:

Equipment Serial Number:

Date of Manufacture:

UNCONTROLLED DOCUMENT

NOTE: Due to AMPAC's commitment to continuous improvement specifications may change without notice.